



# A practical design guide to lower carbon healthier homes

June 2024



Case study: Bader Ventura Apartments, Mangere, Auckland, 7 Homestar.v5\_Architects Peddlethorpe.



# Contents

## 1 About this guide

## 3 Introduction

How to use this guide

Links

High performance design workflow vs traditional workflow

An introduction to energy modelling

## 7 Homestar v5 design workflow

ECCHO

HECC

## 11 Using the results

A worked example

## 13 Case studies

How to use this section

What if I want to do better?

Performance considerations for all typologies

Mandatory minimums

## 16 Case study 1 - Single storey standalone house - low glazing

Performance considerations for case study 1

Case study 1 - Specification

Case study 1 - Results

Case study 1 - Costing

## 24 Case study 2 - Single storey standalone house - high glazing

Performance considerations for case study 2

Case study 2 - Specification

Case study 2 - Results

Case study 2 - Costing

## 32 Case study 3 - Multi-unit two storey terraced homes

Performance considerations for case study 3

Case study 3 - Specification

Case study 3 - Results

Case study 3 - Costing

## 41 Case study 4 - Multi-unit apartments

Performance considerations for case study 4

Case study 4 - Specification

Case study 4 - Results

Case study 4 - Costing

## 49 Moisture control

Why?

Thermal bridging

The psi value

The fRsi

2D and 3D thermal bridges

How to use the High Performance Construction Details Handbook

Where can thermal bridges occur?

Slab edge thermal bridges

Options to insulate slab edges and connections

Steel connections to slabs

Footings for masonry cladding and wing walls

Slab junctions between treated & untreated spaces

Steel columns, portals and beams

Roof perimeter insulation

Airtightness

## 61 Assemblies

Why?

Included assemblies

A note on framing ratios

Things to look out for

Walls - 90mm timber framing

Walls - 140mm timber framing

Walls - SIPs

Walls - exterior insulation over timber framing

Walls - exterior insulation over metal and concrete

Walls - exterior insulation over CLT

Floors - suspended timber

Floors - concrete flat slab

Floors - concrete waffle pod slab

Roof - SIPs

Roof - timber rafter skillion

Roof - timber trusses and insulation at ceiling level

Roof - metal purlins and exterior insulation

Roof - timber purlins and exterior insulation

Roof - flat roof, warm roof

Roof - flat roof, cold roof

Windows

## 83 Embodied carbon and life cycle assessment overview

Why?

The bigger picture:

How HECC can help us reduce embodied carbon emission

The 'big four'

Worked examples

On-site greenhouse gas emissions

## 90 Fundamentals of overheating

Shading - its importance and how to quantify it

Accounting for shading in ECCHO

ECCHO shading percentage categories

Worked example 1

Worked example 2

Glass Selection

Summer window ventilation and night purging

Overheating - other impacts

## 102 Controlling the interior environment

Positive pressure

Negative pressure

Balanced pressure

Ventilation system design considerations

A worked ventilation example

## 112 Glossary

## Authors and contributors

### Project manager:

- ✦ Eion Scott, NZGBC - Senior Manager Residential

### Project director:

- ✦ Sam Archer, NZGBC - Director, Market Transformation

### NZGBC contributors:

- ✦ Matthew Cutler-Welsh - Business Development Manager Residential
- ✦ Damiloju Adeyina - Technical Manager, Residential

### Lead author:

- ✦ Joseph Lyth, Respond Architects - Associate Architect, Certified Passive House Designer, Homestar v5 Assessor and Trainer

### Co-author:

- ✦ Arthur Lee, Respond Architects - Architectural Designer & Certified Passive House
- ✦ Shana Payne, Respond Architects - Senior Registered Architect & Sustainability Specialist, Homestar v5 Assessor

### Contributor:

- ✦ Linda Lodetti, Prendos - Lead QS, Registered & Chartered QS
- ✦ Grant Anderson, Stiebel Eltron - Business Development Manager

## About this guide

### Acknowledging the input of the following industry experts:

- ✦ Aurecon Danidu Wijekoon
- ✦ BRANZ Mark Jones, Stephen McNeil, Jarred Butler, Casimir MacGregor, Ian Cox-Smith
- ✦ Ecoinsite Matt Wilson
- ✦ Hallmark Homes Mike Bonne
- ✦ Hutt City Council Greg Street
- ✦ Jasmax Alan Hayward
- ✦ Kainga Ora Lauren Denny, Andree Lalonde, Nikki Buckett
- ✦ MBIE Richard Almand, Elrond Burrell, Peter Le Quesne, Christian Hoerning
- ✦ ReVolve Jo Woods
- ✦ Simx Storm Harpham
- ✦ Willis Bond Megan Lockwood and Emma Robertson

### Disclaimers

This design guide was commissioned by the New Zealand Green Building Council (NZGBC) and compiled by Respond Architects. It contains general information about designing healthier homes in New Zealand and, specifically how to achieve this by utilising the Homestar® rating tool. NZGBC has used best efforts to ensure all the information contained in this guide is accurate and informative, it is intended as guidance only. NZGBC makes no warranty of any kind, express or implied, about the information set out in it and will not be liable in the event of incidental or consequential damage.

This includes all diagrams (which are **not intended to be sufficient for consenting purposes**) and case studies. If professional advice or other expert assistance is required, you should obtain the services of relevant and competent professionals. They will be responsible for developing design documentation to suit the specific criteria and requirements for each project. Of course, any construction project must comply with the New Zealand Building Code.

Other than if specifically stated, NZGBC does not endorse any company, brand or product.

### Copyright

NZGBC reserves all rights in this guide including copyright and acknowledges that Respond Architects claims copyright in the case study home design drawings set on pages 18 though 45. No part of this guide may be reproduced without permission.

Issue 01

June 2024



Te Kāhui  
Whaihanga  
New Zealand  
Institute of  
Architects



RESPOND — ARCHITECTS



## Homestar certification

### The importance of meeting standards

Every year thousands of new New Zealand homes use Homestar to help deliver healthier, more efficient, lower-carbon homes.

It's widely acknowledged that the Building Code is woefully inadequate, meaning hundreds of thousands of New Zealand homes do not meet basic standards for health, warmth, ventilation, and operating efficiency for our climate.

A warm, dry, healthy home is a basic human right. This is why the New Zealand Building Council offers Homestar – a certification standard that allows designers, architects, and builders across the residential sector to look ahead to build better futures for our whānau to live, work and play.

Homestar rates on a scale of 6 to 10 stars so that homeowners and professionals can better understand where their home or design fits and steps they can take to improve to a better, healthier standard.

### Help slash emissions

The average new New Zealand home produces more than five times too much pollution for our planet to avoid catastrophic climate change. Homestar promotes and incentivises the use of more sustainable materials, less waste, and supports projects to embed more sustainable design and construction practices.

### Make cold, damp homes a thing of the past

Everyone deserves to live in a warm, dry, comfortable home that doesn't cost the earth to run. Unfortunately, the majority of New Zealand homes fail to deliver the homes we deserve. Homestar sets a higher standard for vital things like insulation, heating, and ventilation, to help keep you and your whānau happy and healthy.

### Use less water and energy

Homestar promotes and incentivises homes that are designed and built in way that reduce emissions and keep your operating costs down. From basic steps such as installing LED lighting and efficient water heating, to major decisions such as installing heat-recovery mechanical ventilation systems or solar. Homestar awards and recognises efforts to keep energy and water use to a minimum.

### Continuing to raise the bar

Since launching Homestar in 2010, we have committed to responding to changes in the sector – from improvements in design technique and understanding of New Zealand's changing environmental and climatic conditions, to new products, materials and technologies.

The latest version of Homestar is version 5, bringing updates to:

- ✦ a new operational energy and carbon modelling tool with targets aligned to MBIE's Building for Climate Change framework
- ✦ updated requirements to ensure a healthy, comfortable indoor environment and,
- ✦ for the first time also accounting for embodied carbon.

Achieving a minimum 6 Homestar rating under version 5 is a significant statement of industry leadership for those choosing to be ahead of the building code.

### Certification you can trust

Certification is an independent way to verify the environmental and social outcomes of a project, building or project portfolio. Used across thousands of projects each year, only projects that the NZGBC has certified can claim to have achieved a Homestar, HomeFit, Green Star, or NABERSNZ rating. The Financial Markets Authority, Commerce Commission and Advertising Standards Authority are subjecting green claims to increasing scrutiny. Projects that claim to meet the requirements of NZGBC rating schemes but are not certified are potentially in breach of trademark rules and may be accused of 'greenwash'.

**Homestar has been developed to take into consideration the environmental building standards required regionally, by New Zealand's unique climatic conditions. It allows for specialist assessment by industry professionals that may result in the issue of a formal Homestar certified rating.**



# Introduction





# Introduction

This guide provides an overview of the concepts of building performance introduced in Homestar version 5. It introduces four building case studies of real projects on real sites, examining the issues and a set of solutions to achieve the thermal and carbon performance standards for 6 Homestar and 8 Homestar ratings in three different climate zones – Auckland, Wellington and Christchurch.

The case studies provide an example of how to achieve each level for projects in the respective climate and site. Other combinations may also be possible. The guide refers to best practice methodologies and details wherever possible.

The concepts within each chapter will impact a number of different Homestar credit areas, as highlighted by the 'credit stamp' on the cover of each section. It's important that buildings must be considered holistically, with all elements working together to achieve healthy, energy efficient homes that are good for people, and for the planet.

Note that other Homestar credits such as water, waste, services and site are not included in this guide. Please see the Homestar v5 Technical Manual for more information on these.

## How to use this guide

This guide is intended as a 'how to' guide for designers and professionals, to walk you through the Homestar process and provide options and routes to achieve various Homestar levels, and higher performance, healthier buildings.

It is primarily for residential buildings, whether standalone, multi-unit, terraced, and for any height. While the design principles are applicable to all building typologies, it should be noted that buildings taller than three storeys are likely to require specific design, because of the complexity of engineering requirements for such buildings.

This guide should be used alongside the suite of Homestar documents and calculators, outlined below.

## Resources

- High Performance Construction Details Handbook, Passive House Institute.
- Homestar v5 Technical Manual
- Homestar Embodied Carbon Calculator (HECC)
- Energy and Carbon Calculator for Homes (ECCHO)

## Resources

[High Performance Construction Details Handbook, Passive House Institute.](#)  
[Homestar v5 Technical Manual](#)

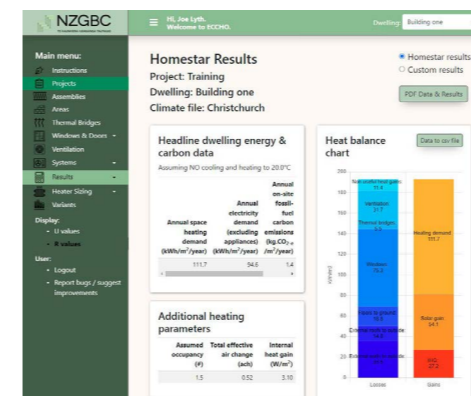
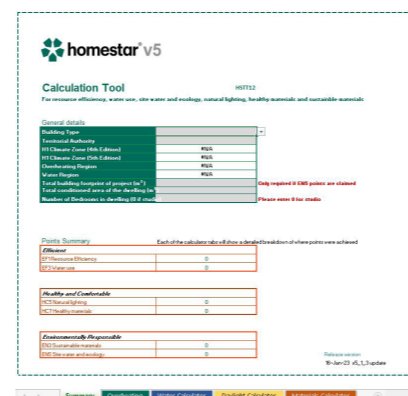
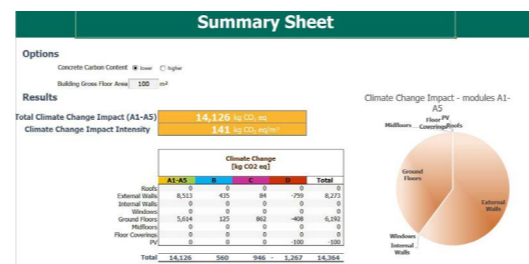
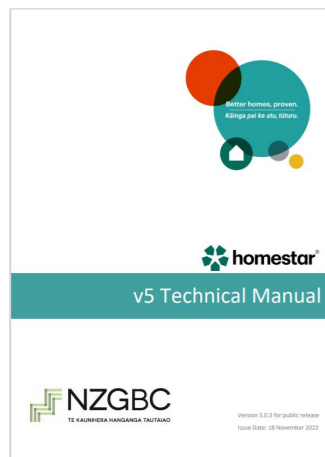

## Calculate

- [HECC](#)
- [Homestar Calculation Tool](#)
- [ECCHO](#)

## Homestar credit stamp



## EF1: Resource Efficiency



Homestar v5 Project Scorecards - Coversheet

## Submit

- [Scorecard](#)

## What?

- [Technical Manual](#)

## How?

- [Design Guide](#)



## High performance design workflow vs traditional workflow

To produce a successful Homestar project, the workflow differs from the traditional process. There is a lot more decision making earlier in the process which will dictate the performance of the building.

Making these decisions earlier mean there is far less uncertainty during the construction phase, and the result is a much more durable, lower energy building.

■ Typical construction workflow
 ■ Performance workflow

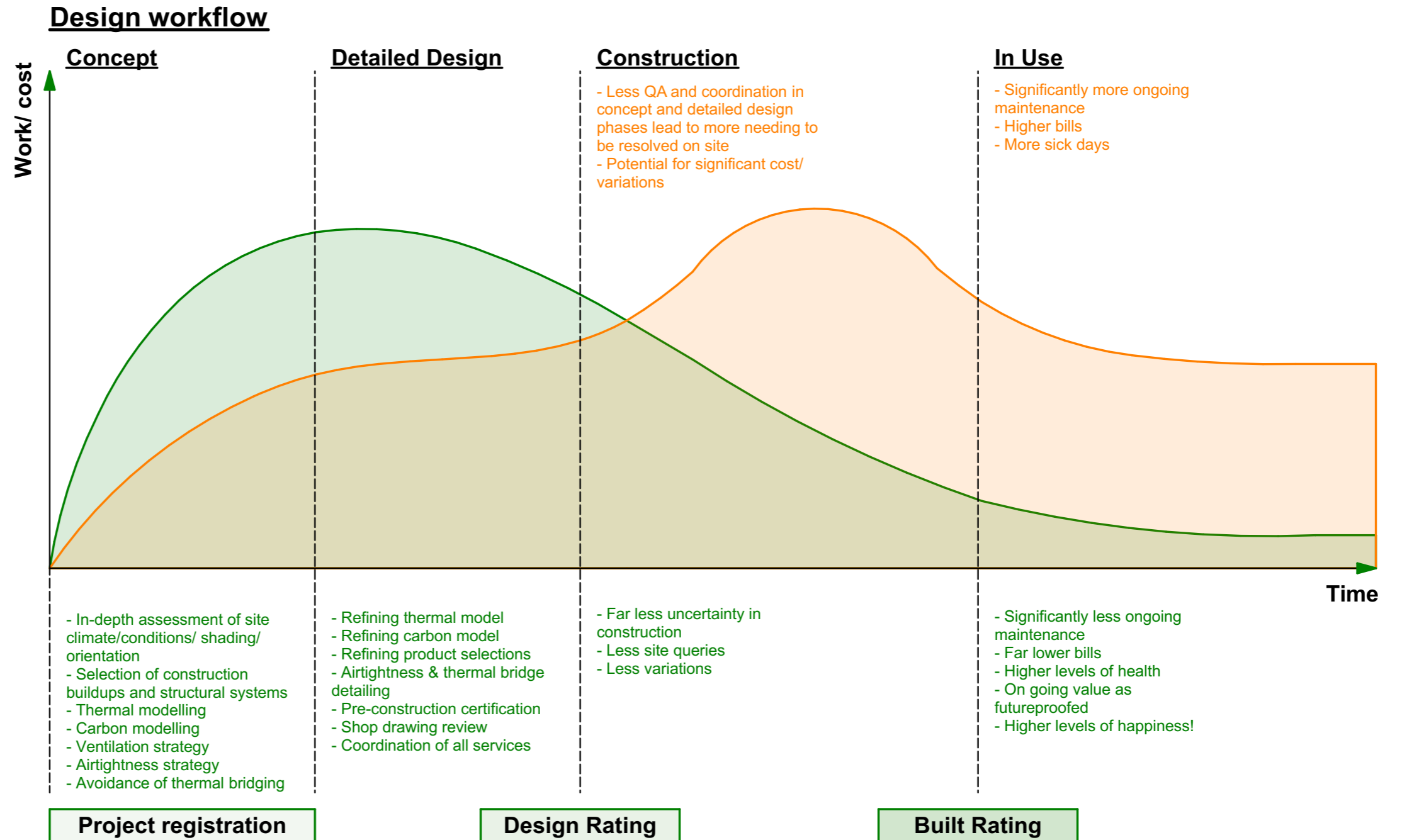

## An introduction to energy modelling

### What is energy modelling?

Energy modelling is a process that simulates how a building will consume energy based on its design, materials and systems.

At its simplest, user inputs site location; exterior heat loss areas; thermal performance of the materials and construction build-ups that make up the building envelope; factors, such as heating, cooling, lighting, and ventilation systems; as well as the building's orientation and occupancy patterns. The software model will then give results to show energy demand for heating and cooling, overheating potential, humidity, and a range of other factors which can then be used to refine the building design and specification.

### Why energy modelling for buildings?

The goal is to assess the energy performance of the building and identify opportunities for improvement. Energy modelling can be used to compare the performance of different building designs, evaluate the impact of various energy-saving measures, and optimise building systems to reduce energy consumption and greenhouse gas emissions.

### How does energy modelling add value to design and building?

Energy models enable designers to understand how well the building as designed is expected to perform on the site where it is to be built, and refine the design to perform better. Without this, there is no way to understand the expected amount of energy it will take to heat or cool, which may lead to uncomfortable, unhealthy, expensive-to-run homes, locking in poor performance for generations.

Energy modelling during the design process informs the designer what the elements of the building need to be to achieve defined levels of performance - not too little or too much insulation, specific glass types for different elevations, sufficiently sized ventilation, heating and cooling systems.

Working through this process ensures the building is neither over, nor under specified, so the budget is used where it is needed rather than being wasted on incorrect specifications - too much insulation, expensive glazing, oversized heating or cooling systems, etc.

### When is the best time to energy model?

This can depend on a designer's work flow. Best practice is to produce an energy model as soon as the initial building form is decided on (see [Design workflow graph](#)). This then enables all design

decisions to include feedback from the energy model - orientation, joinery size, requirements for overhangs, shading. It is most valuable when used to inform the design, rather than as a last step.

### Who can do energy models?

Anyone can learn how to energy model. An experienced professional will normally be able to provide a more accurate and informed model, and outcomes.

### Where do I start if I know nothing about energy modelling?

The Homestar Designer Course from NZGBC is an ideal place to start to learn energy modelling. The course runs through how to use ECCHO, HECC and the other calculators and tools.

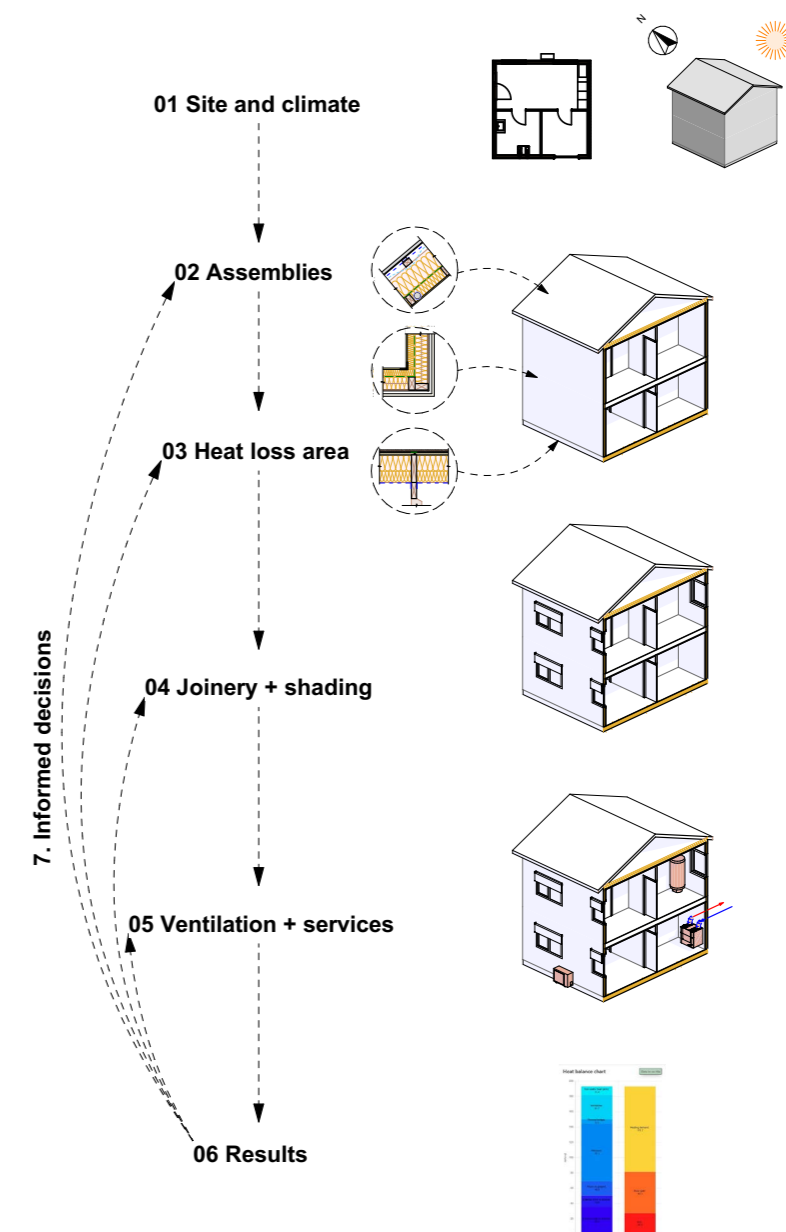



# Homestar v5 design workflow

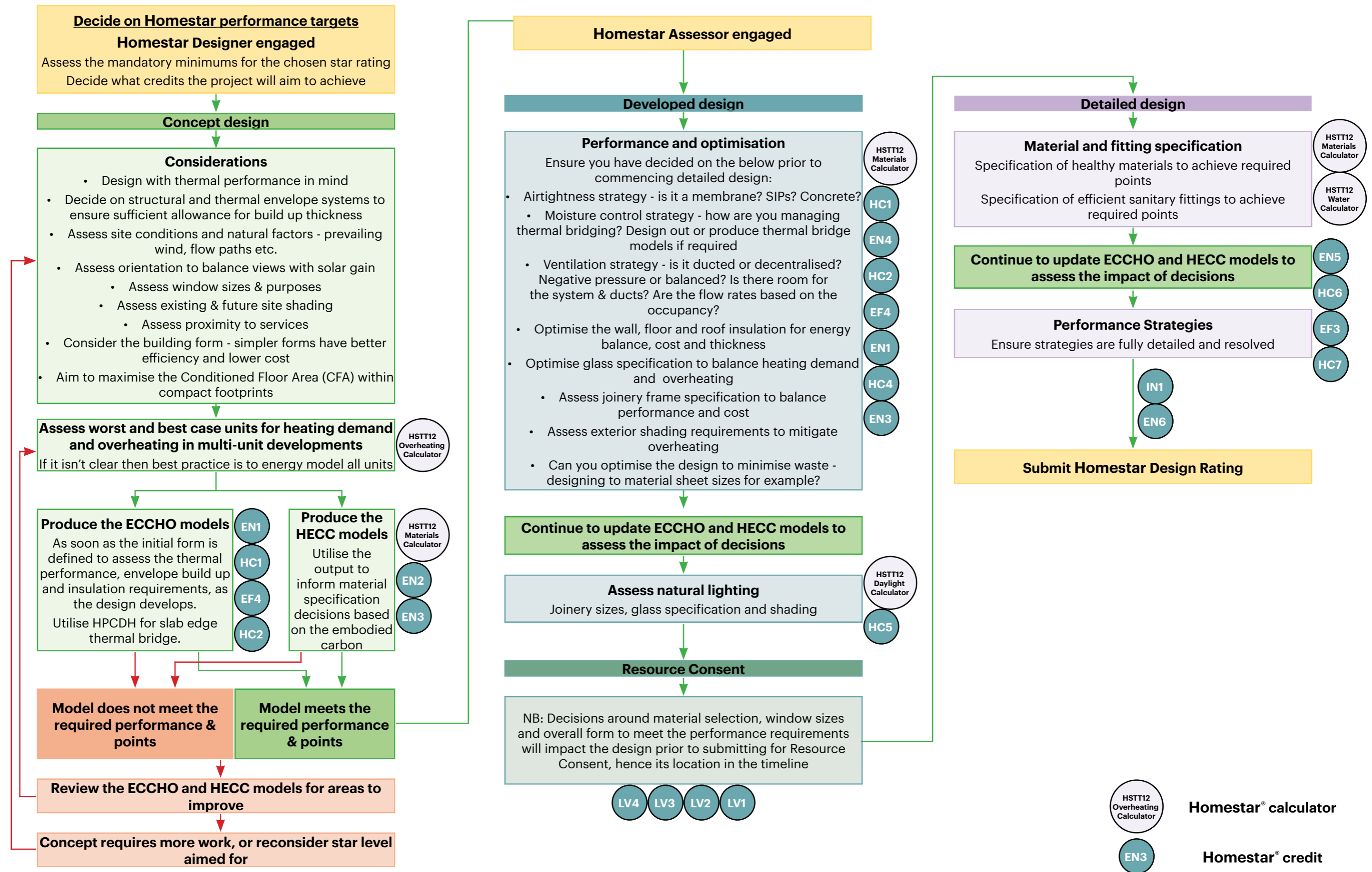

## ECCHO

The Homestar energy analysis tool, ECCHO (Energy and Carbon Calculator for Homes), allows users to calculate the heating and cooling demand, energy consumption, overheating risk, and carbon emissions of a home. It is used to provide evidence for several credits:

EF4: Energy Use

HC1: Winter Comfort

HC2: Summer Comfort

EN1: Renewable Energy

It is a mandatory minimum for all projects aiming for a star rating to be energy modelled, whether in ECCHO or another software, to assess the building performance, as set out in Appendix A of the Homestar® Technical Manual.

There is further information on ECCHO in the [Homestar Technical Manual - Appendix B](#).

ECCHO energy model results page

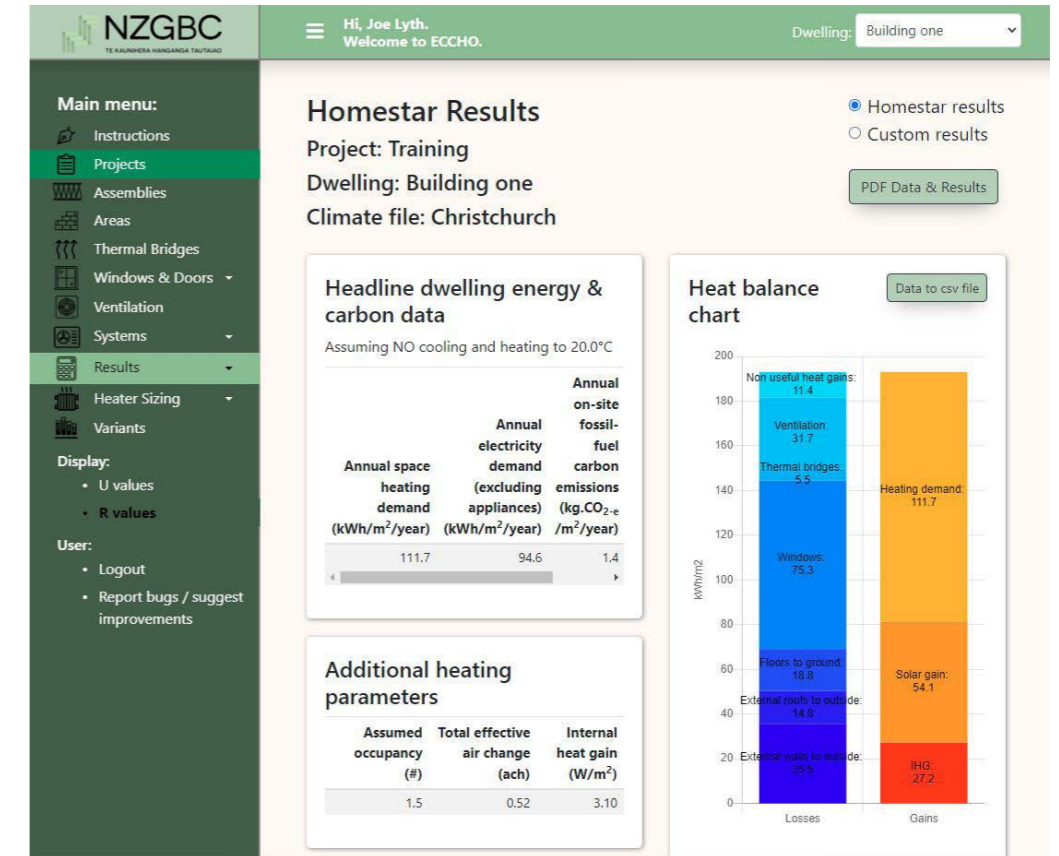

## HECC

Homestar v5 includes a new credit (EN2: Embodied Carbon) that rewards projects taking steps to reduce greenhouse gas emissions associated with the products and materials used to construct a home. The [embodied carbon](#) content of a project is an important metric that should be considered when delivering the homes needed for a sustainable future while meeting our obligations to de-carbonise the building industry.

While other (third-party) tools may also be used to comply with the EN2 credit, BRANZ (the Building Research Association) has developed the Homestar Embodied Carbon Calculator (HECC) for NZGBC ([download here](#)) as an easy-to-use-tool for estimating the embodied carbon content of a typical home.

It is a mandatory minimum to produce a HECC model for all projects seeking a star rating. More information on calculating embodied carbon can be found in the [Carbon chapter](#).

HECC model results page

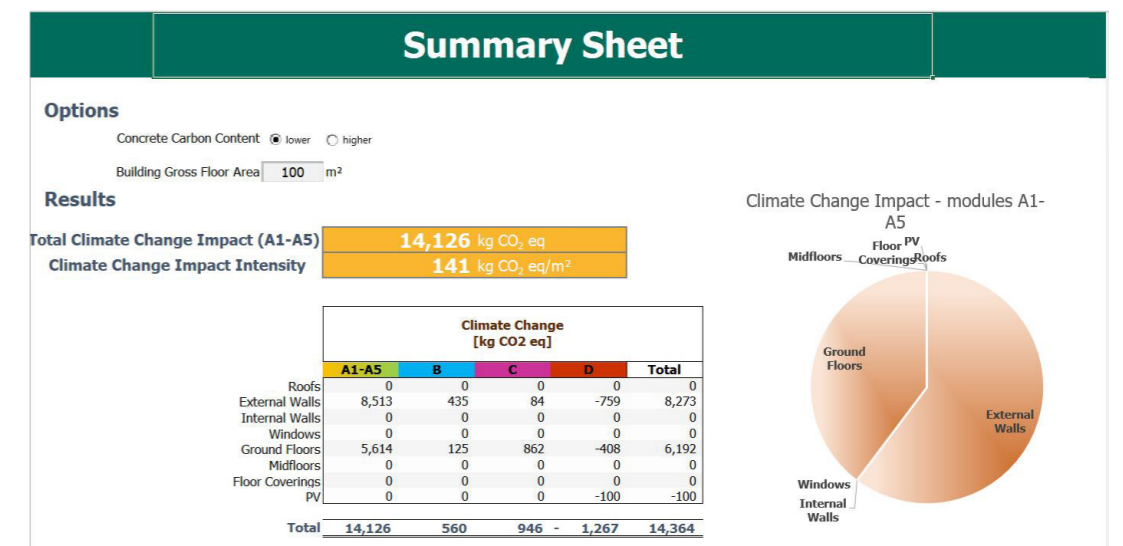



## Using the results

One of the most useful elements in ECCHO to impact your design decisions is the heat balance chart which we can see on the results page once we've completed an assessment.

This simple bar chart enables you to see where the heat losses and heat gains are occurring in the building during the 'heating period' - i.e. the times during the year that heat energy will be required to keep the temperature up, based on the climate data.

The columns will always be the same height, as to keep temperature at a constant level the heat losses and gains must be the same. In the diagram on the right you can see the total energy required to keep the temperature at 20 degrees celsius is  $19.5 \text{ kWh/m}^2/\text{year}$  (hereafter abbreviated to  $\text{kWh/m}^2$ ).

To keep the building at a constant temperature it's important to reduce the heat loss as much as possible and reduce the amount of heat energy required to replace the losses.

The blue column on the left shows the amount of heat loss:

- ▣ **Walls, floors, roofs and windows** - transmission heat loss through the exterior envelope areas
- ▣ **Ventilation** - this includes loss through open windows for passive ventilation, air leaks in the building envelope, and heat loss through the efficiency of the ventilation systems.
- ▣ **Non-useful heat gains** - a correction factor that covers excess heat energy that can't be utilised during the 'heating period' - too much solar gain for example.

- ▣ **Thermal Bridges** - transmission heat loss through elements where the insulation layer is interrupted

Looking at this we can see which elements are performing the worst, and so which areas we may need to consider - if most of the heat is being lost through the walls then we may need to increase the wall insulation for example. This will then reduce heat loss through this element, and reduce the height of the chart, as the total energy required will be less.

The column on the right shows heat gain:

- ▣ **IHG (internal heat gain)** - the energy produced from appliances and lighting as well as from the occupants themselves.
- ▣ **Solar gain** - the amount of free heat energy from the sun. The more of this, the less additional energy is needed to add and balance against the levels of overheating.
- ▣ **Excess thermal bridges** - a correction factor for any negative thermal bridges, e.g. where heat loss through a corner is less than assumed in the external envelope areas calculation.
- ▣ **Heating demand** - the excess energy we need to add to keep the steady temperature, i.e. the energy from our heat pumps, radiators and woodburners. This is the section we need to reduce as much as we can.

Depending on the project, performance and climate, the correction factors for non-useful heat gains, thermal bridges and excess thermal bridges may not be relevant so will not show in the chart.

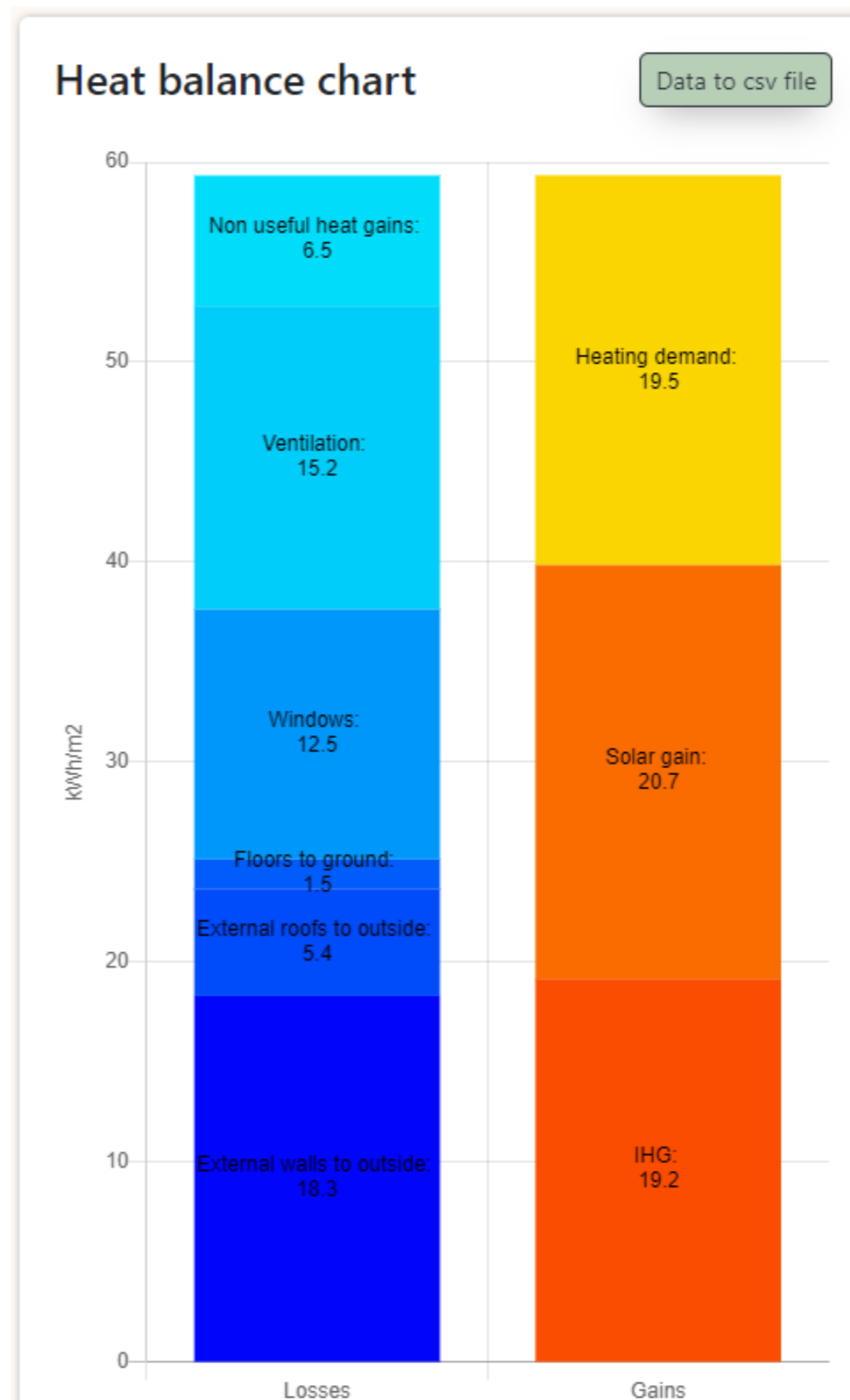

## A worked example

Once the first pass of ECCHO modelling is completed, look to the results page, and the heat balance chart, to see where the design may need to be further developed.

Looking at the first graph on the right, the majority of losses are through windows (75.35kWh/m<sup>2</sup>), walls (35.48kWh/m<sup>2</sup>) and ventilation losses (31.69kWh/m<sup>2</sup>), with a total heating demand of 111.7kWh/m<sup>2</sup>.

To manage variations to the envelope, look at the specification of windows and ventilation systems, and the airtightness of the building envelope. Potential variations to consider:

- ✚ Change glass to one with a better U<sub>g</sub>-value and frames to a better uPVC frame
- ✚ Change from extract only ventilation to a balanced heat recovery ventilation system
- ✚ Change the airtightness from 5 ach (air changes per hour) to 1 ach allowing for a considered airtightness strategy (but realise this will need to be confirmed with a blower door test for Homestar certification).

Without changing the shape or size of the building at all, these changes have enabled the reduction in heating demand from 111.7kWh/m<sup>2</sup> to 61.02kWh/m<sup>2</sup> - a 45% decrease! The change to the glass has also reduced the solar gains due to the g-value of the low-e coating.

To further increase performance look again at the heat balance chart.

The sections on the losses column are more equal, but the walls and windows are still the largest, and there are 5.5kWh/m<sup>2</sup> losses through thermal bridges. Revisit the proposal and:

- ✚ Design out thermal bridges as much as possible
- ✚ Look at the wall insulation specification and increase the thermal performance, or consider an insulated services cavity - this would also likely decrease the CFA though
- ✚ Consider either triple glazing, or look to the window sizes to see if any sizes can be decreased to reduce losses. to reduce the losses. This will also impact the amount of free solar heat on the gains column though, so balance this by looking for glass with a higher g-value to allow more free heat; however also assess the impact of this on overheating!

In this example, the heat balance chart can help us refine the specification of the building to achieve the required performance levels, often with minimal alterations, but it's always a balance, and each decision needs to be weighed - increasing insulation will retain more heat, but may contribute to overheating. Better glass and low-e coatings may lower overheating, but it may also reduce the amount of solar gain, etc.

The energy model is only the start - once you have completed the first pass and checked the energy balance, then you have the information you need to improve the design - so do it early

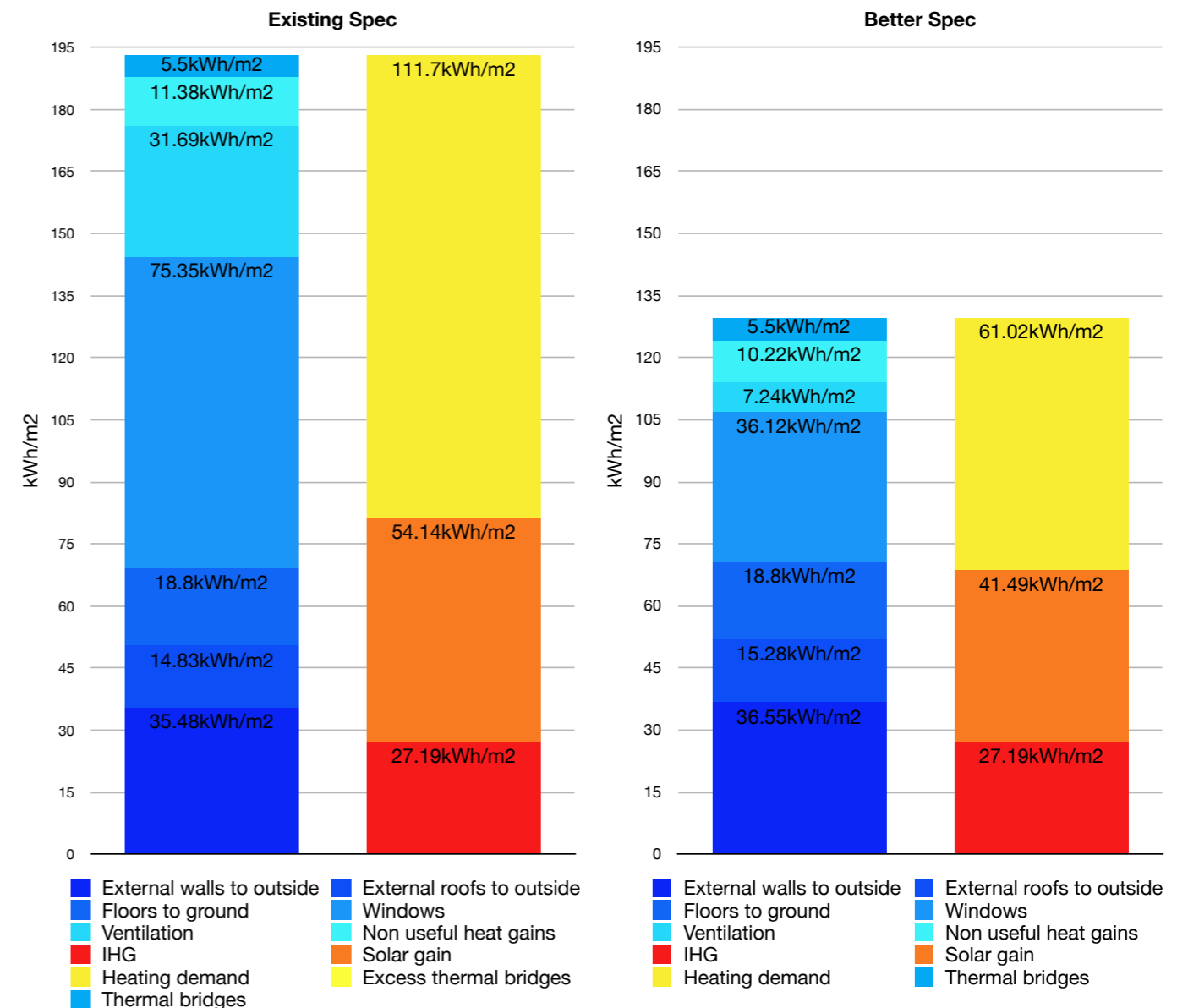

### Initial specification:

Windows - thermally broken aluminium  
 Glass - double low-e glazing, argon, U<sub>g</sub>1.9  
 Ventilation - mechanical extract only ventilation  
 Airtightness - 5 ach

### Proposed Specification:

Windows - uPVC frames  
 Glass - double low-e glazing, krypton, U<sub>g</sub>0.9  
 Ventilation - balanced heat recovery ventilation  
 Airtightness - 1 ach



# Case studies

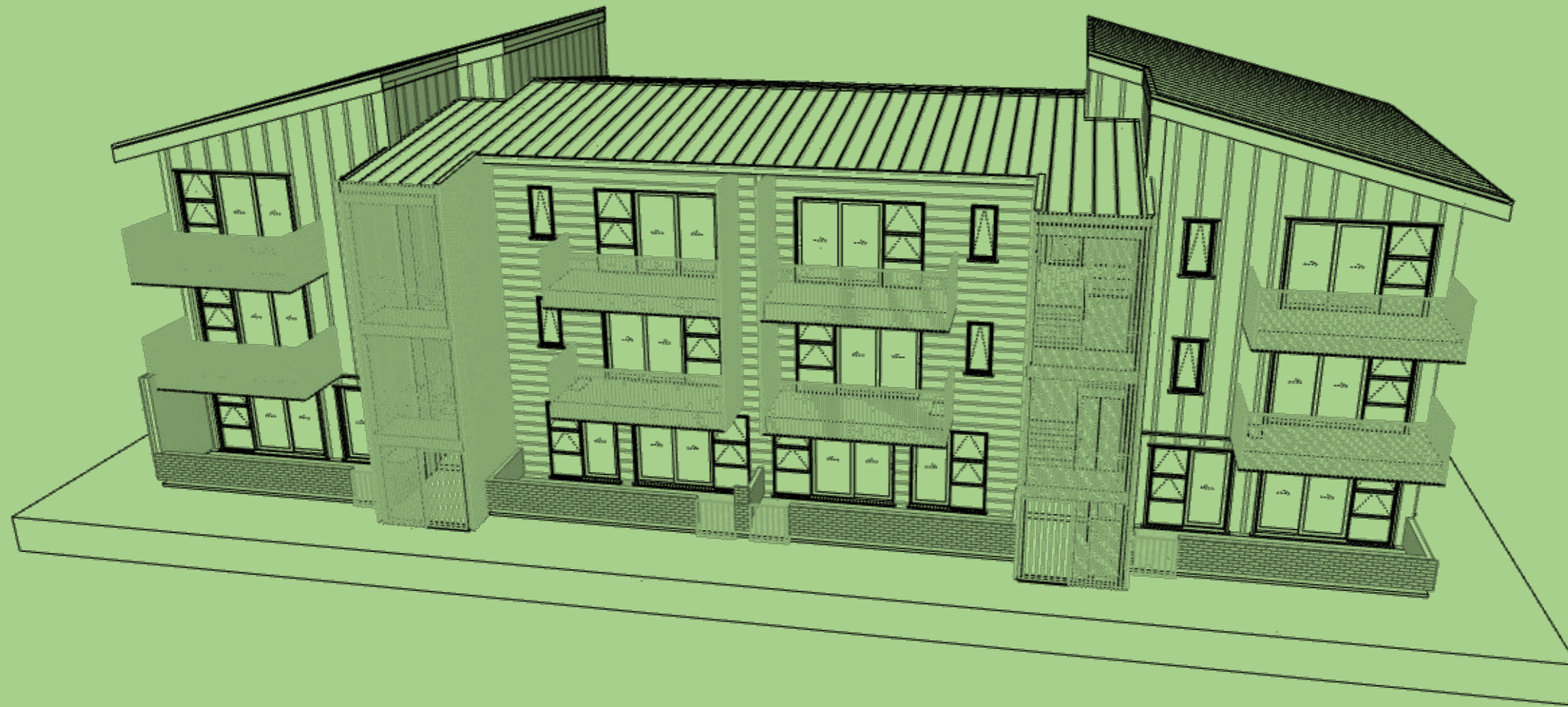

# Case studies

The following drawings are for four case studies of typical building types in New Zealand. Each of them has been thermally modelled in ECCHO (Energy Carbon Calculator for Homes) in three different climate zones to assess what specification will be required to meet both 6 Homestar and 8 Homestar levels of performance in each climate.

The specifications produced show one way of achieving the required performance levels. Every project will need to be individually modelled to achieve the best outcomes for the available budget.

Further build-ups and assemblies are detailed in the [Assemblies](#) chapter.

The case studies have been selected to show real world scenarios and therefore are not necessarily perfectly orientated for optimal performance.

## How to use this section

**Performance considerations** - These show the thought process around the building performance based on the initially specified building fabric, prior to making any decisions on upgrades to the specification.

**Drawings** - 3D views, plans, elevations and sections have been provided for each typology to give an overview of the design.

**Specification table** - This shows the selected specifications to meet 6 Homestar and 8 Homestar in three different climate zones for these specific designs, on these specific sites. These are provided to give an example starting point for similar projects in each climate, however each project will need to be tailored individually.

**Results** - This shows the specific ECCHO results for each typology, climate and star rating for comparison.

**Costing** - This provides high level pricing of each typology, isolating the performance related upgrades and the cost increase from building code minimum for 6 Homestar and 8 Homestar, in the three climate zones.

## What if I want to do better?

These case studies and specifications work for these unique designs, in the specified sites and climates, to show an example of how to achieve certain performance levels. This doesn't mean the same specifications would have the same results for a different building in the same site, or the same building on a different site.

**Energy modelling is a holistic approach to building performance**, and is all about balance. Increasing window performance could call for a decrease in insulation, and achieve similar performance for less cost. The only way to judge this is to model the design, then assess the results and heat balance chart to see where the changes could be made.





## Performance considerations for all case studies

When designing for performance, decisions must be made earlier in the design process than in a traditional work flow. Building fabric, space for ventilation systems, joinery size and shading; all can impact the overall performance and aesthetic of the building, and each has a differing impact.

The following key points are ordered in level of impact on the overall performance, specifically when undertaking the design and energy modelling for the following four case studies:

**1. Design** is the best tool to optimise thermal performance, as upgrading a specification once a design is well resolved can be costly and less effective. All four case studies in this guide have been designed with energy balance in mind, but they have not been oriented to optimise thermal performance. This methodology is chosen to represent an average scenario and inform realistic baseline specification decisions.

**2. Specifications** are about the balance of how all performance related items work together as one system. ECCHO is the critical tool to inform the best balance amongst insulation, thermal bridges, windows, ventilation and airtightness.

**3. Climate** always has a significant impact on the ease/difficulty of achieving the targeted rating. Overall, a warmer climate should make it easier to achieve the heating demand and total electricity demand target than colder climates. However, the overheating target can often trigger additional upgrades on glazing and shading devices in warmer climates.

**4. A 6 Homestar** accommodates a larger portion of “standard practices” such as traditional framing with timber corner and dwangs, window installation flush with cladding, as well as ECCHO default window frame, front door panel and glazing specs. This is due to requiring lower performance levels, which means we can accommodate more heat loss.

**5. A 8 Homestar** requires a larger portion of “best practices” such as 2 stud corners without dwangs, recessed window installation, supplier’s specific window frames, front door panel, and glazing data. This is due to requiring higher performance levels, which means we need to be more specific in our decisions with less margin for error.

**6. Window and glazing** are nearly always the most important contributors to both heating demand and the potential for overheating. Implementing fit for purpose solutions for each individual project is critically important, but is also a relatively easy alteration - changing the frames or glass will have minimal impact on the form or overall design. Using default values in ECCHO is suitable when there is a medium to large margin on both heating demand and overheating. However, obtaining exact window and glazing data from manufacturers is required to represent the real performance. When overheating potential is high, specific selection of low-e glass is required.

**7. Wall insulation** is nearly always the second most influential system on heating demand. Smart framing solutions such as removing dwangs and using two stud corners to optimise the wall framing is an easy and cost-effective solution to improve thermal performance. Other barriers for external wall upgrade can be high. For example, the next level from conventional 140mm framing wall is to add a 45mm insulated service cavity, which triggers additional labour and external bracing.

**8. Roof insulation** normally has a small impact on performance. This is due to the relatively high requirement by the building code H1. Having roof insulation less than R6.6 can sometimes provide a better overall balance. Roof insulation less than R5.2 is generally not encouraged because it is likely to cause both higher heating demand and overheating.

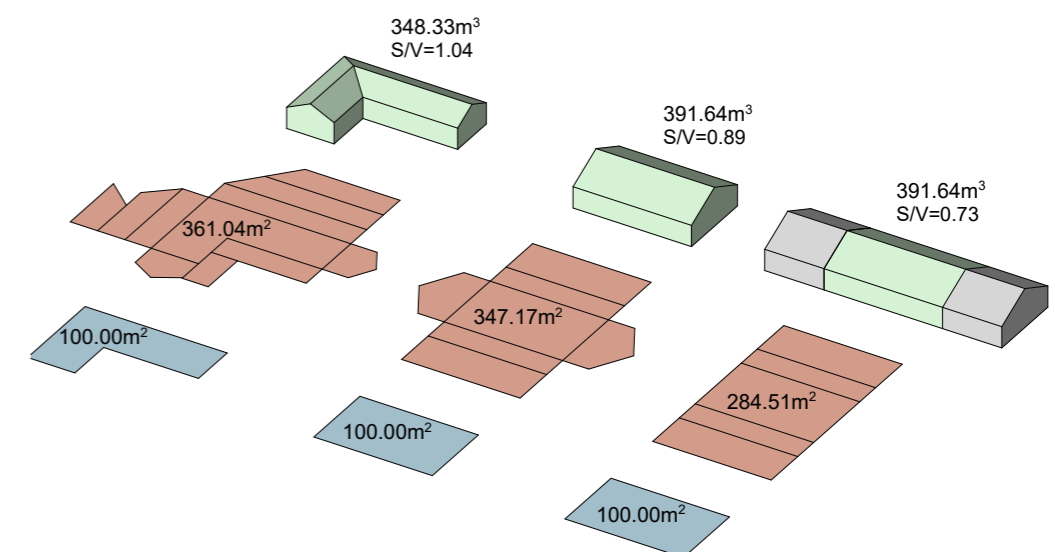

The more complex the form of the building, the harder it is to achieve higher levels of performance as there is more heat loss area compared to the volume or floor area. These three buildings have the same floor area, but adding a bend in the form increases the heat loss area by 4%, and increases the surface to volume ratio (S/V) from 0.89 to 1.04 - a 16.8% increase.

Making the building part of a terrace decreases the surface area, as only the areas not bordering other units count as heat loss area, so achieving higher performance is even easier.

## Performance considerations for all case studies (cont.)

**9. Suspended floor insulation** normally has a small impact on performance. Utilise the maximum depth of the floor joists and fill with insulation, include a wind-washing membrane layer to the underside, and ensure ground cover is specified - a mandatory minimum.

**10. Slab insulation** normally has a small impact on performance if it is fully insulated to the edges and underside. In waffle pod slab systems, such as waffle slab with slab edge insulation, the pods do not add much to the thermal performance as the concrete ribs bypass this layer. They would also likely fail the mandatory minimum fR<sub>si</sub> requirement. For this reason, only fully insulated slabs are encouraged and assessed in this design guide.

**11.** The effectiveness of **ventilation systems** vary a lot in different climate zones. In warmer climates like Auckland, the percentage of heat loss through ventilation and air infiltration is significantly less than in colder climate zones like Christchurch. Without MVHR, the ventilation heat loss in Christchurch can be as much as all external walls combined.

**12. Airtightness** is for energy and moisture control. Where airtightness is assumed to be below 5 air changes per hour in ECCHO, it needs to be proven with a pressure test.

**13. Thermal bridges** normally have a small impact on performance as long as they meet the mandatory minimum fR<sub>si</sub> requirement. The main concern here is avoiding condensation and mould risk.

**14. Heating and hot water systems** have no impact on heating demand but have significant impact on total electricity demand. The project may meet the heating demand target but fail the total electricity demand unless extensive use of heat pumps is specified.

**15. Natural ventilation** is an effective way to reduce summer overheating. However, a conservative assumption must be used, therefore it is not sufficient to provide natural ventilation. Natural ventilation relies on weather and occupant behaviour, neither of which can be guaranteed, and during winter contributes to significant heat loss.

**16. Temporary and/or fixed shading devices** are required to meet the overheating target in most cases. The solution is often very project specific, ranging from internal window treatment, external blind / shutter, custom privacy / shading screen, window surround, to louvre / pergola systems. The effect must be assessed in ECCHO with the best possible parameters. Sometimes, it could require a reasonable guesstimate based on the designer's judgement.

## Mandatory minimums

Each Homestar star band has a set of mandatory minimums that must be met. These dictate the performance levels we are aiming to achieve in each climate zone with each typology.

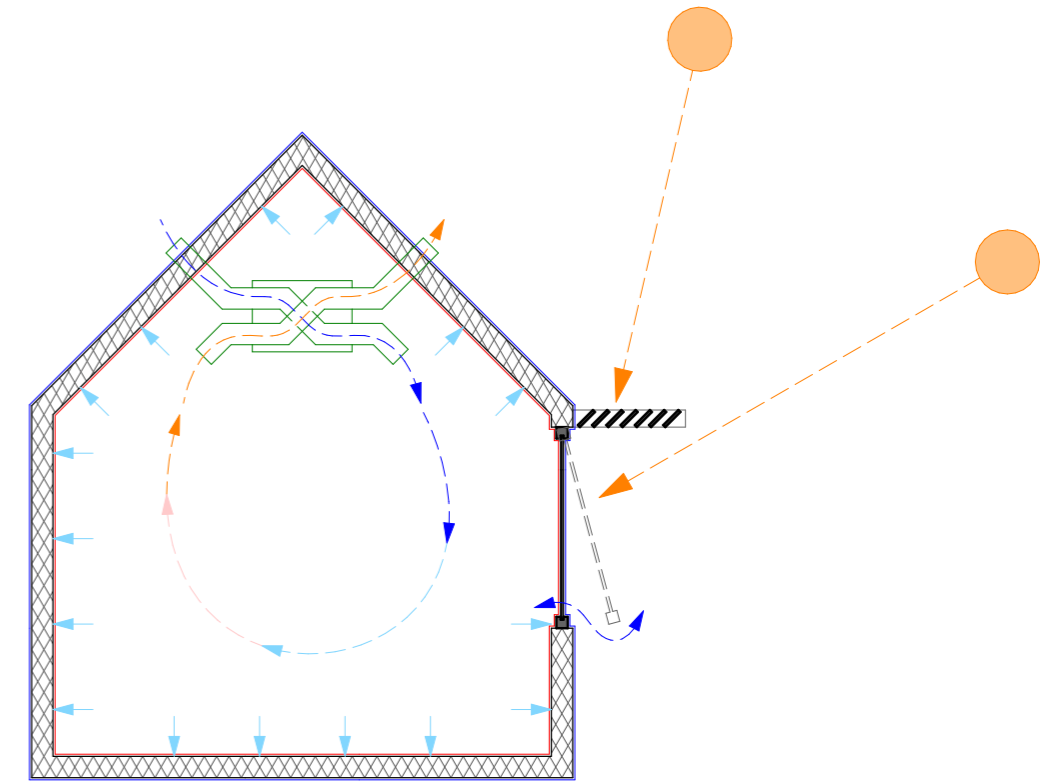

A building must be considered holistically, as each decision will impact other areas of the building design and performance, and they all work together, as a system.

The following table shows the minimums applicable to all climate zones within each star band, and those that differentiate based on climate zone:



## Mandatory Minimums

		6 Homestar			8 Homestar		
	Credit	Auckland 1	Wellington 3	Christchurch 5	Auckland 1	Wellington 3	Christchurch 5
	HC1	The main living area must have an adequately sized fixed heating system.					
	HC3	All doors between conditioned space and garage must be fully sealed.					
	HC3	All combustion appliances must be room sealed.					
	HC4	Windows must be thermally broken.					
	HC4				All junctions between external walls, floors and roofs must be demonstrated to meet the minimum fRsi factors for the respective climate zone.		
	HC4	Ground vapour barrier must be installed to the ground below all suspended floors.					
Maximum water consumption	EF3	145l/p			120l/p		
Maximum delivered energy (excluding appliances)	EF4	52	65	78	31	35	40
Winter Comfort - space heating demand	HC1	40	60	80	20	24	28
Onsite greenhouse gas emissions	EF4	4kg.CO <sub>2</sub> -e/m <sup>2</sup>			2kg.CO <sub>2</sub> -e/m <sup>2</sup>		
Overheating	HC2	7% of the year over 25°C			5% of the year over 25°C		
Ventilation	HC3	Continuous extract			Commissioned continuous extract ventilation meeting the requirements OR balanced mechanical ventilation must be installed as a minimum.		
Pressure test	HC4	N/A			Maximum pressure test result at 50 Pa is 3 m <sup>3</sup> /m <sup>2</sup> /hr.		
Air & Vapour barriers	HC4	N/A			Identified		
Carbon	EN2	Projects must carry out a full lifecycle assessment, modules A-D of EN 15978.			Projects must carry out a full lifecycle assessment, modules A-D of EN 15978.		



## Case study 1

### Single storey standalone house - low glazing

Conditioned floor area:	93m <sup>2</sup>
Thermal mass type:	Timber floor on piles
Window to wall ratio:	16%
<u>Form factor:</u>	3.9

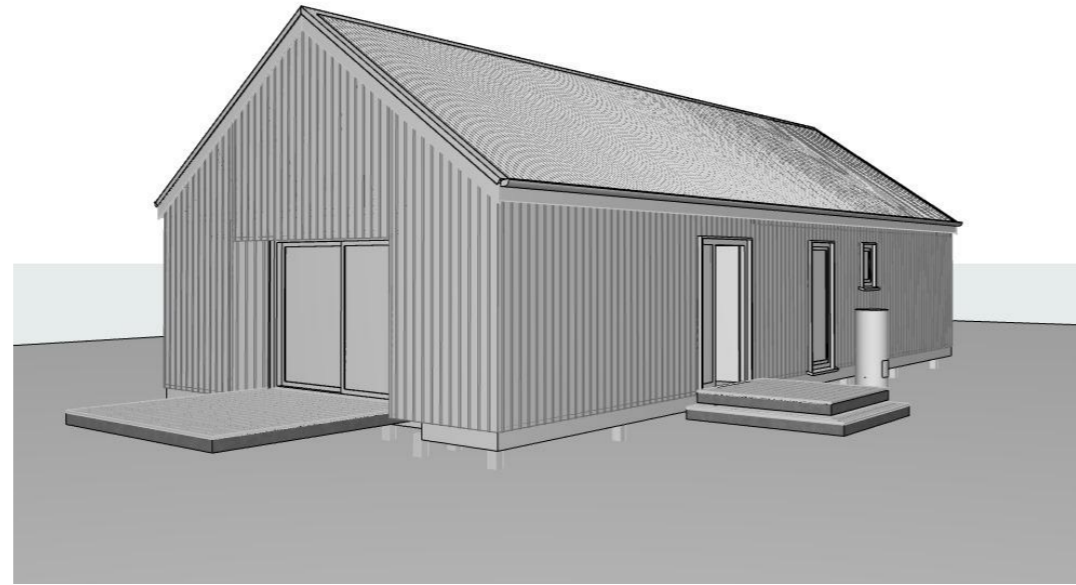

EXTERIOR 1

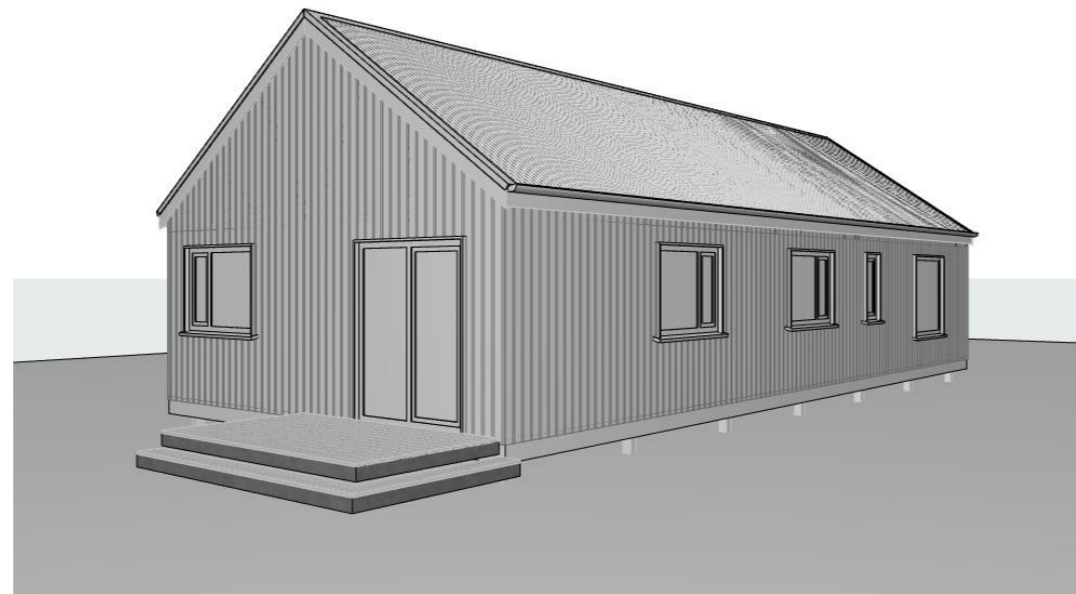

EXTERIOR 2

Case study 1 is a single storey, stand alone home with three bedrooms, a bathroom and WC. It is on a suspended timber floor and has a combination of a flat and raking ceiling. The design has a simple form and compact footprint which makes achieving higher performance levels more straight forward. The more complex the form, the more external heat loss area, the harder it will be to achieve performance.

#### Performance considerations for case study 1

- ✚ Light timber frame construction generally means the entire house is easy to insulate and is easy to add more insulation to both floor and roof when required.
- ✚ Light timber frame construction has little to no thermal bridging to be concerned about when there is no steel or concrete involved. In most cases, this automatically fulfils the fRsi thermal bridge and mould assessment requirement.
- ✚ Low glazing to wall ratio makes the overheating target easy to achieve, which avoids additional effort and cost to design and build specific shading devices.
- ✚ Low glazing to wall ratio can limit heat loss but it is not necessarily positive for the overall energy balance as it can limit solar gain, too. Careful design and window placement are still required to achieve the right balance.



Thermal Envelope

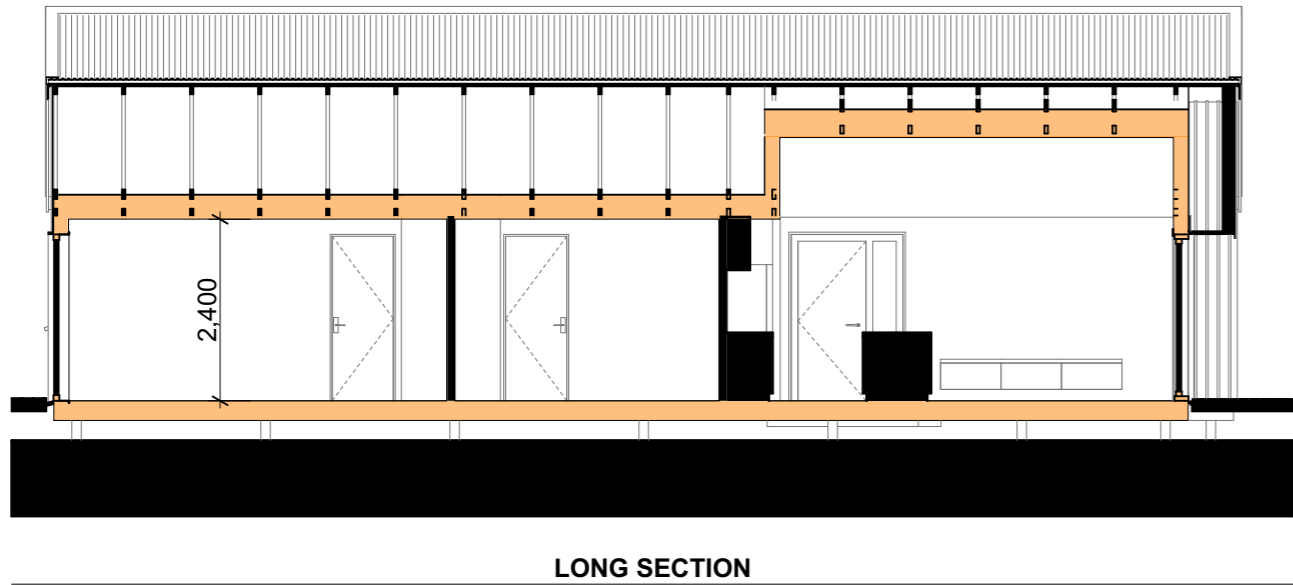

LONG SECTION

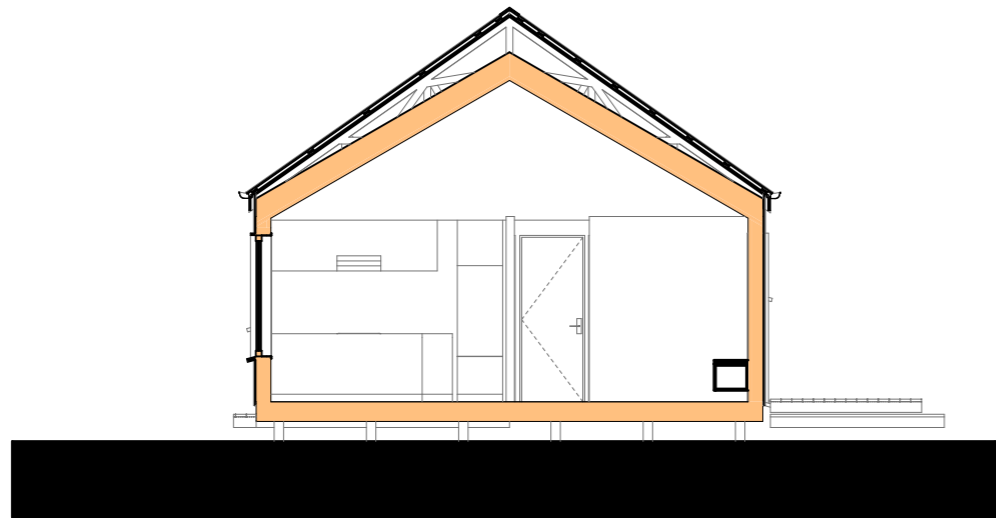

SHORT SECTION 01

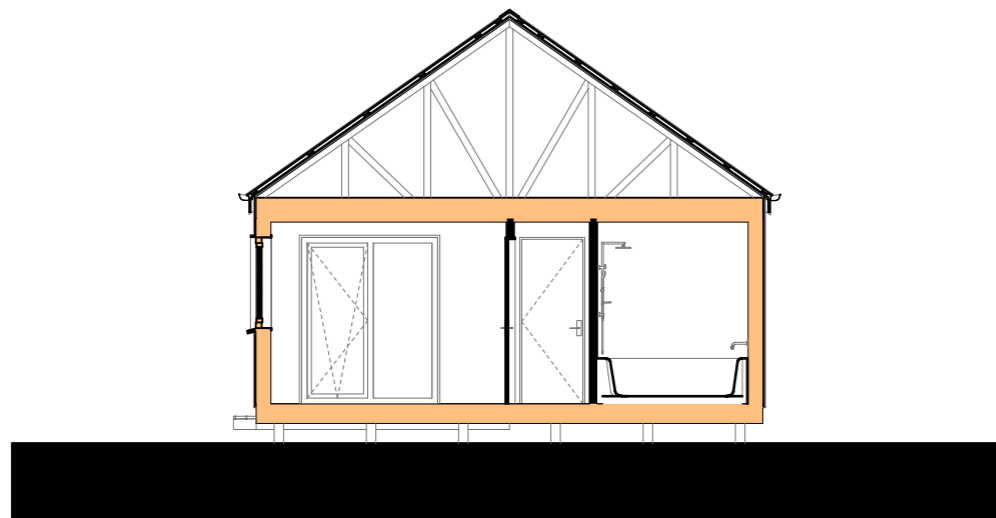

SHORT SECTION 02

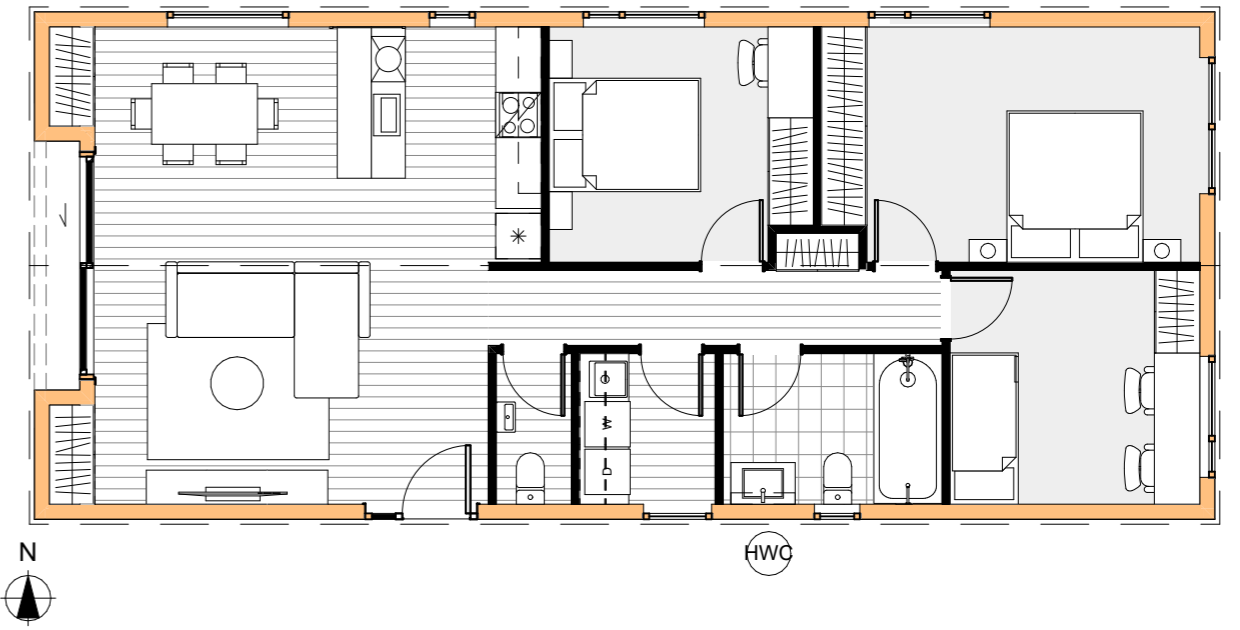

GROUND FLOOR

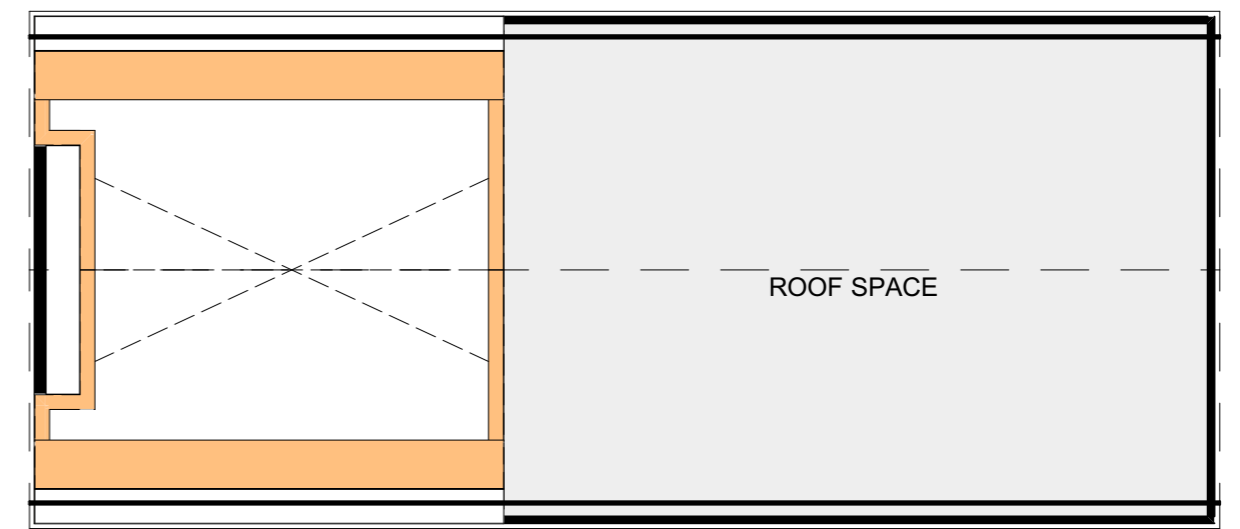

ROOF SPACE



EAST ELEVATION PROPOSED

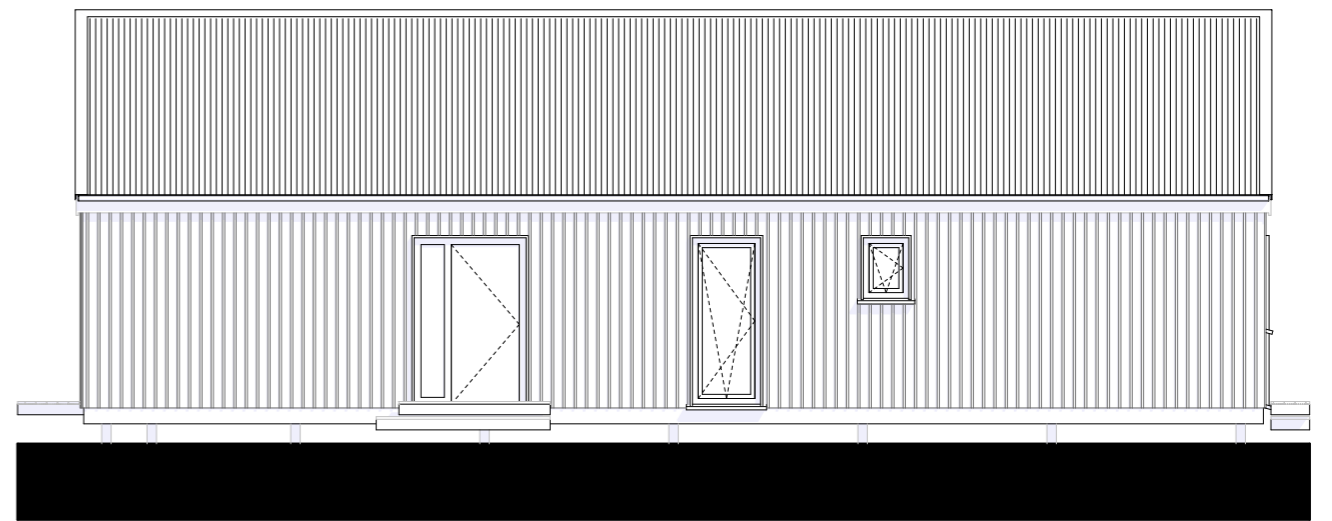

SOUTH ELEVATION PROPOSED

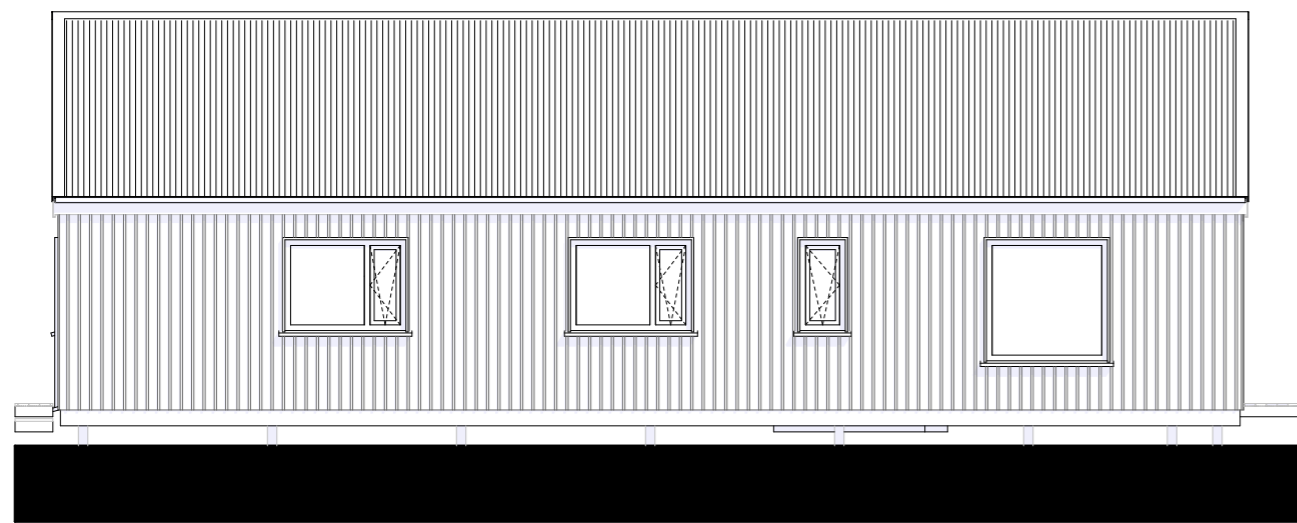

NORTH ELEVATION PROPOSED



WEST ELEVATION PROPOSED



## Case study 1 - Specification

The below table shows the different specification upgrades needed from Building Code minimum, ordered by Homestar level and climate severity. This demonstrates how some specifications are suitable for a range of climates.

For thermal bridges the table refers to the High Performance Construction Details Handbook (HPCDH) which is explained in greater detail in the [Moisture Control chapter](#).

	AKL HS6	WLG HS6	CHCH HS6	AKL HS8	WLG HS8	CHCH HS8
Floor	FLOOR: Suspended Floor with 190 insulation			FLOOR: Suspended Floor with 240 insulation		
Wall	WALL: 90 framing (30% timber content)	WALL: 140 framing (30% timber content)		WALL: 90 framing + 45 service cavity with airtight membrane (30% timber content)	WALL: 140 framing + 45 service cavity with airtight membrane optimised (15% timber content)	
Roof	ROOF: R6.6 Rafter/Truss roof			ROOF: R7.7 Rafter/Truss roof with insulated ceiling cavity		
Thermal Bridges	HPCD 45 - External Wall to suspended timber Floor Slab - 90mm stud wall current practice			HPCD 46 - External Wall to suspended timber Floor Slab - 140/45 stud wall fully insulated timber floor HPCD 57 - Truss Ceiling Roof Eaves - Truss roof raised heel to maintain insulation thickness HPCD 8 - External Wall - External corner 140/45 stud wall no extra timber		
Window frame	ECCHO Aluminium thermally broken			ECCHO generic PVC frame (recessed)		Optimal PVC frame (supplier specific data, recessed)
Glass	ECCHO Double Low-e Arg Best (Ug=1.30)			ECCHO Double Low-e Arg Exceptional (Ug=1.10)	ECCHO Double Low-e Arg Best (Ug=1.30)	Triple Low-e Arg Exceptional (supplier specific data, Ug=0.60, g=0.49)
Door panel	ECCHO Standard door			Insulated front door panel (supplier specific data)		
Shading objects	Only internal blinds on all windows except front door					
Ventilation	Continuous extract 0% heat recovery efficiency			MVHR 82% heat recovery efficiency		
Airtightness (ACH n50)	5			3.0 with airtight membrane	2.0 with airtight membrane	1.5 with airtight membrane
Heater	50% heat pump (R32 refrigerant) 50% electric panel heater					
Hot water	100% electric HWC			100% heat pump (R744/CO2 refrigerant)		

## Case study 1 - Results

These are the results of the design work flow after going through the modelling and refinement process.

As can be seen below, the balance of the heat losses in all climates is relatively even across all of the building elements. For 6 Homestar

the total energy use increases as the climate becomes more severe. However the total energy use of the 8 Homestar homes remains relatively similar, demonstrating the higher level of performance no matter what climate.

### Auckland

#### 6 Homestar

- Annual space heating demand: 39.6
- Annual electricity demand: 43.5
- Overheating without mechanical cooling: 5.3%

#### 8 Homestar

- Annual space heating demand: 19.5
- Annual electricity demand: 28.8
- Overheating without mechanical cooling: 3.4%

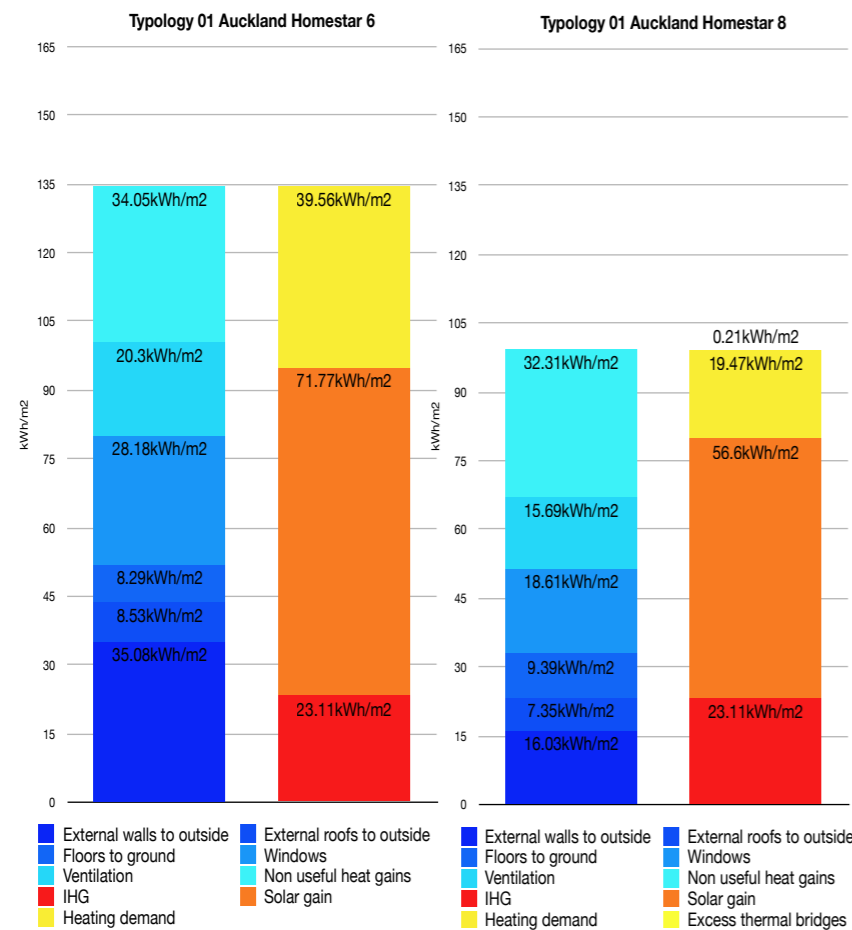

### Wellington

#### 6 Homestar

- Annual space heating demand: 58.7
- Annual electricity demand: 58.1
- Overheating without mechanical cooling: 1.6%

#### 8 Homestar

- Annual space heating demand: 21.8
- Annual electricity demand: 31.9
- Overheating without mechanical cooling: 1.1%

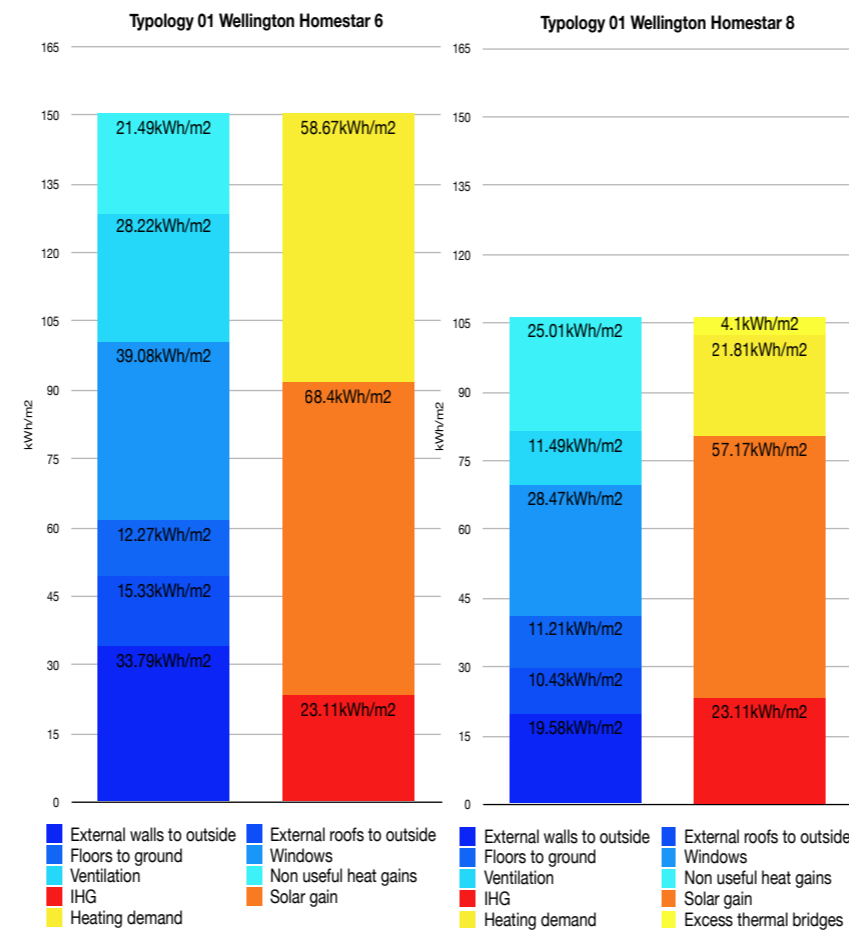

### Christchurch

#### 6 Homestar

- Annual space heating demand: 71.9
- Annual electricity demand: 68.2
- Overheating without mechanical cooling: 1.1%

#### 8 Homestar

- Annual space heating demand: 28
- Annual electricity demand: 36.8
- Overheating without mechanical cooling: 0.9%

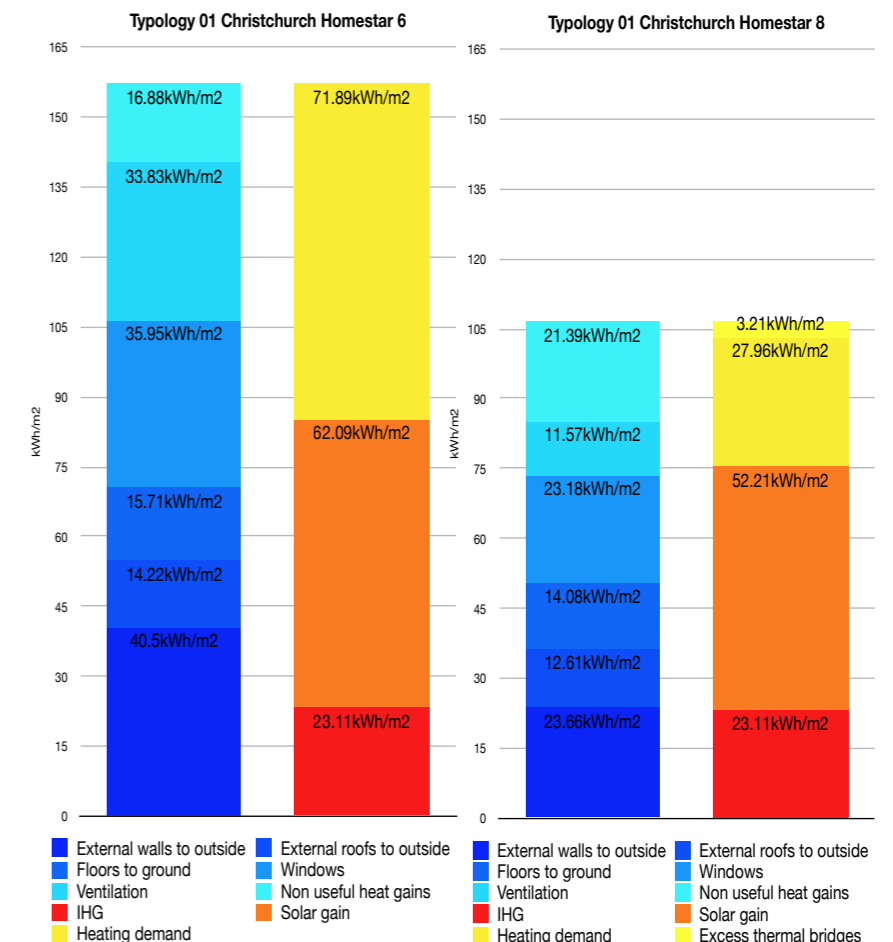

## Case study 1 - Costing (Auckland)

The following tables show the different specification upgrades needed from Building Code minimum, to achieve 6 Homestar and

8 Homestar in the three different climate zones, and the related costs for each element.

Case Study 01 - Auckland						
	Auckland					
	Building Code Minimum		Homestar 6		Homestar 8	
<b>Building total cost per m2</b>	\$3,783		\$3,818		\$3,994	
<b>Increase from Building Code minimum</b>	0.0%		0.1%		6.5%	
<b>Floor</b>	Suspended Floor with 140 insulation	\$25,235	Suspended Floor with 190 insulation	\$515	Suspended Floor with 190 insulation	\$515
<b>Walls</b>	90mm framing with R2.8 insulation	\$12,566	No change	-	+\$ for 45mm insulated services cavity	\$4,223
<b>Roof</b>	R7.0 insulation between trusses	\$6,180	No change	-	+\$ for increase to R7.7 insulation and insulated services cavity	\$2,060
<b>Window frames</b>	Thermally broken aluminium frame	\$14,111	+\$ for trickle vents	\$2,000	+\$ for standard UPVC frames & recessed flashings	\$4,233
<b>Window glass</b>	Low e argon filled, double glazing unit. Ug=1.3	\$14,111	No change	-	+ cost for double low-e argon exceptional	\$2,060
<b>Door panel</b>	Standard front door panel	\$1,493.50	No change	-	No change	-
<b>Ventilation</b>	Extractor fan in each bathroom and laundry	\$660	+\$ for continuous extract	\$1,040	+\$ for continuous extract	\$1,040
<b>Airtightness</b>	No airtight construction	-	No change	-	+\$ for airtightness membrane to walls and roof	\$6,180
<b>Heater</b>	1 X 1kW electric panel heater in each bedroom and 1 X 5kW heat pump in living room (Note: this is not a code requirement but a healthy home minimum standard for rental property and reflect most new developments)	\$4,120	No change	-	No change	-
<b>Hot water</b>	Electric hot water cylinder	\$4,000	No change	-	+\$ for heat pump hot water cylinder	\$1,500
<b>Additional cost</b>	-		\$3,555		\$21,811	



Case study 1 - Costing  
(Wellington)

Case Study 01 - Wellington						
	Wellington					
	Building Code Minimum		Homestar 6		Homestar 8	
Building total cost per m2	\$3,577		\$3,651		\$3,897	
Increase from Building Code minimum	0.0%		2.0%		8.4%	
<b>Floor</b>	Suspended Floor with 140 insulation	\$23,844	Suspended Floor with 190 insulation	\$490	Suspended Floor with 240 insulation	\$600
<b>Walls</b>	\$ 90mm framing with R2.8 insulation	\$11,875.90	+\$ for 140mm wall framing & 140 insulation	\$4,120	+\$ for 140mm wall framing & 140 insulation. +45mm insulated services cavity	\$6,180
<b>Roof</b>	\$ R7.0 insulation between trusses	\$5,840	No change	-	+\$ for increase to R7.7 insulation and insulated services cavity	\$2,060
<b>Window frames</b>	\$ Thermally broken aluminium frame	\$13,390	+\$ for trickle vents	\$2,000	+\$ for standard UPVC frames & recessed flashings	\$4017
<b>Window glass</b>	Low e argon filled, double glazing unit. Ug=1.3	\$13,390	No change	-	No change	
<b>Door panel</b>	\$ Standard front door panel	\$1,410	No change	-	+\$ for better door panel	\$460
<b>Ventilation</b>	\$ Extractor fan in each bathroom and laundry	\$630	+\$ for continuous extract	\$1,040	+\$ for MVHR	\$12,000
<b>Airtightness</b>	\$ No airtight construction	-	No change	-	+\$ for airtightness membrane to walls and roof	\$6,180
<b>Heater</b>	\$ 1 X 1kW electric panel heater in each bedroom and 1 X 5kW heat pump in living room (Note: this is not a code requirement but a healthy home minimum standard for rental property and reflect most new developments)	\$3,890	No change	-	No change	-
<b>Hot water</b>	\$ Electric hot water cylinder	\$3,800	No change	-	+\$ for heat pump hot water cylinder	\$1,500
<b>Additional cost</b>	-		\$7,650		\$32,997	

Case study 1 - Costing  
(Christchurch)

Case Study 01 - Christchurch						
	Christchurch					
	Building Code Minimum		Homestar 6		Homestar 8	
Building total cost per m2	\$3,715		\$3,835		\$4,097	
Increase from Building Code minimum	0.0%		3.1%		10.1%	
<b>Floor</b>	Suspended Floor with 140 insulation	\$24,352	Suspended Floor with 190 insulation	\$515	Suspended Floor with 240 insulation	\$824
<b>Walls</b>	\$ 90mm framing with R2.8 insulation	\$12,360	+\$ for 140mm wall framing & 140 insulation	\$4,120	+\$ for 140mm wall framing & 140 insulation. +45mm insulated services cavity	\$6,180
<b>Roof</b>	\$ R7.0 insulation between trusses	\$6,077	No change	-	+\$ for increase to R7.7 insulation and insulated services cavity	\$2,060
<b>Window frames</b>	\$ Thermally broken aluminium frame	\$13,900	+\$ for standard UPVC frames and trickle vents	\$4170	+\$ for high performance UPVC frames	\$7,500
<b>Window glass</b>	\$ Metro low-e Xtreme or Viridian PerformaTech Low-e, argon filled, double glazing unit	\$13,900	-\$ Metro low-e Xcel or Viridian Lightbridge Low-e, argon filled, double glazing unit	\$1,030	+ cost for triple low-e argon exceptional	\$2,600
<b>Door panel</b>	\$ Standard front door panel	\$1,470	No change	-	+\$ for better door panel	\$515
<b>Ventilation</b>	\$ Extractor fan in each bathroom and laundry	\$650	+\$ for continuous extract	\$1,040	+\$ for MVHR	\$12,000
<b>Airtightness</b>	\$ No airtight construction		No change	-	+\$ for airtightness membrane to walls and roof	\$6,180
<b>Heater</b>	\$ 1 X 1kW electric panel heater in each bedroom and 1 X 5kW heat pump in living room (Note: this is not a code requirement but a healthy home minimum standard for rental property and reflect most new developments)	\$4,120	No change	-	No change	-
<b>Hot water</b>	\$ Electric hot water cylinder	\$3,950	+\$ for heat pump hot water cylinder	\$1,500	+\$ for heat pump hot water cylinder	\$1,500
<b>Additional cost</b>	-		\$12,375		\$39,359	



## Case study 2

### Single storey standalone house - high glazing

Conditioned floor area:	93m <sup>2</sup>
Thermal mass type:	Concrete slab, single level timber
Window to wall ratio:	28%
Form factor:	4.0

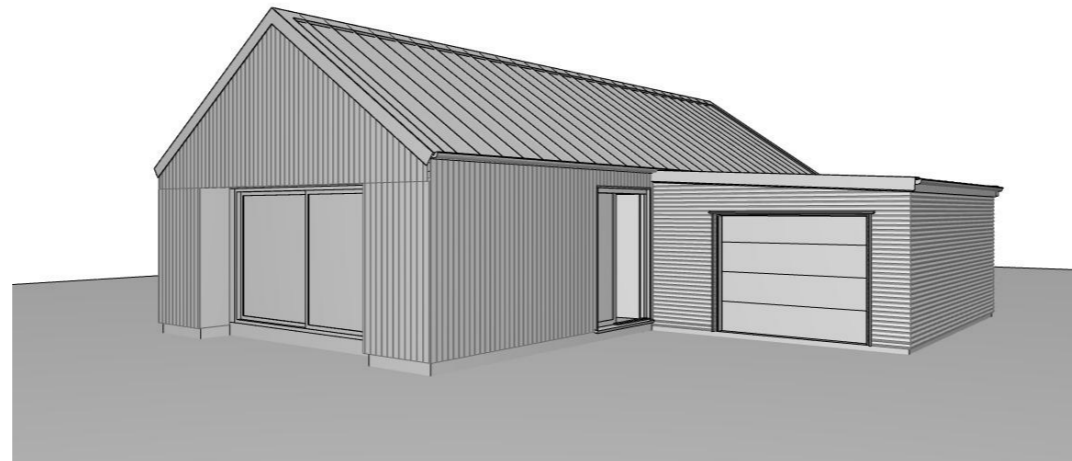

EXTERIOR 1



EXTERIOR 2

Case study 2 is the same single storey, standalone home with three bedrooms, a bathroom and WC, as case study 1, however it is on a concrete slab, has an attached garage, and has a higher glazing ratio. These changes will make it harder to achieve higher levels of performance due to the slab edge and garage slab connection thermal bridges, and while the higher levels of glazing will allow more 'free' heat, they will also contribute to overheating levels.

### Performance considerations for case study 2

- ✦ A concrete slab with light timber frame on top poses challenges for insulation around and underneath the floor to enable continuous insulation of the thermal envelope. Proprietary or SED (specific engineering design) fully insulated slab system must be used.
- ✦ A concrete slab with light timber frame on top means the only common concern for thermal bridging is limited to the perimeter and the junction between the house and the garage. A fully insulated slab system with 30-50mm XPS thermal break would generally meet the fRsi requirement in both situations.
- ✦ High glazing to wall ratio makes the overheating targets hard to achieve, which would likely require additional effort and cost to design and build specific shading devices.
- ✦ High glazing to wall ratios normally come with higher heat loss but also higher heat gain too. Careful design and window placement is always required to achieve the right balance.
- ✦ Thermal mass from a concrete slab has a small positive effect on both heating demand and overheating.



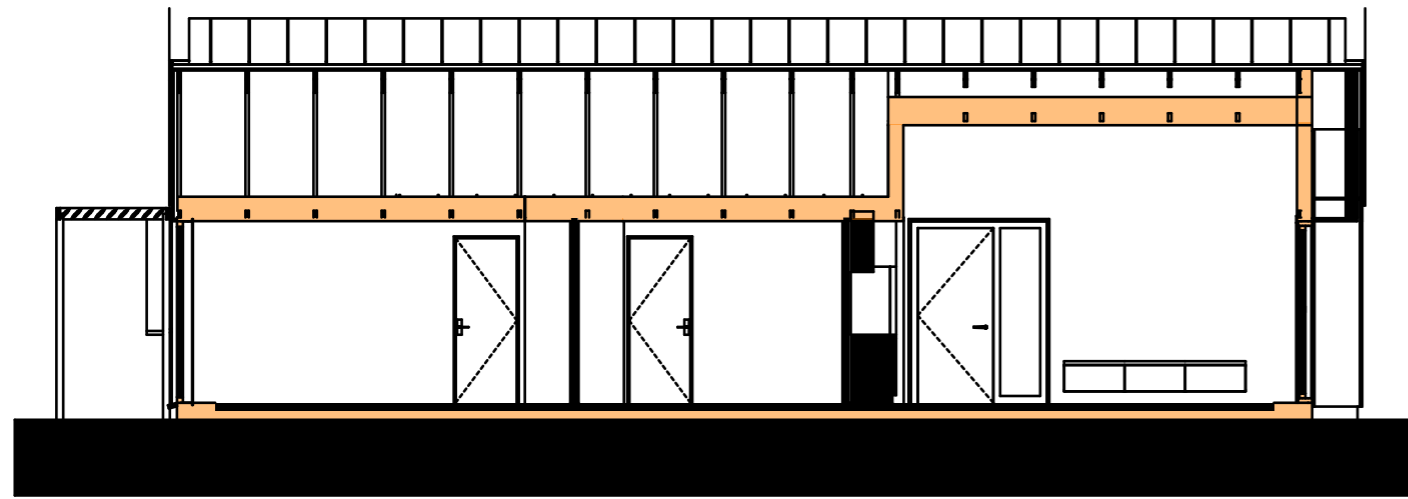

SECTION C

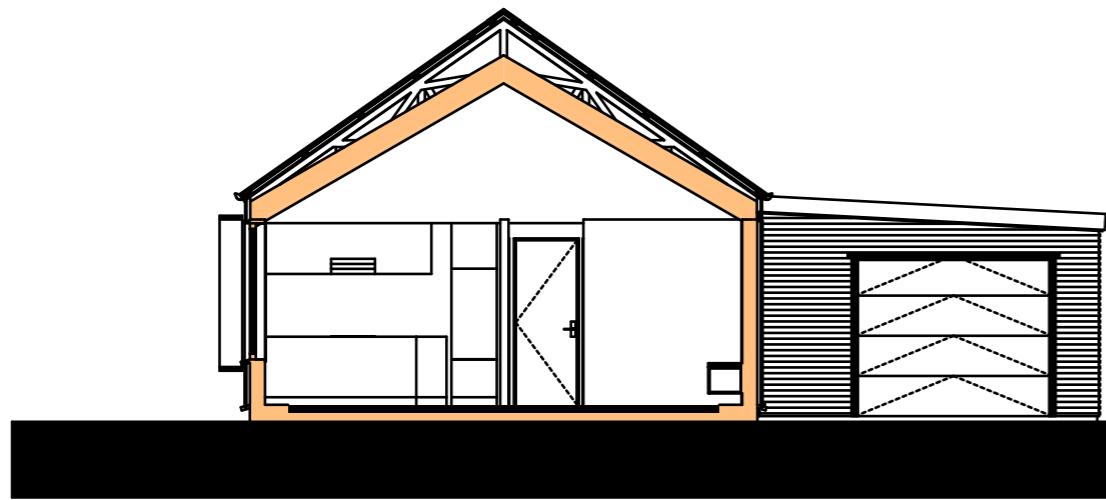

SECTION A

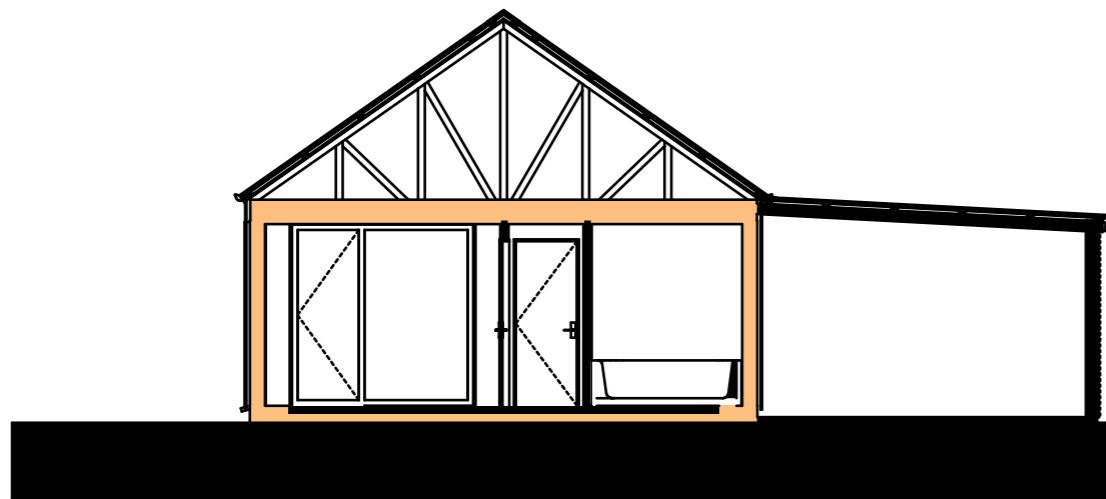

SECTION B

Thermal Envelope

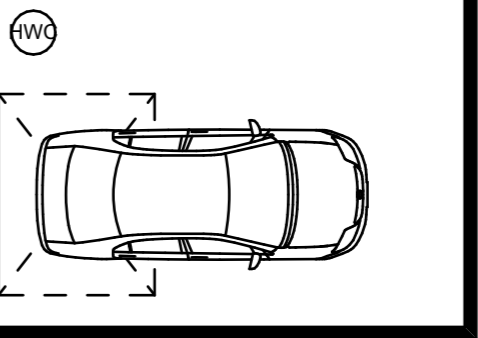
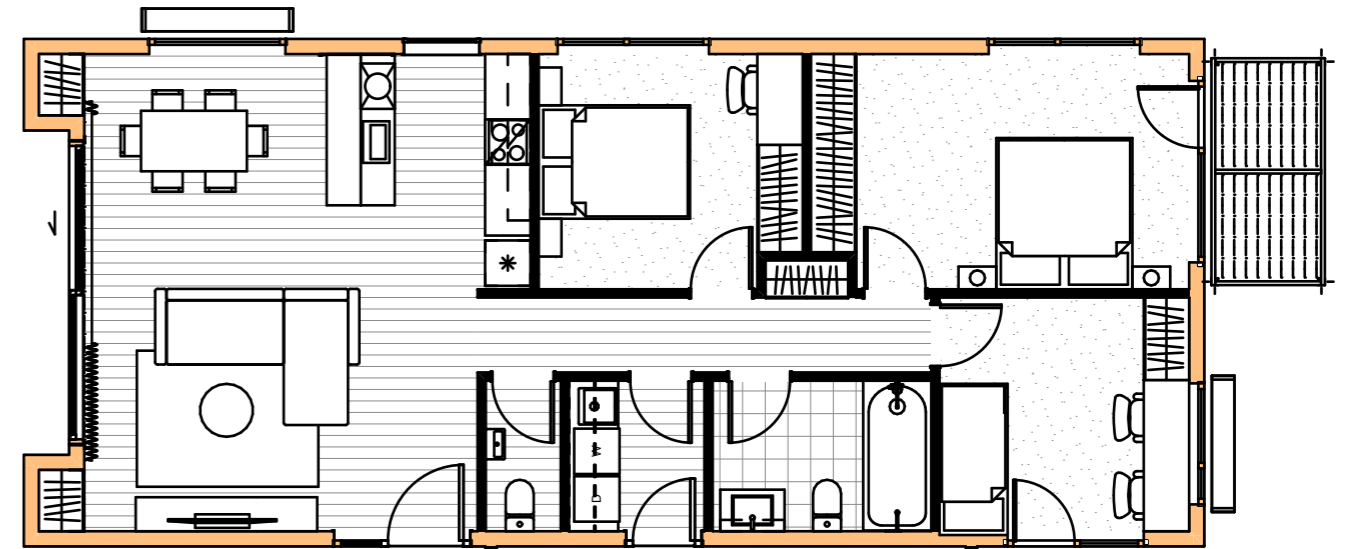

GROUND FLOOR

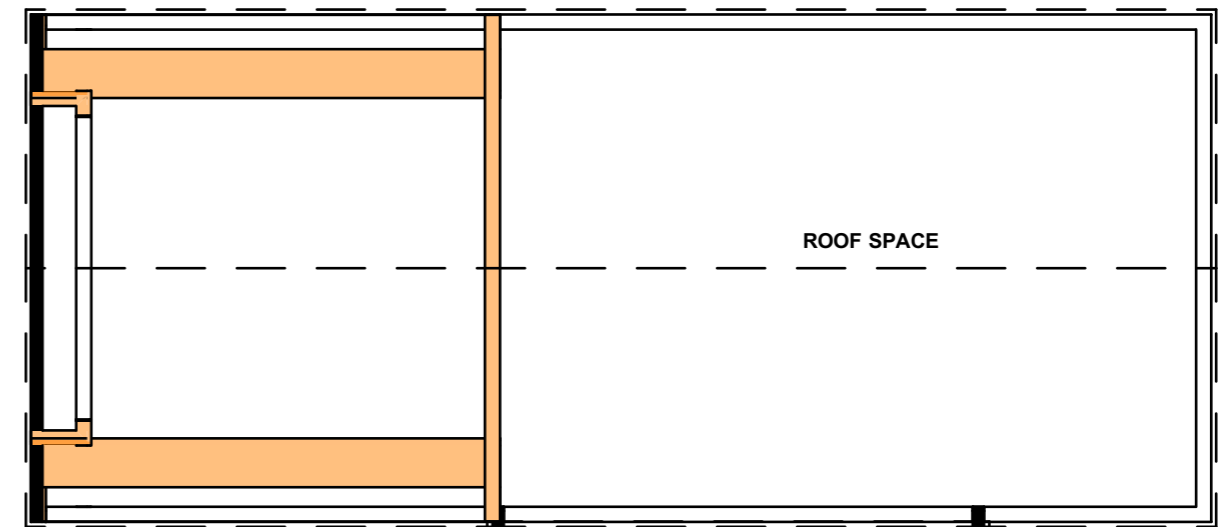

ROOF SPACE

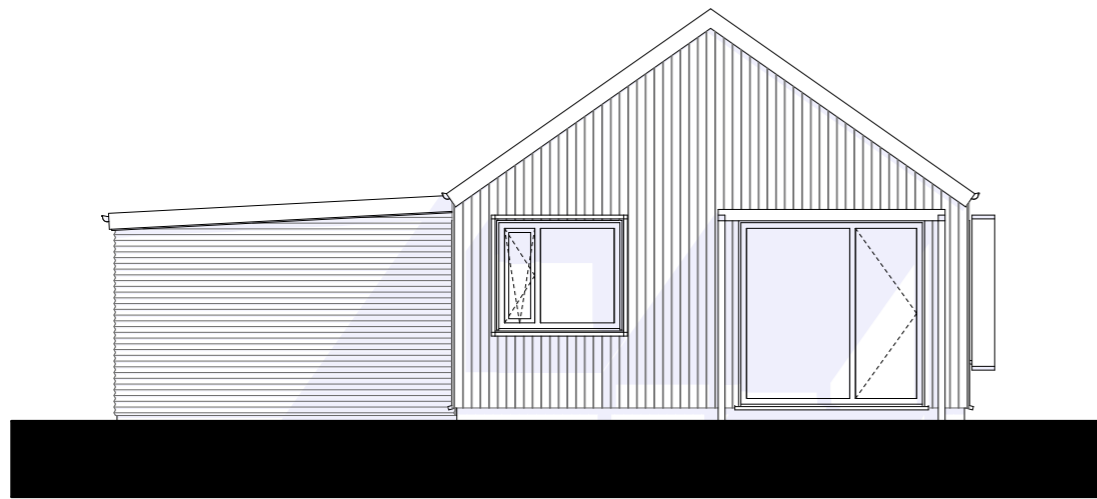

EAST ELEVATION PROPOSED

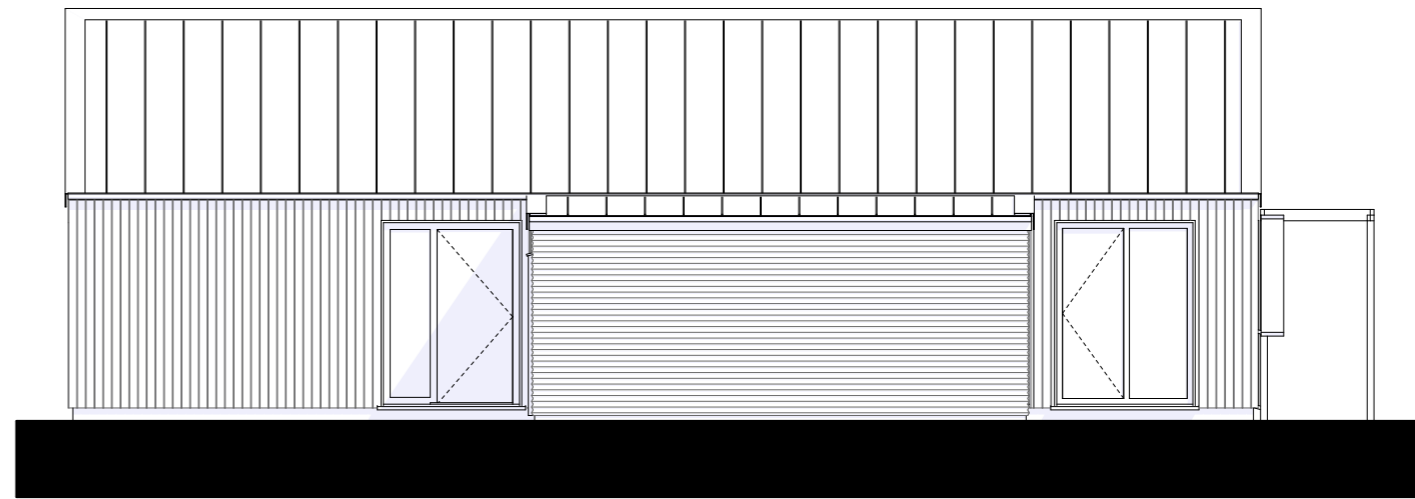

SOUTH ELEVATION PROPOSED

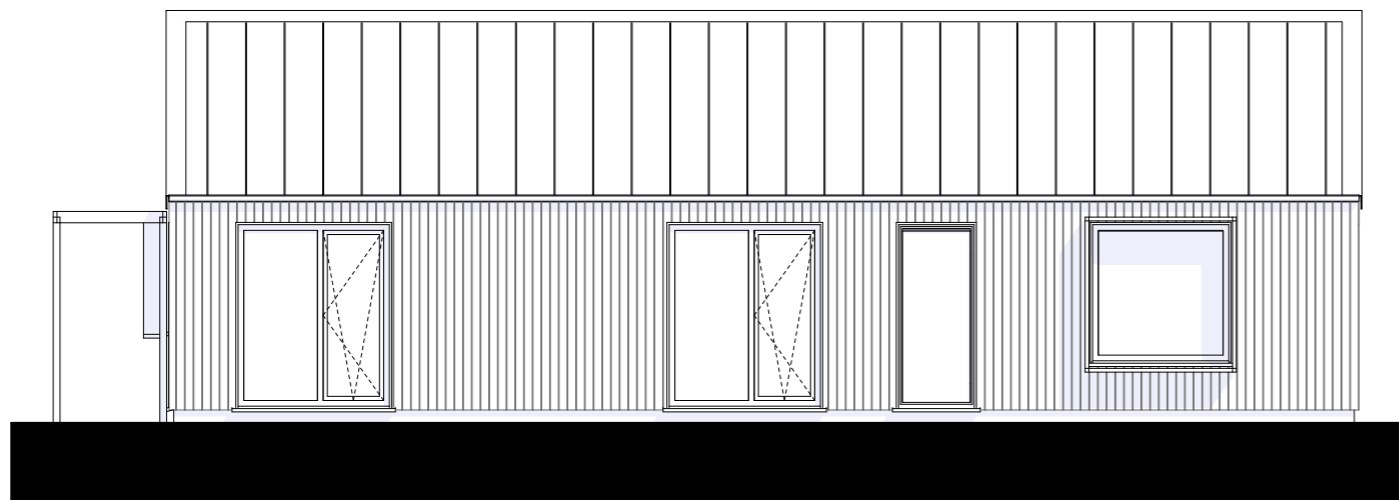

NORTH ELEVATION PROPOSED



WEST ELEVATION PROPOSED

## Case study 2 - Specification

	AKL HS6	WLG HS6	CHCH HS6	AKL HS8	WLG HS8	CHCH HS8
Floor	FLOOR: Waffle Slab 220 solid pods with ribs and 50mm EPS under			FLOOR: Waffle Slab 300 solid pods with ribs and 50mm EPS under		
Wall	WALL: 90 framing (30% timber content)	WALL: 140 framing (30% timber content)		WALL: 90 framing + 45 service cavity with airtight membrane (30% timber content)	WALL: 140 framing + 45 service cavity with airtight membrane optimised (15% timber content)	
Roof	ROOF: R5.2 Rafter/Truss roof			ROOF: 6.6 Rafter/Truss roof	ROOF: R7.7 Rafter/Truss roof with insulated ceiling cavity	
Thermal Bridges	ECCHO fully insulated slab 300 90mm timber clad	ECCHO fully insulated slab 300 140mm timber clad		HPCD 39: EWFS – 140/45 stud wall insulated waffle pod slab edge insulation and full insulation under ribs		
Window frame	ECCHO Aluminium thermally broken			ECCHO generic PVC frame (recessed)		Optimal PVC frame (supplier specific data, recessed)
Glass	ECCHO Double Low-e Arg Best (Ug=1.30)			ECCHO Double Low-e Arg Exceptional (Ug=1.10)	ECCHO Double Low-e Arg Best (Ug=1.30)	Triple Low-e Arg Exceptional (supplier specific data, Ug=0.60, g=0.49)
Door panel	ECCHO Standard door			Insulated front door panel (supplier specific data)		
Shading objects	External blind for sliding door Louvre/ pergola on 1 window Window surround on 2 windows Internal blinds on all windows					
Ventilation	Continuous extract 0% heat recovery efficiency			MVHR 82% heat recovery efficiency		
Airtightness (ACH n50)	5			3.0 with airtight membrane	2.0 with airtight membrane	1.5 with airtight membrane
Heater	50% heat pump (R32 refrigerant) 50% electric panel heater					
Hot water	100% electric HWC			100% heat pump (R744/CO2 refrigerant)		



## Case study 2 - Results

### Auckland

#### 6 Homestar

- Annual space heating demand: 36.9
- Annual electricity demand: 51
- Overheating without mechanical cooling: 4.5%

#### 8 Homestar

- Annual space heating demand: 18.6
- Annual electricity demand: 30.1
- Overheating without mechanical cooling: 3.2%

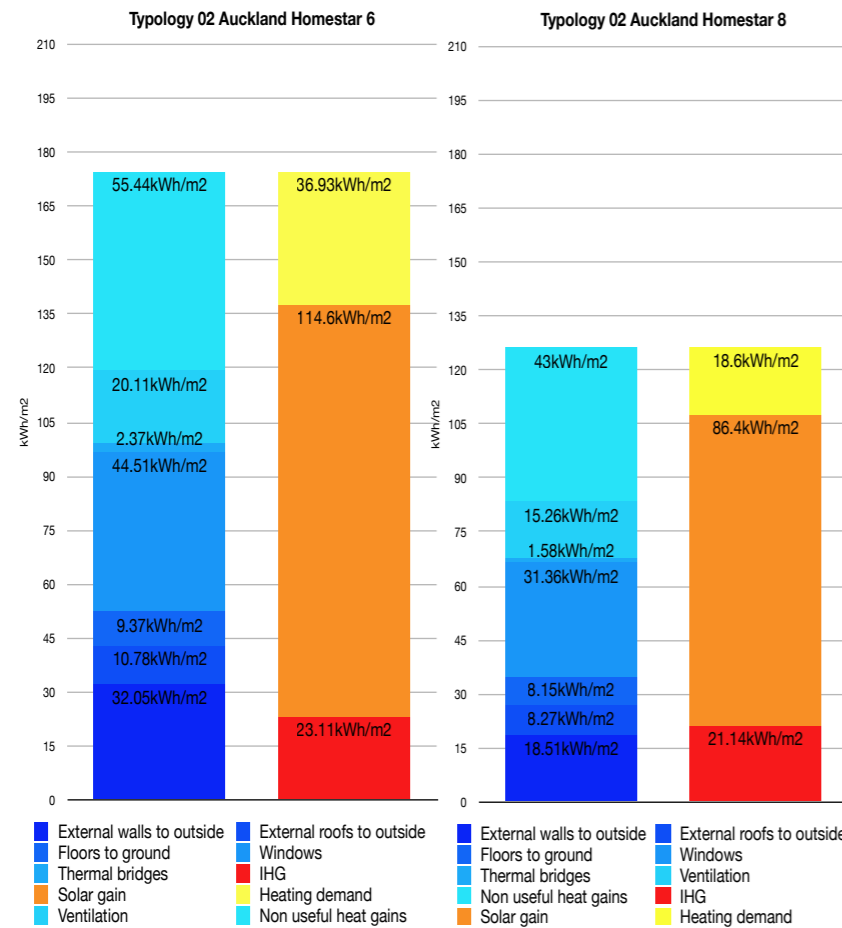

### Wellington

#### 6 Homestar

- Annual space heating demand: 52.7
- Annual electricity demand: 63.7
- Overheating without mechanical cooling: 1.0%

#### 8 Homestar

- Annual space heating demand: 22.8
- Annual electricity demand: 34.6
- Overheating without mechanical cooling: 1.0%

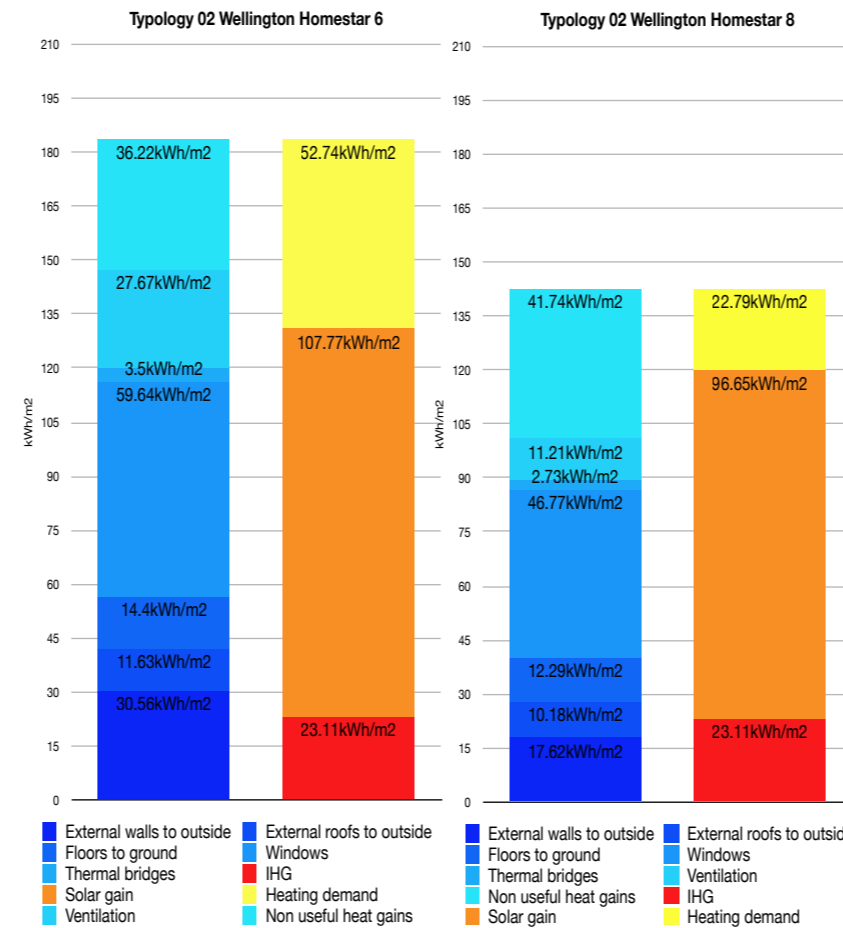

### Christchurch

#### 6 Homestar

- Annual space heating demand: 75.8
- Annual electricity demand: 70.9
- Overheating without mechanical cooling: 1.0%

#### 8 Homestar

- Annual space heating demand: 26.7
- Annual electricity demand: 38.1
- Overheating without mechanical cooling: 0.8%

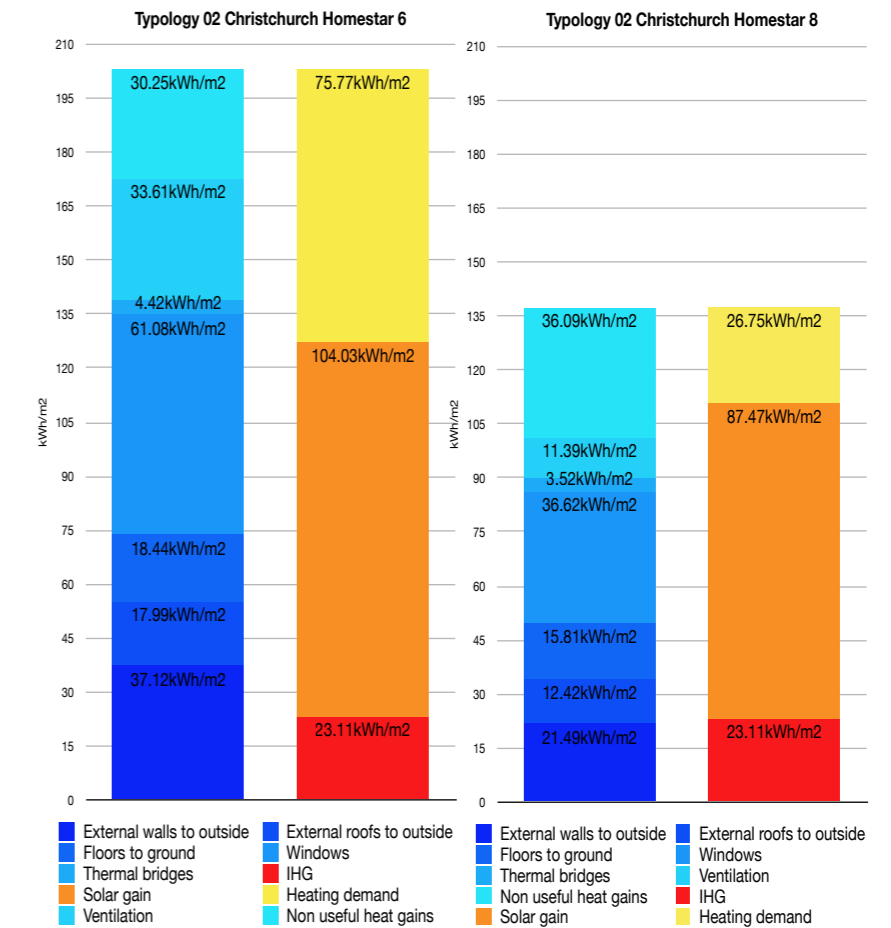

## Case study 2 - Costing (Auckland)

The following tables show the different specification upgrades needed from Building Code minimum, to achieve 6 Homestar and

8 Homestar in the three different climate zones, and the related costs for each element.

Case Study 02 - Auckland						
	Auckland					
	Building Code Minimum		Homestar 6		Homestar 8	
<b>Building total cost per m2</b>	\$3,543.		\$3,580.		\$3,697.	
<b>Increase from Building Code minimum</b>	0.0%		1.0%		4.3%	
<b>Floor</b>	Raft slab with 220 pods and R1 edge insulation (30mm XPS with render over)	\$40,000.	Raft slab with 220 pods and R1.3 50mm EPS under AND at perimeter	\$1,500.	Raft slab with 220 pods and R1.3 50mm EPS under AND at perimeter	\$1,500.
<b>Walls</b>	90mm framing with R2.8 insulation	\$17,352.	No change	-	90 framing + 45 service cavity with airtight membrane (30% timber content)	\$4,120.
<b>Roof</b>	R7.0 insulation between trusses	\$7,847.	R5.2 Rafter/Truss roof	\$400.	6.6 Rafter/Truss roof	\$1,064.
<b>Window frames</b>	Thermally broken aluminium frame	\$13,900.	+ trickle vent	\$2,000.	ECCHO generic PVC frame (recessed)	\$4,170.
<b>Window glass</b>	Argon filled, double glazing unit. Ug=1.3	\$13,900.	No change	-	ECCHO Double Low-e Arg Exceptional (Ug=1.10)	\$2,000.
<b>Door panel</b>	Standard front door panel	\$1,470.	No change	-	No change	-
<b>Ventilation</b>	Extractor fan in each bathroom and laundry	\$650.	Continuous extract 0% heat recovery efficiency	\$1,040.	Continuous extract 0% heat recovery efficiency	\$1,040.
<b>Airtightness</b>	No airtight construction	\$.	5	\$.	3 with airtight membrane	\$5,080.
<b>Heater</b>	1 X 1kW electric panel heater in each bedroom and 1 X 5kW heat pump in living room (Note: this is not a code requirement but a healthy home minimum standard for rental property and reflect most new developments)	\$4,120.	No change	-	No change	-
<b>Hot water</b>	Electric hot water cylinder	\$3,950.	No change	-	100% heat pump (R744/CO2 refrigerant)	\$1,500.
<b>Additional cost</b>	-		\$4,940.		\$20,474.	

Case study 2 - Costing  
(Wellington)

Case Study 02 - Wellington						
	Wellington					
	Building Code Minimum		Homestar 6		Homestar 8	
Building total cost per m2	\$3,348.		\$3,425.		\$3,643.	
Increase from Building Code minimum	0.0%		2.3%		8.8%	
<b>Floor</b>	Raft slab with 220 pods and R1 edge insulation (30mm XPS with render over)	\$38,000.	Raft slab with 220 pods and R1.3 50mm EPS under AND at perimeter	\$1,500.	Waffle Slab 300 solid pods with ribs and 50mm EPS under	\$9,044.
<b>Walls</b>	90mm framing with R2.8 insulation	\$16,484.	140 framing (30% timber content)	\$5,320.	140 framing + 45 service cavity with airtight membrane optimised (15%)	\$6,000.
<b>Roof</b>	R7.0 insulation between trusses	\$7,455.	R5.2 Rafter/Truss roof	\$400.	R7.7 Rafter/Truss roof with insulated ceiling cavity	\$1,064.
<b>Window frames</b>	Thermally broken aluminium frame	\$13,390.	+ trickle vent	\$2,000.	ECCHO generic PVC frame (recessed)	\$4,170.
<b>Window glass</b>	Argon filled, double glazing unit. Ug=1.3	\$13,390.	No change	-	No change	-
<b>Door panel</b>	Standard front door panel	\$1,410.	No change	-	Insulated front door panel (supplier specific data)	\$500.
<b>Ventilation</b>	Extractor fan in each bathroom and laundry	\$630.	Continuous extract 0% heat recovery efficiency	\$1,040.	MVHR 82% heat recovery efficiency	\$12,000.
<b>Airtightness</b>	No airtight construction	\$.	5	\$.	2.0 with airtight membrane	\$5,080.
<b>Heater</b>	1 X 1kW electric panel heater in each bedroom and 1 X 5kW heat pump in living room (Note: this is not a code requirement but a healthy home minimum standard for rental property and reflect most new developments)	\$3,890.	No change	-	No change	-
<b>Hot water</b>	Electric hot water cylinder	\$3,800.	No change	-	100% heat pump (R744/CO2 refrigerant)	\$1,500.
<b>Additional cost</b>	-		\$10,260.		\$39,358.	



Case study 2 - Costing  
(Christchurch)

Case Study 02 - Christchurch						
	Christchurch					
	Building Code Minimum		Homestar 6		Homestar 8	
Building total cost per m2	\$3,479.		\$3,558.		\$3,794.	
Increase from Building Code minimum	0.0%		2.3%		9.1%	
<b>Floor</b>	Raft slab with 220 pods and R1 edge insulation (30mm XPS with render over)	\$39,000.	Raft slab with 220 pods and R1.3 50mm EPS under AND at perimeter	\$1,600.	Waffle Slab 300 solid pods with ribs and 50mm EPS under	\$9,310.
<b>Walls</b>	90mm framing with R2.8 insulation	\$17,000.	140 framing (30% timber content)	\$5,500.	140 framing + 45 service cavity with airtight membrane optimised (15%)	\$6,200.
<b>Roof</b>	R7.0 insulation between trusses	\$7,700.	R5.2 Rafter/Truss roof	\$400.	R7.7 Rafter/Truss roof with insulated ceiling cavity	\$1,080.
<b>Window frames</b>	Thermally broken aluminium frame	\$13,650.	+ trickle vent	\$2,000.	Optimal PVC frame (supplier specific data, recessed)	\$4,155.
<b>Window glass</b>	Argon filled, double glazing unit. Ug=1.1	\$13,850.	No change	-	Triple Low-e Arg Exceptional (supplier specific data, Ug=0.60, g=0.49)	\$2,080.
<b>Door panel</b>	Standard front door panel	\$1,450.	No change	-	Insulated front door panel (supplier specific data)	\$500.
<b>Ventilation</b>	Extractor fan in each bathroom and laundry	\$640.	Continuous extract 0% heat recovery efficiency	\$1,040.	MVHR 82% heat recovery efficiency	\$12,000.
<b>Airtightness</b>	No airtight construction	\$.	5	\$.	1.5 with airtight membrane	\$5,080.
<b>Heater</b>	1 X 1kW electric panel heater in each bedroom and 1 X 5kW heat pump in living room (Note: this is not a code requirement but a healthy home minimum standard for rental property and reflect most new developments)	\$4,210.	No change	-	No change	-
<b>Hot water</b>	Electric hot water cylinder	\$3,950.	No change	-	100% heat pump (R744/CO2 refrigerant)	\$1,500.
<b>Additional cost per m2</b>	-		<b>\$10,540.</b>		<b>\$41,905.</b>	



## Case study 3

### Multi-unit two storey terraced homes

Conditioned floor area:	66m <sup>2</sup>
Thermal mass type:	Timber floor - due to insulation on top of slab
Window to wall ratio:	22%
Form factor:	2.6

Case study 3 is a terrace of 5x two storey, two bedroom and one bathroom homes. They have a simple form and medium levels of glazing, with a top-insulated concrete slab, timber framing and insulated flat ceilings. It is in an urban location so the site shading levels are higher.

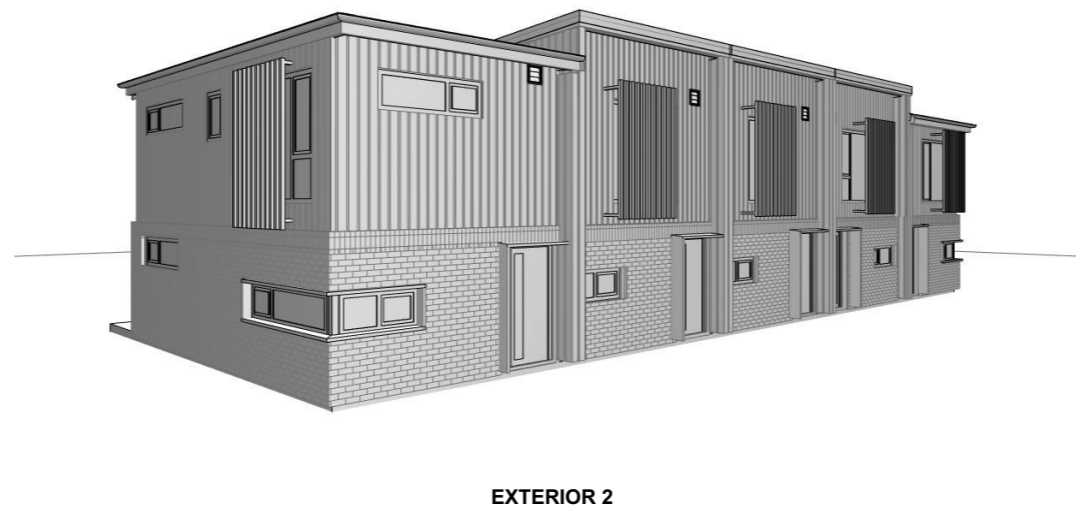
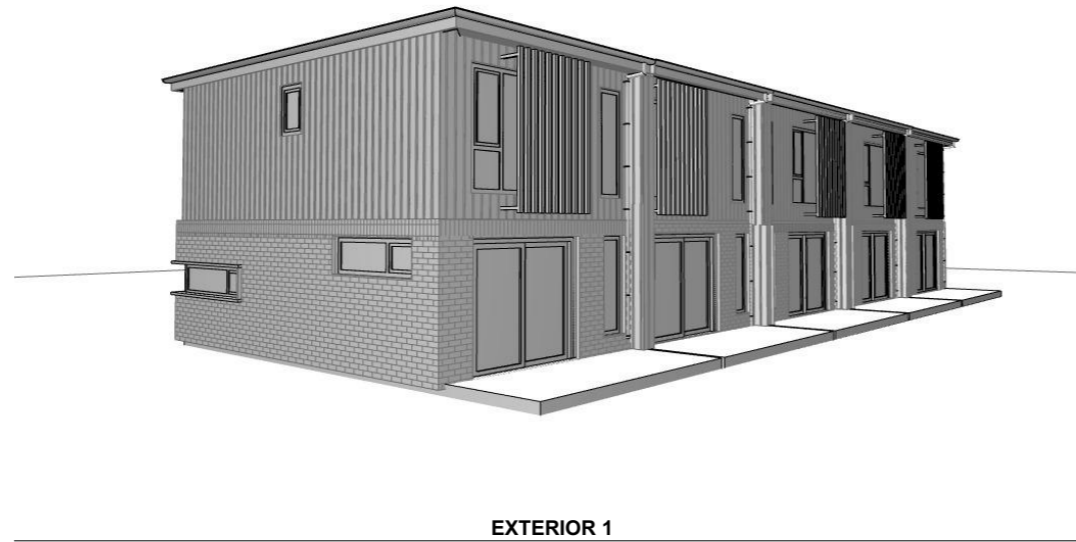

**NB.** All units were modelled and based on the results the worst case for heat demand and the worst case for overheating were established – only the results for the worst case for heat demand is shown here, but in reality you would need to submit both for Homestar assessment.

### Performance considerations for case study 3

- ✦ In this typology there are both north-facing and south-facing units that perform very differently. One is the worst case in heating demand and the other is the worst case in overheating. According to Homestar convention, both scenarios must meet all mandatory minimum targets individually. This may push the level of specifications to be even higher than the examples in case studies 1 and 2.
- ✦ When the same set of specifications cannot fulfil the performance targets for both houses, minor tweaks to mitigate either or both buildings may be necessary. Orientation specific glazing selection is the most typical example. Secondly, different design or window sizing can achieve the desired performance outcome although this triggers additional design work.
- ✦ Due to the smaller volume to absorb solar gain, the overheating potential is likely to be higher than the example of typologies 1 and 2. Custom vertical shading screens, or external shutters may be required to meet the overheating target. In an urban environment, these devices are often required for privacy reasons, so the overheating targets do not necessarily incur extra cost.
- ✦ Brick/schist cladding with larger concrete footing causes a detail where continuous insulation / thermal break cannot be achieved. The resulting thermal bridge will fail the fRsi requirement. The easiest solution is to insulate on top of the slab. This construction method has been used in many passive houses in New Zealand although it is not yet mainstream.
- ✦ Concrete slab with insulation over and two storeys of light timber frame on top means the entire house is easy to insulate and is easy to add more insulation to both floor and roof when required (although the increase of the over slab insulation does trigger changes to stud height etc.)
- ✦ Concrete slab with insulation over has little to no potential for thermal bridging. In most cases, this will automatically fulfil the fRsi thermal bridge and mould assessment requirement.
- ✦ Thermal mass from the concrete slab cannot be counted because there is insulation on top to isolate it. Lightweight timber construction must be selected as thermal mass option in ECCHO.

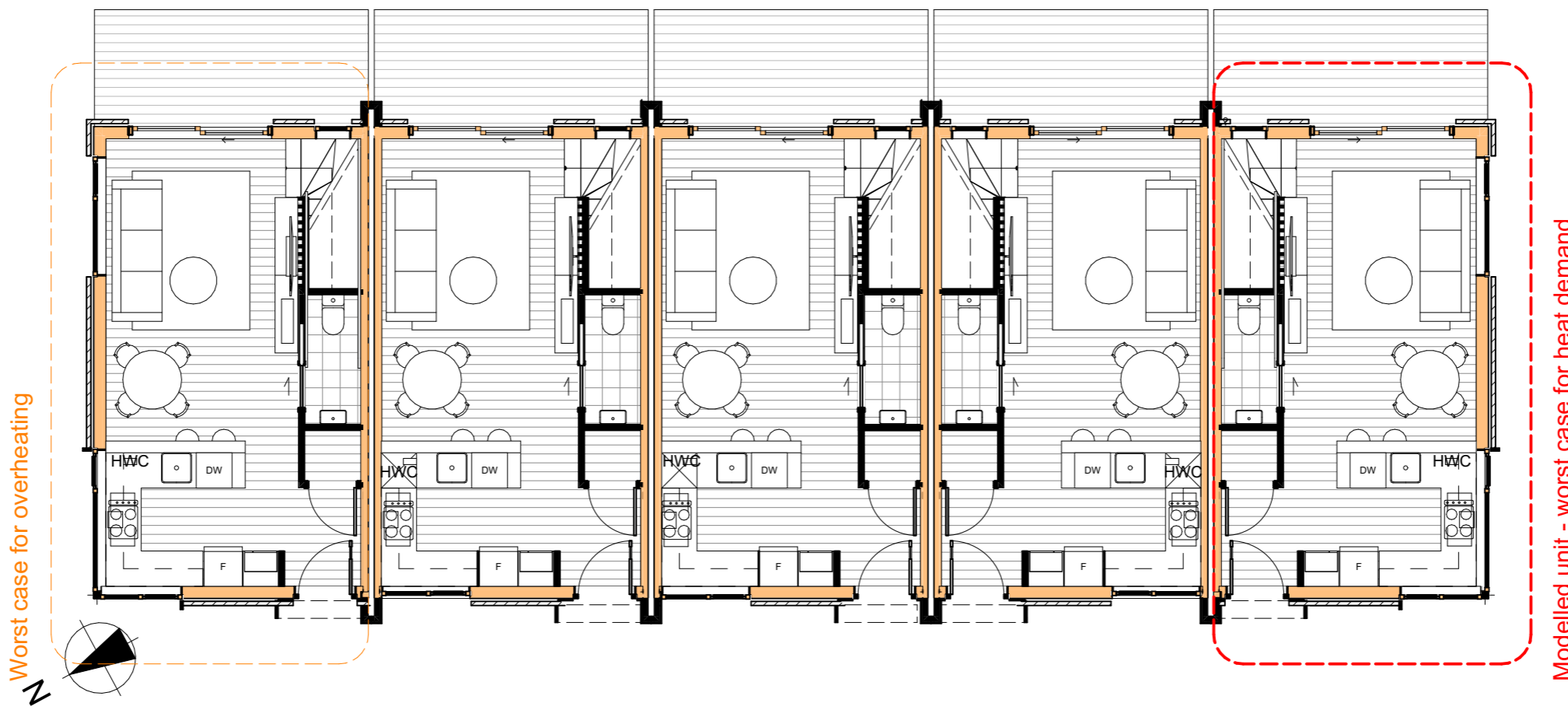

GROUND FLOOR PLAN

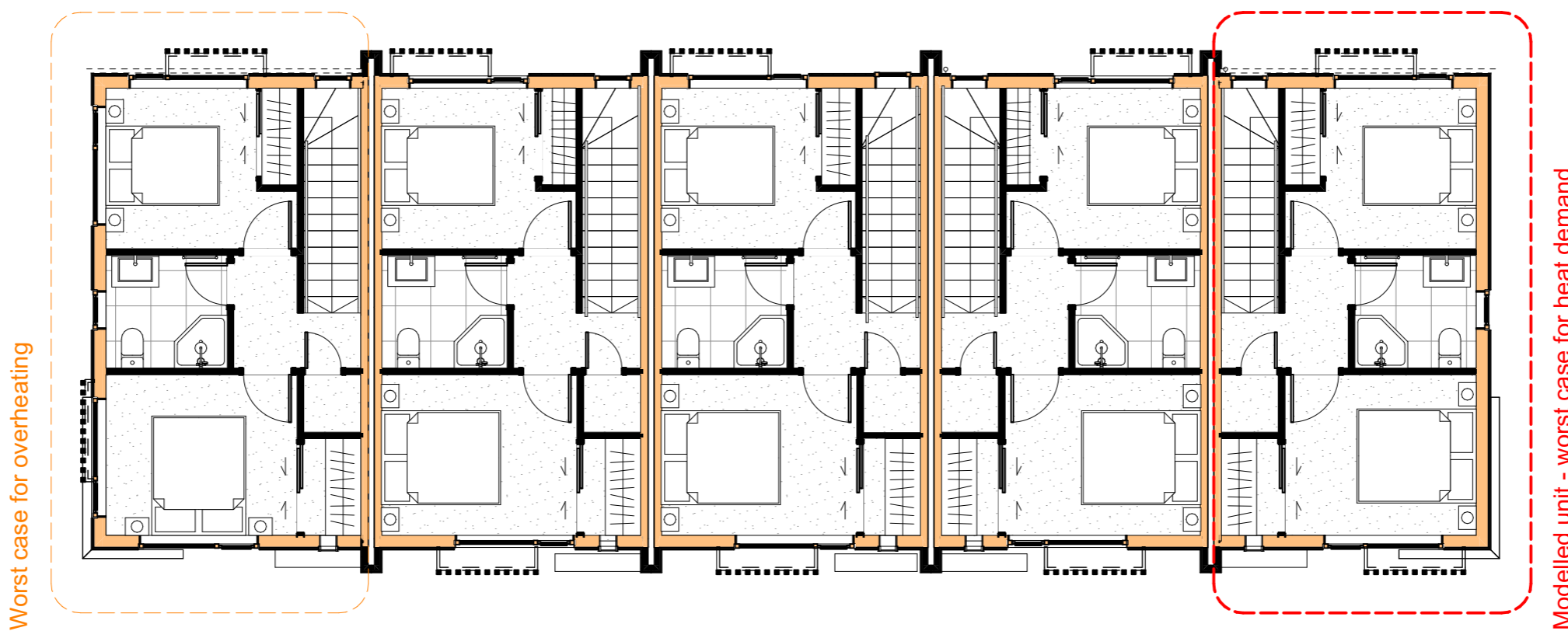

FIRST FLOOR PLAN



Modelled unit - worst case for heat demand

Worst case for overheating

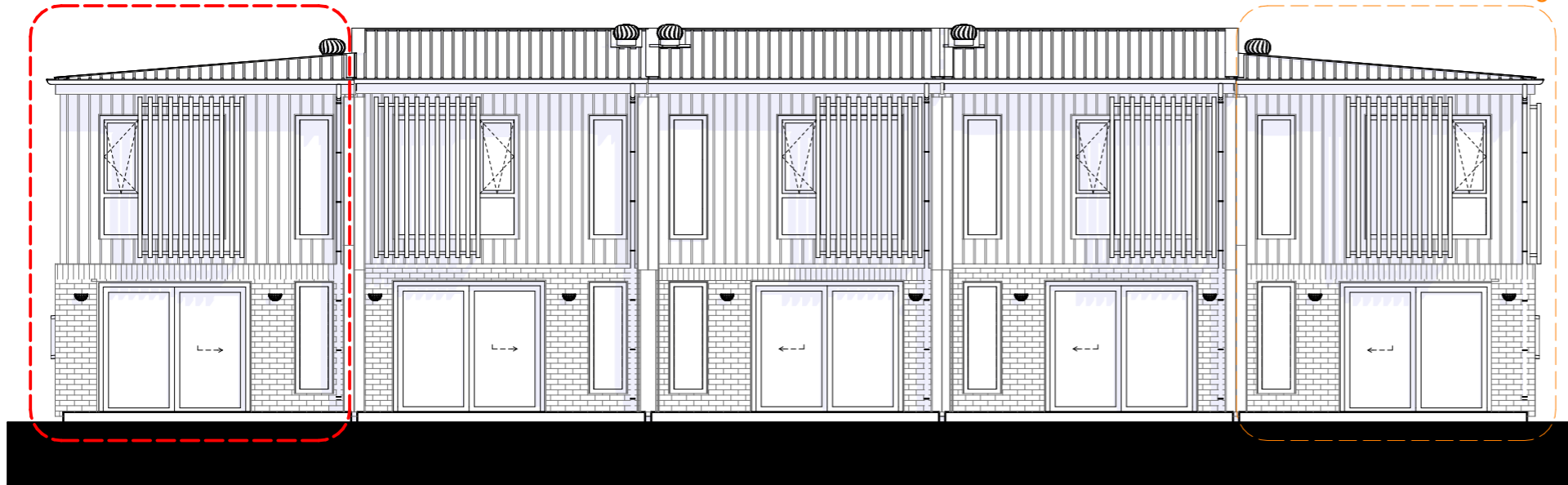

EAST ELEVATION

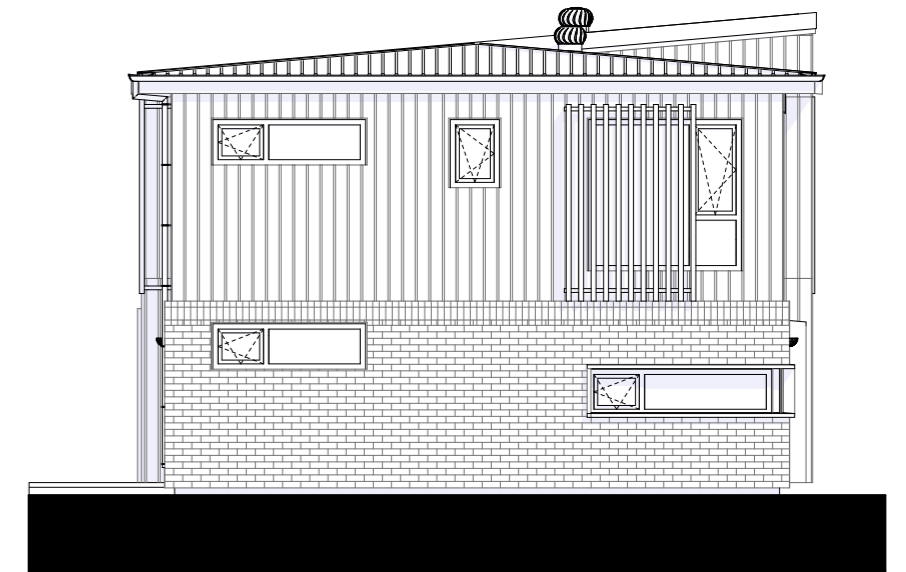

NORTH ELEVATION

Modelled unit - worst case for heat demand

Worst case for overheating

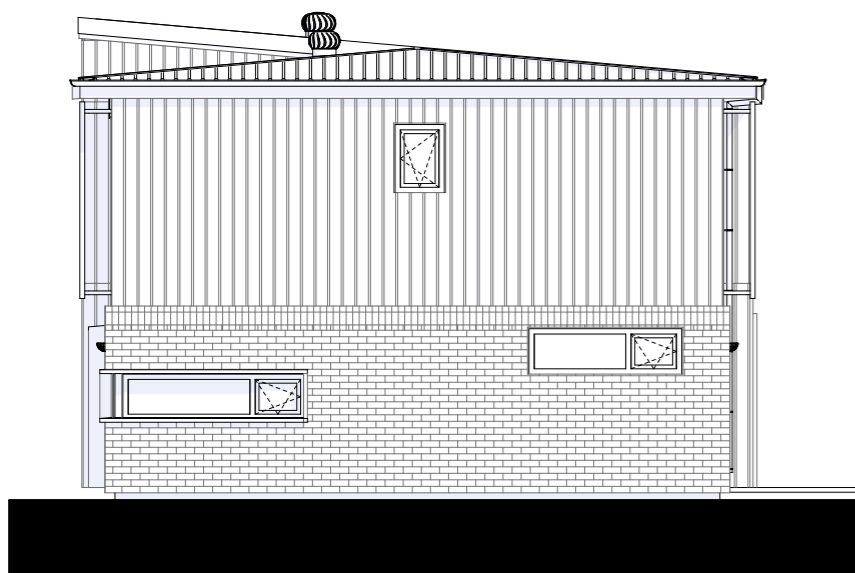

SOUTH ELEVATION

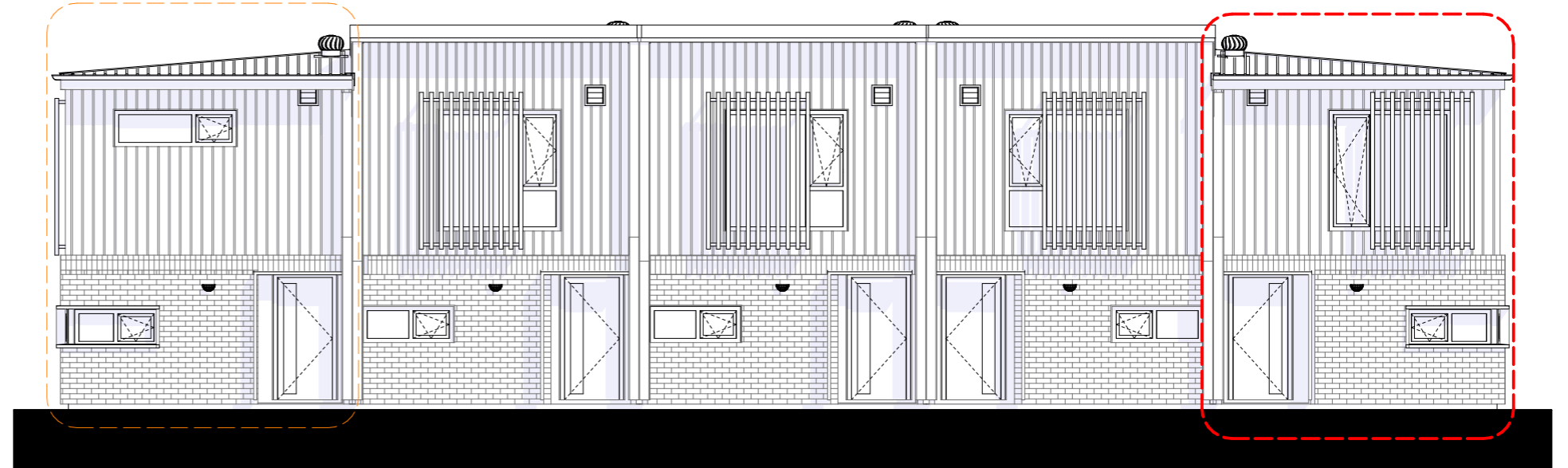

WEST ELEVATION

Modelled unit - worst case for heat demand

Worst case for overheating

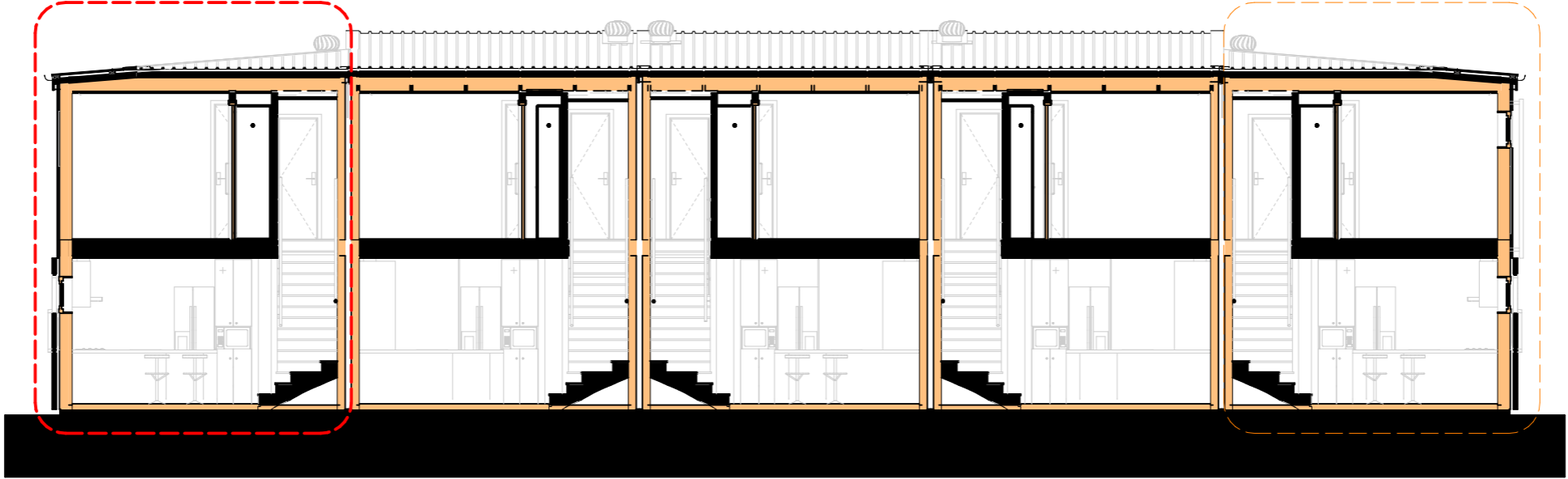

SECTION A - UNIT 1-5

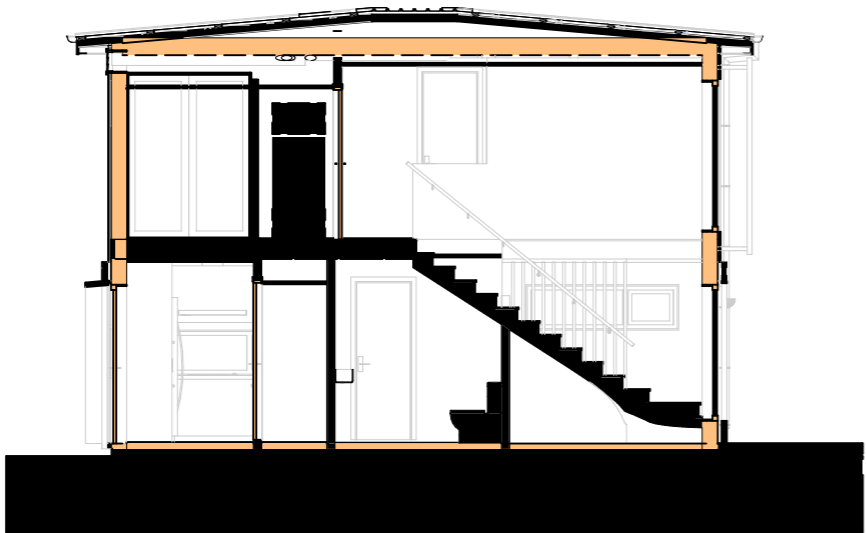

UNIT 1 SECTION 02

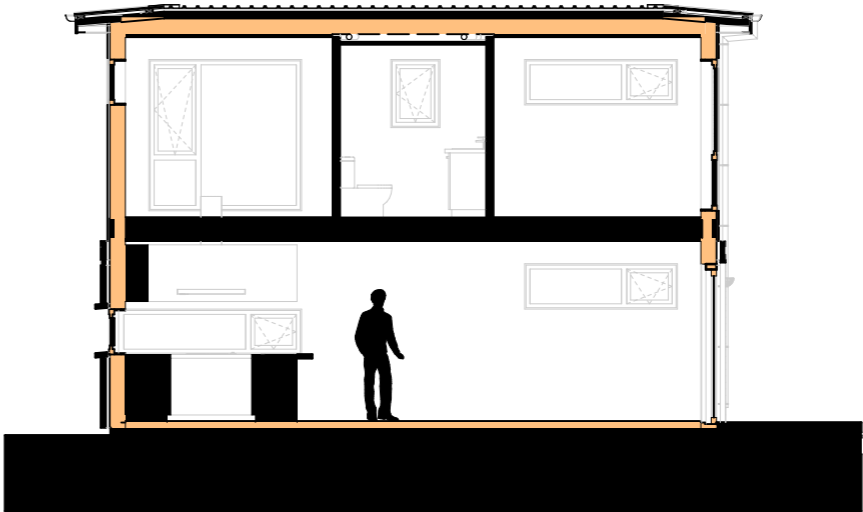

UNIT 1 SECTION 03

### Case study 3 - Specification

	AKL HS6	WLG HS6	CHCH HS6	AKL HS8	WLG HS8	CHCH HS8
Floor	FLOOR: 50mm XPS on top of slab			FLOOR: 100mm XPS on top of slab		
Wall	WALL: 140 framing (30% timber content)			WALL: 140 framing + 45 service cavity with airtight membrane optimised (15% timber content)		
Roof	ROOF: R5.2 Rafter/Truss roof			ROOF: R6.6 Rafter/Truss roof	ROOF: R7.7 Rafter/Truss roof with insulated ceiling cavity	
Thermal Bridges	HPCD 43: EWFS – Brick veneer waffle pod slab on ground insulation above the slab 140/45 timber frame			HPCD 43: EWFS – Brick veneer waffle pod slab on ground insulation above the slab 140/45 timber frame HPCH 08 EWEC External Wall - External corner 140/45 stud wall no extra timber HPCD 57 TCEA Truss Ceiling Roof Eaves - Truss roof raised heel to maintain insulation thickness		
Window frame	ECCHO Aluminium thermally broken			ECCHO generic PVC frame (recessed)		Optimal PVC frame (supplier specific data, recessed)
Glass	Specific double low-e argon filled glazing based on supplier's specific data (Ug = 1.0, g-value = 0.41)*	ECCHO Double Low-e Arg Best (Ug=1.30)		Specific double low-e argon filled glazing based on supplier's specific data (Ug = 1.1, g-value = 0.35)*	ECCHO Double Low-e Arg Best (Ug=1.30)	ECCHO triple Low-e Arg Best (Ug=0.70, g-value unknown)
Door panel	ECCHO Standard door			Insulated front door panel (supplier specific data)		
Shading objects	Specific designed privacy screen with 60%-70% perforation Window surround on front door and kitchen windows Internal blinds on all windows					
Ventilation	Continuous extract 0% heat recovery efficiency			MVHR 82% heat recovery efficiency		
Airtightness (ACH n50)	5			3.0 with airtight membrane	2.0 with airtight membrane	1.5 with airtight membrane
Heater	50% heat pump (R32 refrigerant) 50% electric panel heater					
Hot water	100% electric HWC			100% heat pump (R744/CO2 refrigerant)		

## Case study 3 - Results

### Auckland

#### 6 Homestar

- Annual space heating demand: 38.5
- Annual electricity demand: 44.2
- Overheating without mechanical cooling: 3.7%

#### 8 Homestar

- Annual space heating demand: 19.0
- Annual electricity demand: 30.8
- Overheating without mechanical cooling: 1.6%

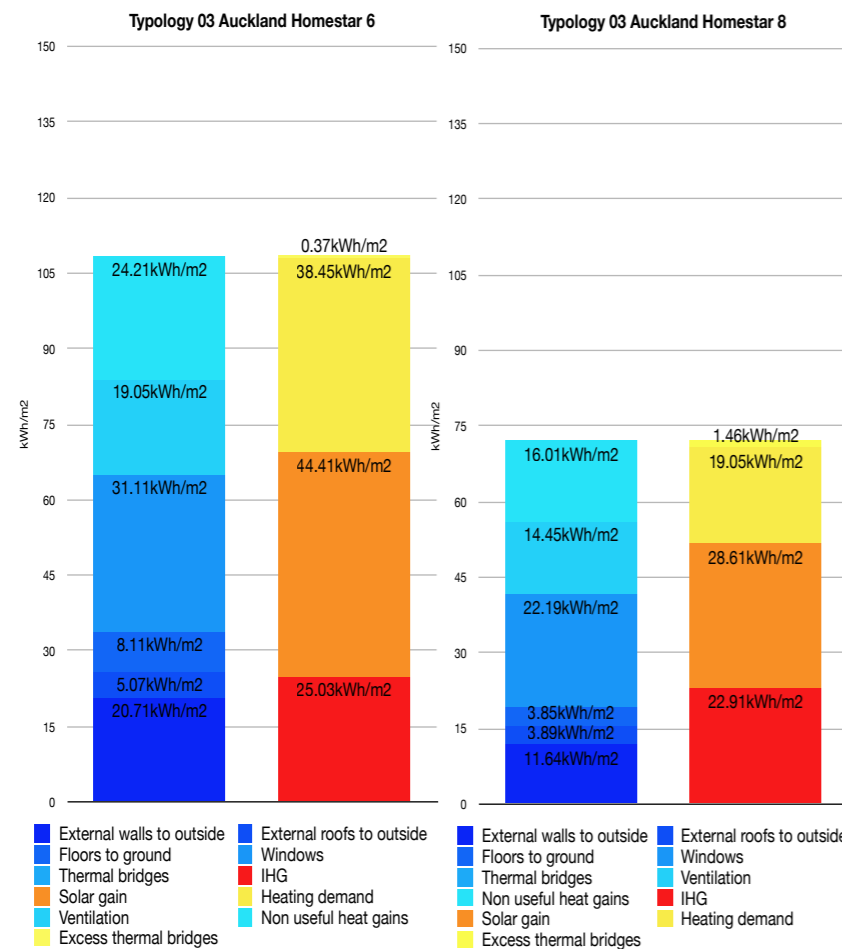

### Wellington

#### 6 Homestar

- Annual space heating demand: 58.1
- Annual electricity demand: 59.0
- Overheating without mechanical cooling: 3.2%

#### 8 Homestar

- Annual space heating demand: 21.5
- Annual electricity demand: 34.9
- Overheating without mechanical cooling: 2.1%

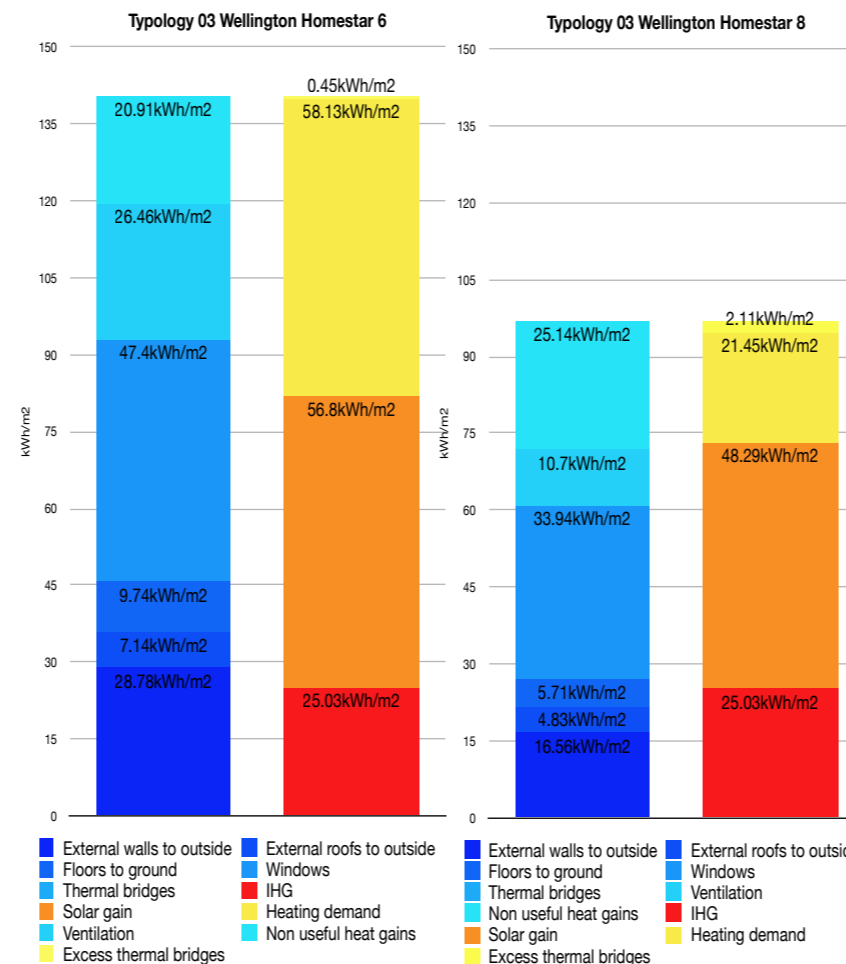

### Christchurch

#### 6 Homestar

- Annual space heating demand: 72.5
- Annual electricity demand: 69.9
- Overheating without mechanical cooling: 2.0%

#### 8 Homestar

- Annual space heating demand: 26.6
- Annual electricity demand: 39.2
- Overheating without mechanical cooling: 1.2%

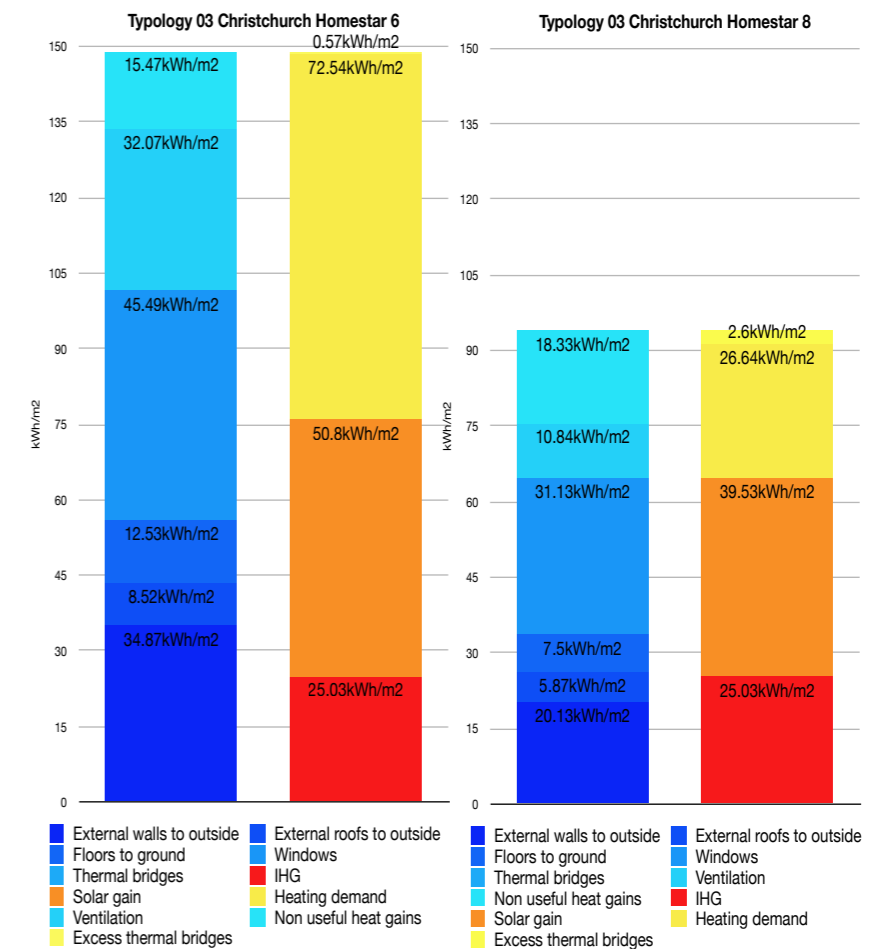



### Case study 3 - Costing (Auckland)

The following tables show the different specification upgrades needed from Building Code minimum, to achieve 6 Homestar and

8 Homestar in the three different climate zones, and the related costs for each element.

Case Study 03 - Auckland						
	Auckland					
	Building Code Minimum		Homestar 6		Homestar 8	
Building total cost per m2	\$3,362		\$3,458		\$3,572	
Increase from Building Code minimum	0.0%		2.9%		6.2%	
<b>Floor</b>	Standard slab with 100mm EPS under slab (intermittent between thickenings etc) and R1 edge insulation (30mm XPS with render over)	\$8,580	50mm XPS on top of slab	\$330	100mm XPS on top of slab	\$660
<b>Walls</b>	90mm framing with R2.8 insulation	\$9,620	140 framing (30% timber content)	\$3,330	140 framing + 45 service cavity with airtight membrane optimised (15%)	\$4,810
<b>Roof</b>	R7.0 insulation between trusses	\$825	R5.2 Rafter/Truss roof	\$99	R6.6 Rafter/Truss roof	\$264
<b>Window frames</b>	Thermally broken aluminium frame	\$11,235	+ trickle vent	\$1,600	ECCHO generic PVC frame (recessed)	\$3,415
<b>Window glass</b>	Argon filled, double glazing unit. Ug=1.1	\$11,385	Specific double low-e argon filled glazing based on supplier's specific data (Ug = 1.0, g-value = 0.41)*	\$315	Specific double low-e argon filled glazing based on supplier's specific data (Ug = 1.1, g-value = 0.35)*	\$600
<b>Door panel</b>	Standard front door panel	\$1,470	No change	-	Insulated front door panel (supplier specific data)	\$500
<b>Ventilation</b>	Extractor fan in each bathroom and laundry	\$440	Continuous extract 0% heat recovery efficiency	\$670	Continuous extract 0% heat recovery efficiency	\$670
<b>Airtightness</b>	No airtight construction	\$0	5	\$0	3 with airtight membrane	\$1,500
<b>Heater</b>	1 X 1kW electric panel heater in each bedroom and 1 X 5kW heat pump in living room (Note: this is not a code requirement but a healthy home minimum standard for rental property and reflect most new developments)	\$3,780	No change	-	No change	-
<b>Hot water</b>	Electric hot water cylinder	\$3,950	No change	-	100% heat pump (R744/CO2 refrigerant)	\$1,500
<b>Additional cost</b>	-		\$6,344		\$13,919	

Case study 3 - Costing  
(Wellington)

Case Study 03 - Wellington						
	Wellington					
	Building Code Minimum		Homestar 6		Homestar 8	
Building total cost per m2	\$3,177		\$3,258		\$3,533	
Increase from Building Code minimum	0.0%		2.5%		11.2%	
<b>Floor</b>	Standard slab with 100mm EPS under slab (intermittent between thickenings etc) and R1 edge insulation (30mm XPS with render over)	\$8,150	50mm XPS on top of slab	\$396	100mm XPS on top of slab	\$825
<b>Walls</b>	90mm framing with R2.8 insulation	\$9,140	140 framing (30% timber content)	\$2,640	140 framing + 45 service cavity with airtight membrane optimised (15%)	\$3,300
<b>Roof</b>	R7.0 insulation between trusses	\$800	No change	-	R7.7 Rafter/Truss roof with insulated ceiling cavity	\$990
<b>Window frames</b>	Thermally broken aluminium frame	\$10,670	+ trickle vent	\$1,600	ECCHO generic PVC frame (recessed)	\$3,223
<b>Window glass</b>	Argon filled, double glazing unit. Ug=1.3	\$10,820	No change	-	ECCHO Double Low-e Arg Best (Ug=1.30)	\$1,700
<b>Door panel</b>	Standard front door panel	\$1,410	No change	-	Insulated front door panel (supplier specific data)	\$500
<b>Ventilation</b>	Extractor fan in each bathroom and laundry	\$440	Continuous extract 0% heat recovery efficiency	\$700	MVHR 82% heat recovery efficiency	\$10,000
<b>Airtightness</b>	No airtight construction	\$0	5	\$0	2 with airtight membrane	\$1,500
<b>Heater</b>	1 X 1kW electric panel heater in each bedroom and 1 X 5kW heat pump in living room (Note: this is not a code requirement but a healthy home minimum standard for rental property and reflect most new developments)	\$3,600	No change	-	No change	-
<b>Hot water</b>	Electric hot water cylinder	\$3,800	No change	-	100% heat pump (R744/CO2 refrigerant)	\$1,500
<b>Additional cost</b>	-		\$5,336		\$23,538	

Case study 3 - Costing  
(Christchurch)

Case Study 03 - Christchurch						
	Christchurch					
	Building Code Minimum		Homestar 6		Homestar 8	
Building total cost per m2	\$3,302		\$3,387		\$3,666	
Increase from Building Code minimum	0.0%		2.6%		11.0%	
<b>Floor</b>	Standard slab with 100mm EPS under slab (intermittent between thickenings etc) and R1 edge insulation (30mm XPS with render over)	\$8,425	50mm XPS on top of slab	\$495	100mm XPS on top of slab	\$924
<b>Walls</b>	90mm framing with R2.8 insulation	\$9,450	140 framing (30% timber content)	\$2,772	140 framing + 45 service cavity with airtight membrane optimised (15%)	\$3,630
<b>Roof</b>	R7.0 insulation between trusses	\$810	No change	-	R7.7 Rafter/Truss roof with insulated ceiling cavity	\$1,155
<b>Window frames</b>	Thermally broken aluminium frame	\$11,035	+ trickle vent	\$1,600	Optimal PVC frame (supplier specific data, recessed)	\$3,332
<b>Window glass</b>	Argon filled, double glazing unit. Ug=1.1	\$11,185	No change	-	ECCHO triple Low-e Arg Best (Ug=0.70, g-value unknown)	\$1,800
<b>Door panel</b>	Standard front door panel	\$1,450	No change	-	Insulated front door panel (supplier specific data)	\$500
<b>Ventilation</b>	Extractor fan in each bathroom and laundry	\$440	Continuous extract 0% heat recovery efficiency	\$750	MVHR 82% heat recovery efficiency	\$10,500
<b>Airtightness</b>	No airtight construction	\$0	5	\$0	1.5 with airtight membrane	\$1,620
<b>Heater</b>	1 X 1kW electric panel heater in each bedroom and 1 X 5kW heat pump in living room (Note: this is not a code requirement but a healthy home minimum standard for rental property and reflect most new developments)	\$3,700	No change	-	No change	-
<b>Hot water</b>	Electric hot water cylinder	\$3,880	No change	-	100% heat pump (R744/CO2 refrigerant)	\$1,500
<b>Additional cost</b>	-		\$5,617		\$24,037	



## Case study 4

### Multi-unit two storey terraced homes

Conditioned floor area:	79m <sup>2</sup>
Thermal mass type:	Timber floor on piles for upper storey units and concrete slab, single level timber for ground floor units
Window to wall ratio:	22% (based on south-facing ground floor unit as worst case)
Form factor:	2.4 (based on south-facing ground floor unit as worst case)



3D VIEW 01



3D VIEW 02

**NB. All units were modelled and based on the results the worst case for heat demand and the worst case for overheating were established – only the results for the worst case for heat demand is shown here, but in reality both would need to be submitted for the Homestar assessment. for Homestar assessment.**

Case study 4 is a block of 12 two bedroom, two bathroom apartments. The block is constructed with a concrete slab ground floor, and timber frame for the upper floors. It is in an urban location so the site shading levels are higher.

### Performance considerations for case study 4

- ✦ There are multiple scenarios to assess before we are able to determine the actual worst-case for heating demand and overheating.
- ✦ Ground level south > It is reasonable to assume this is the worst case for heating demand because there is a larger heat loss area while having limited solar gain.
- ✦ Level 1 north > Assumption cannot be made without modelling because there is small heat loss area (no floor or roof as part of the thermal envelope) while having large solar gain.
- ✦ Level 1 east-west > Assumption cannot be made without modelling because there is minimal heat loss area while having east and west exposure.
- ✦ Level 2 north > Assumption cannot be made without modelling because there is a larger heat loss area while having the highest heat gain.
- ✦ Additional thermal mass variation due to separated floors.
- ✦ Ground floor units have a concrete slab floor and single level timber walls, level 1 and level 2 units have a timber floor and timber walls.
- ✦ Ground level units' thermal envelopes have large percentage of floor area and no roof area.
- ✦ Level 1 units' thermal envelopes have no floor, no roof, and 100% walls.
- ✦ Level 2 units' thermal envelopes have large percentage of roof area and no floor area.
- ✦ Increased importance on glazing selection. Due to the limited ability to create specific floor, wall, roof, and window frame solutions, glazing selections become critically important to ensure consistent and Homestar compliant performance across all apartment units. Not only orientation specific but also floor specific glazing selection may be required.
- ✦ Overall, it is easier to keep apartment units warm but harder to manage overheating.



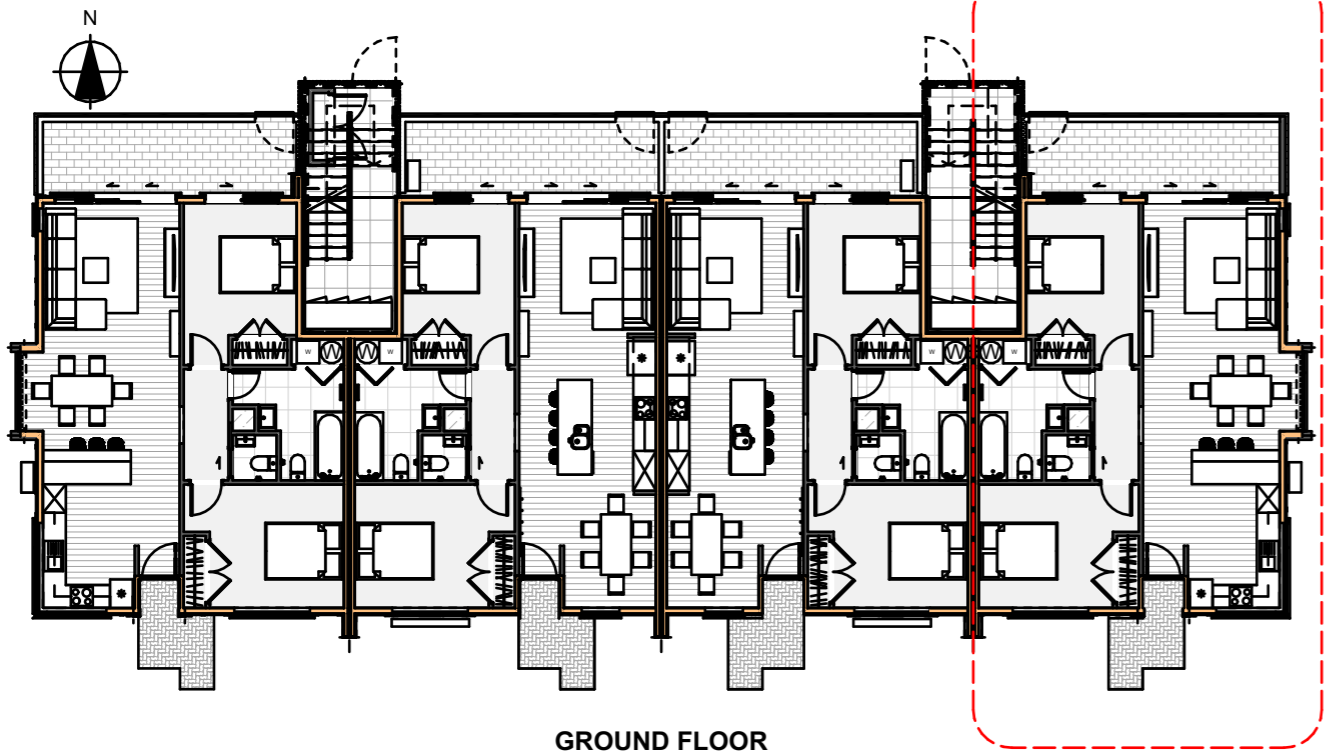

Modelled unit - worst case for heat demand

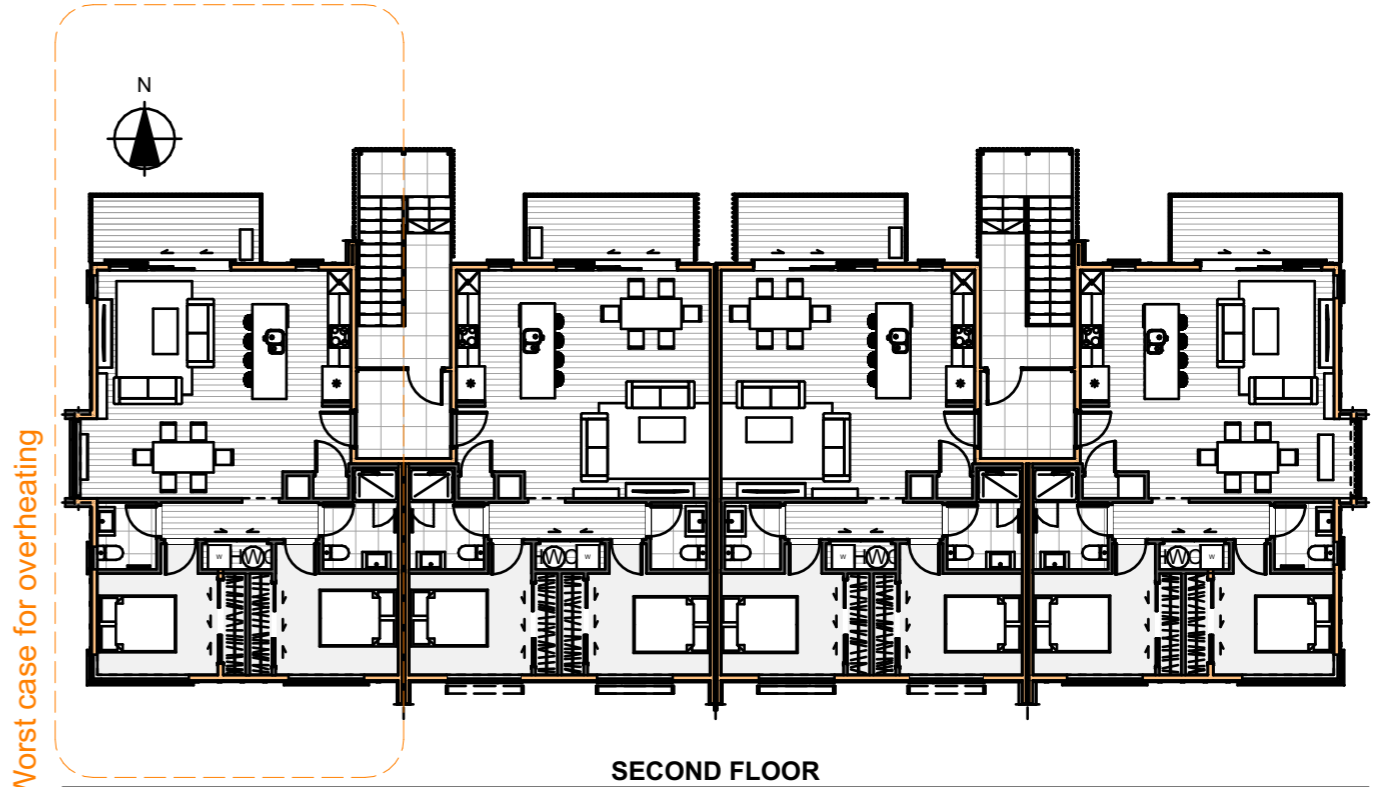

Worst case for overheating

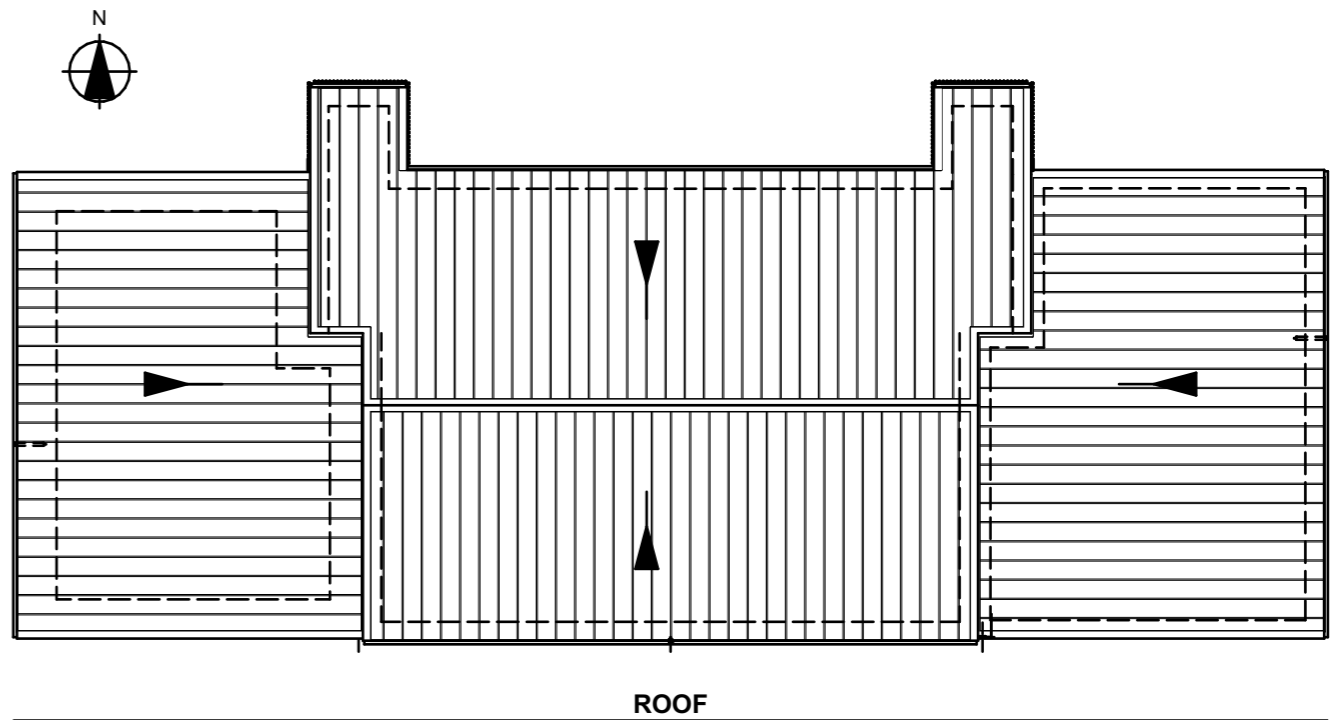
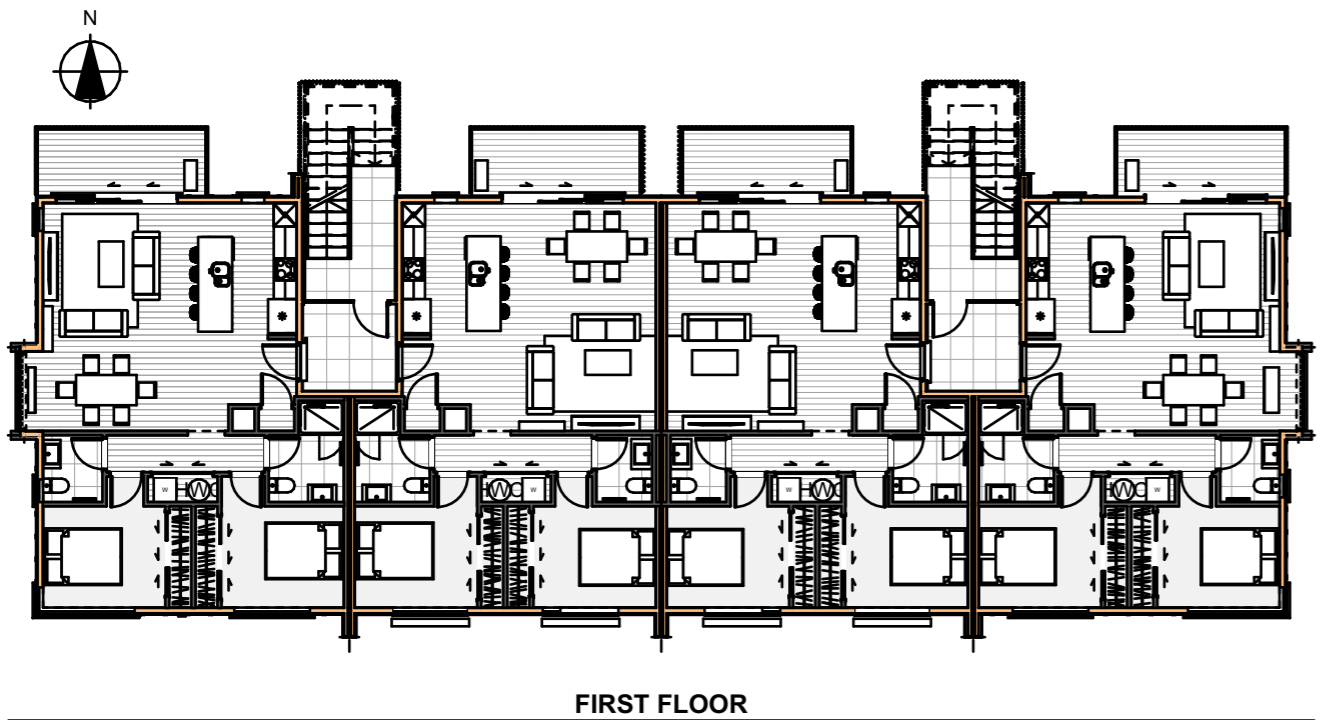

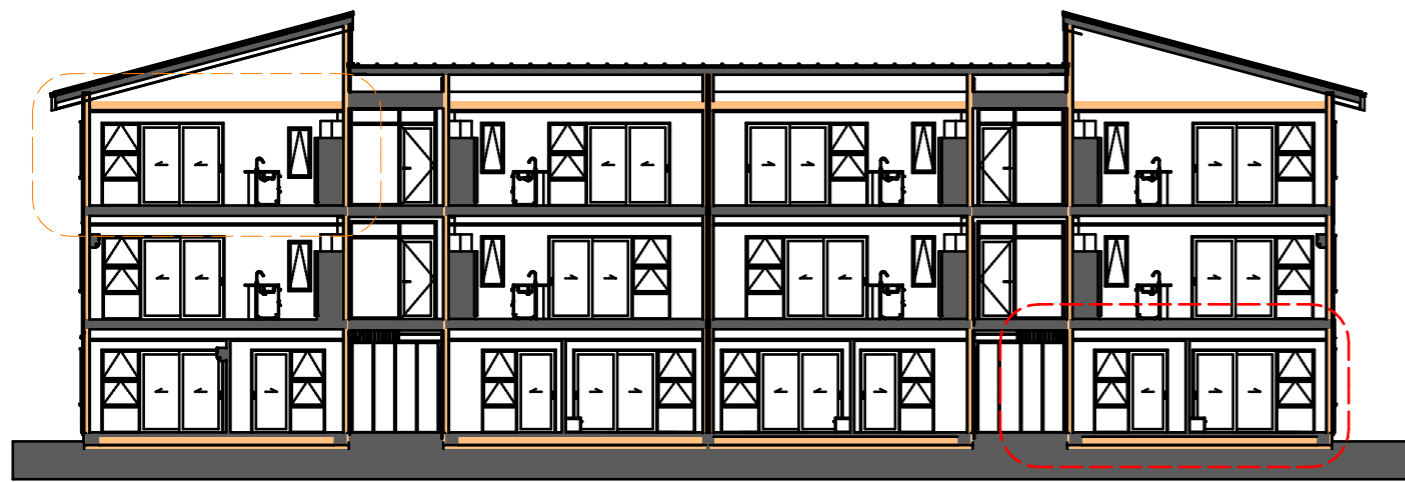

SECTION A

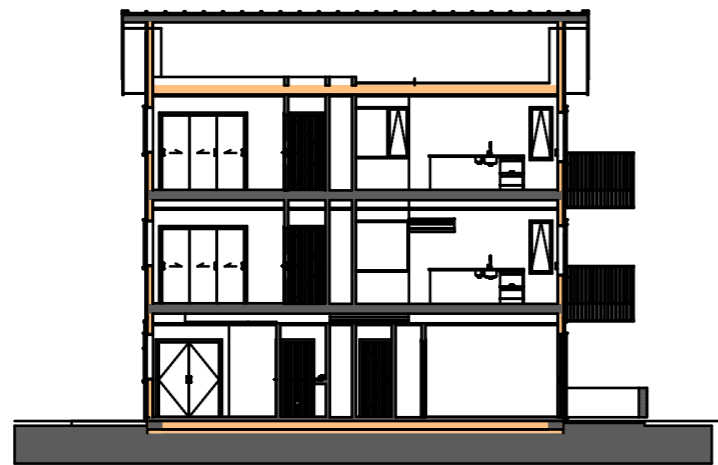

SECTION B

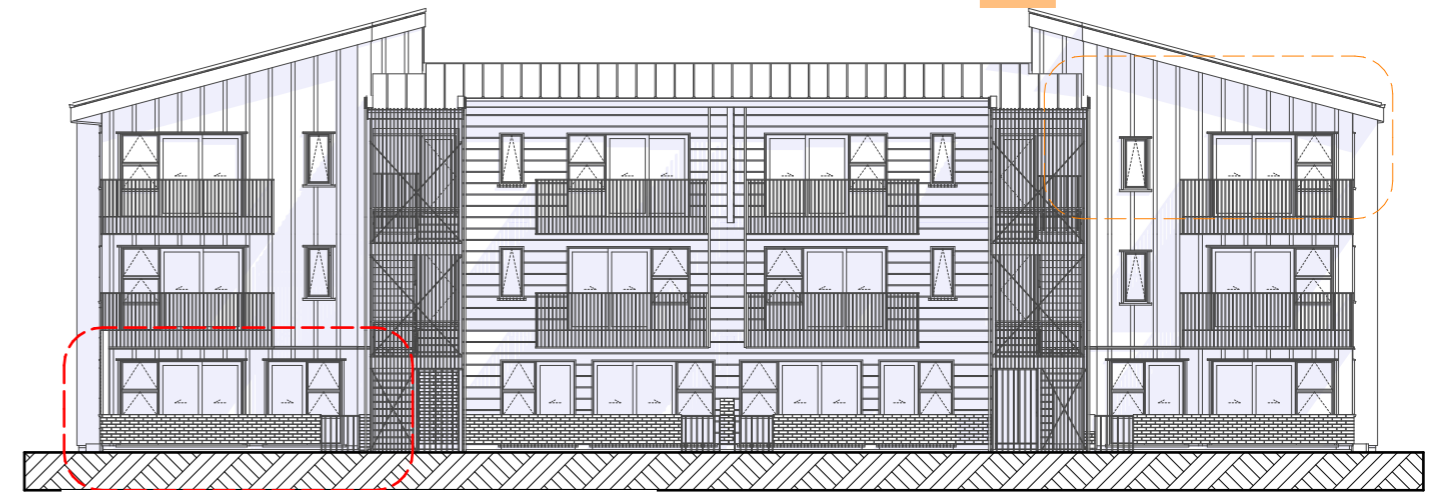

Modelled unit - worst case for heat demand

NORTH ELEVATION PROPOSED

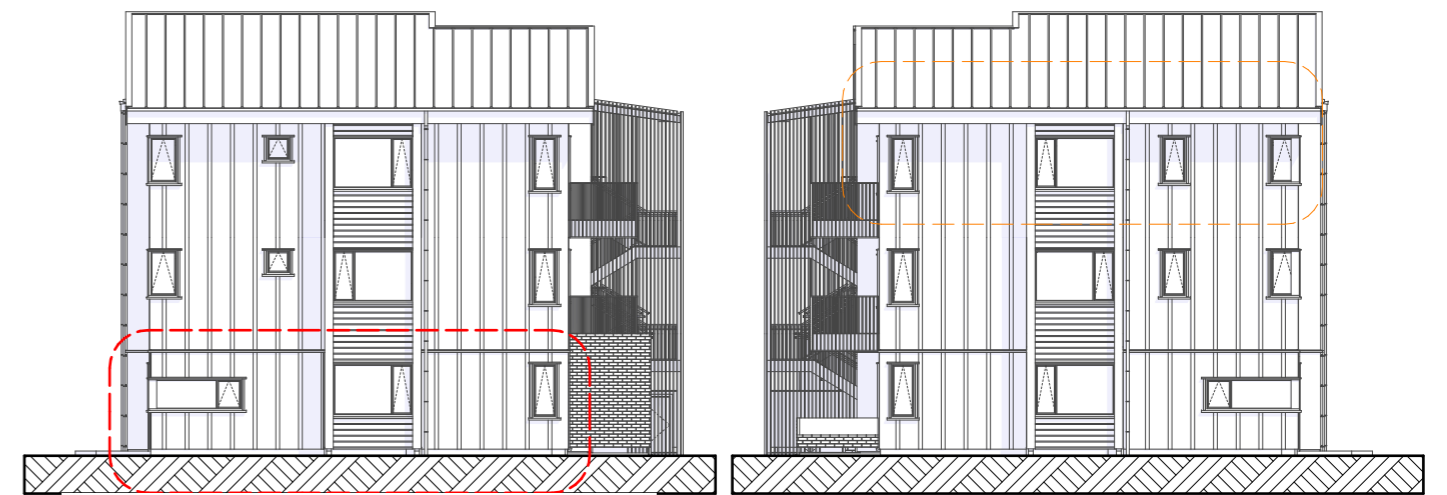

Modelled unit - worst case for heat demand

EAST ELEVATION PROPOSED

WEST ELEVATION PROPOSED



SOUTH ELEVATION PROPOSED

Modelled unit - worst case for heat demand

## Case study 4 - Specification

	AKL HS6	WLG HS6	CHCH HS6	AKL HS8	WLG HS8	CHCH HS8
Floor	FLOOR: Waffle Slab 220 solid pods with ribs and 50mm EPS under					
Wall	WALL: 90 framing (30% timber content)		WALL: 140 framing (30% timber content)	WALL: 140 framing + 45 service cavity with airtight membrane optimised (15% timber content)		
Roof	ROOF: R5.2 Rafter/Truss roof			ROOF: R6.6 Rafter/Truss roof with insulated ceiling cavity		
Thermal Bridges	ECCHO fully insulated raft slab 300 90mm timber clad		ECCHO fully insulated slab 300 140mm timber clad	HPCD 39: EWFS – 140/45 stud wall insulated waffle pod slab edge insulation and full insulation under ribs HPCH 08 EWEC External Wall - External corner 140/45 stud wall no extra timber HPCD 57 TCEA Truss Ceiling Roof Eaves - Truss roof raised heel to maintain insulation thickness		
Window frame	ECCHO Aluminium thermally broken			ECCHO Aluminium thermally broken (recessed)	ECCHO generic PVC frame (recessed)	Optimal PVC frame (supplier specific data, recessed)
Glass	L1 & L2 units: Specific double low-e argon filled glazing based on supplier's specific data (Ug = 1.1, g-value = 0.35)*	ECCHO Double Low-e Arg Best (Ug=1.30)		L1 & L2 units: Specific double low-e argon filled glazing based on supplier's specific data (Ug = 1.1, g-value = 0.35)*	ECCHO Double Low-e Arg Best (Ug=1.30)	Triple Low-e Arg Exceptional (supplier specific data, Ug=0.60, g=0.49)
	GL units: ECCHO Double Low-e Arg Best (Ug=1.30)			GL units: ECCHO Double Low-e Arg Best (Ug=1.30)		
Door panel	ECCHO Standard door					Insulated front door panel (supplier specific data)
Shading objects	Roof overhang and balcony overhang Stairs wing wall and vertical privacy screens Internal blinds on all windows					
Ventilation	Continuous extract 0% heat recovery efficiency			MVHR 82% heat recovery efficiency		
Airtightness (ACH n50)	5			2.0 with airtight membrane		1.5 with airtight membrane
Heater	50% heat pump (R32 refrigerant) 50% electric panel heater					
Hot water	100% electric HWC			100% heat pump (R744/CO2 refrigerant)		

## Case study 4 - Results

### Auckland

#### 6 Homestar

- Annual space heating demand: 35.7
- Annual electricity demand: 40.3
- Overheating without mechanical cooling: 3.2%

#### 8 Homestar

- Annual space heating demand: 19.6
- Annual electricity demand: 29.0
- Overheating without mechanical cooling: 4.9%

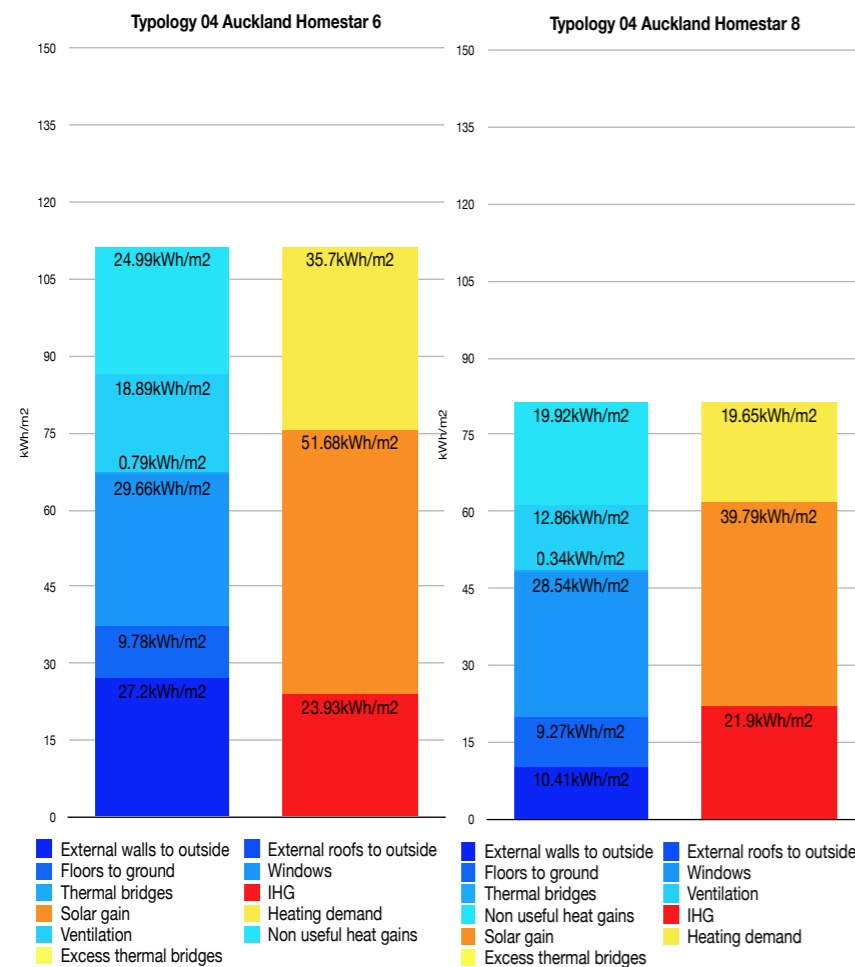

### Wellington

#### 6 Homestar

- Annual space heating demand: 59.2
- Annual electricity demand: 57.7
- Overheating without mechanical cooling: 1.0%

#### 8 Homestar

- Annual space heating demand: 23.1
- Annual electricity demand: 34.1
- Overheating without mechanical cooling: 0.7%

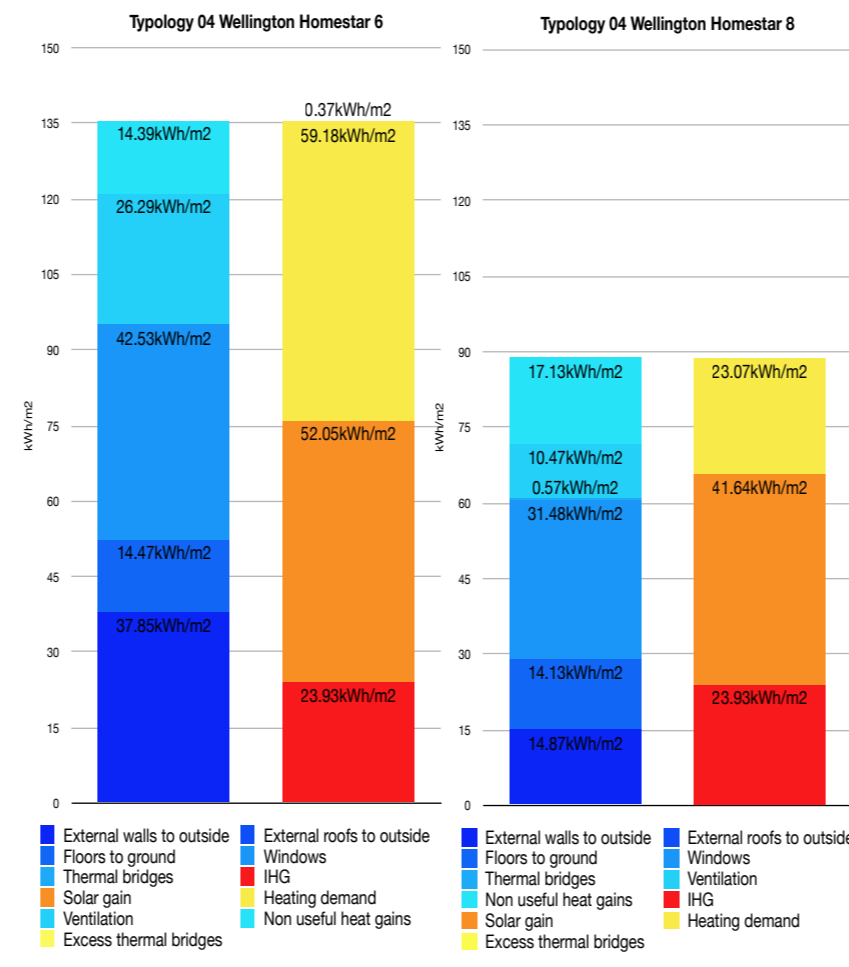

### Christchurch

#### 6 Homestar

- Annual space heating demand: 74.3
- Annual electricity demand: 69
- Overheating without mechanical cooling: 0.5%

#### 8 Homestar

- Annual space heating demand: 27.8
- Annual electricity demand: 37.9
- Overheating without mechanical cooling: 0.1%

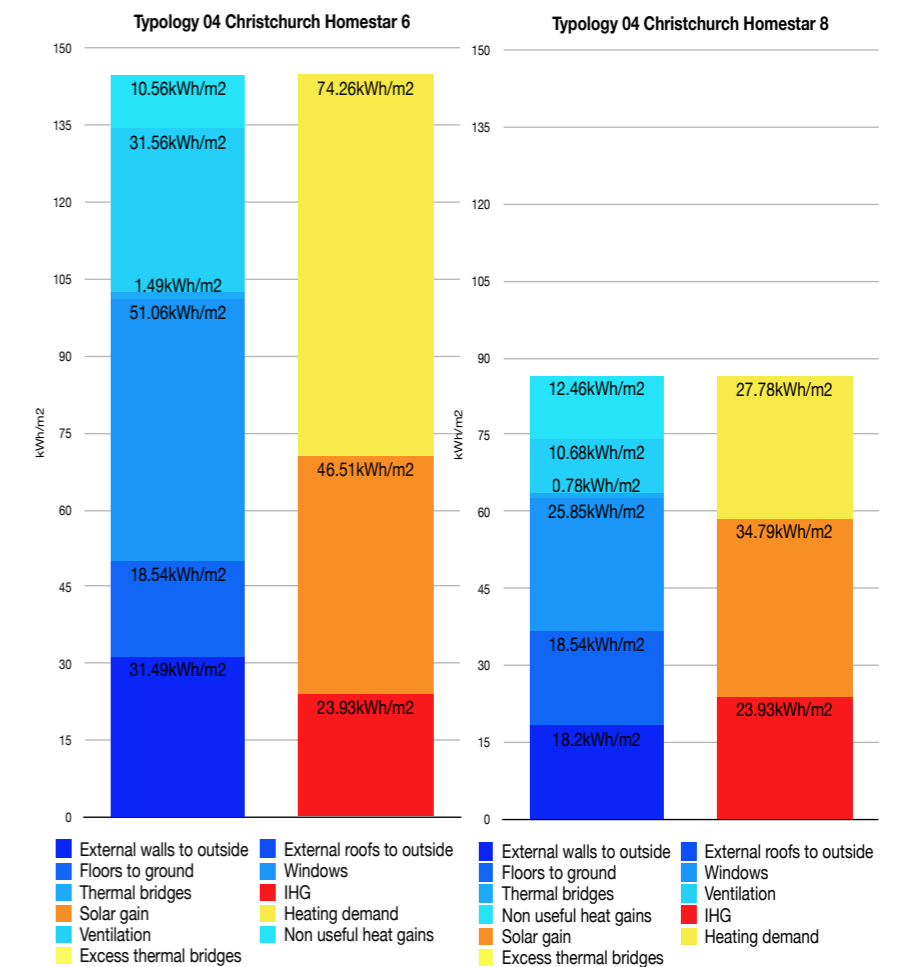



## Case study 4 - Costing (Auckland)

The following tables show the different specification upgrades needed from Building Code minimum, to achieve 6 Homestar and

8 Homestar in the three different climate zones, and the related costs for each element.

Case Study 04 - Auckland						
	Auckland					
	Building Code Minimum		Homestar 6		Homestar 8	
<b>Building total cost per m2</b>	\$4,315		\$4,395		\$4,639	
<b>Increase from Building Code minimum</b>	0.0%		1.9%		7.5%	
<b>Floor</b>	Raft slab with 220 pods and R1 edge insulation (30mm XPS with render over)	\$23,305	Additional 50mm EPS under	\$1,975	Additional 50mm EPS under	\$1,750
<b>Walls</b>	90mm framing with R2.8 insulation - 30% timber content	\$16,900	No change	-	140 framing + 45 service cavity with airtight membrane optimised (15%)	\$5,850
<b>Roof</b>	R7.0 insulation between trusses	\$2,054	R5.2 Rafter/Truss roof	\$237	R6.6 Rafter/Truss roof with insulated ceiling cavity	\$632
<b>Window frames</b>	ECCHO Aluminium thermally broken	\$13,800	+ trickle vent	\$1,800	ECCHO Aluminium thermally broken (recessed)	\$1,840
<b>Window glass</b>	Argon filled, double glazing unit. Ug=1.1	\$15,100	L1 & L2 units: Specific double low-e argon filled glazing based on supplier's specific data (Ug = 1.1, g-value = 0.35)* GL units: ECCHO Double Low-e Arg Best (Ug=1.30)	\$1,500	L1 & L2 units: Specific double low-e argon filled glazing based on supplier's specific data (Ug = 1.1, g-value = 0.35)* GL units: ECCHO Double Low-e Arg Best (Ug=1.30)	\$1,500
<b>Door panel</b>	Standard front door panel	\$1,470	No change	-	No change	-
<b>Ventilation</b>	Extractor fan in each bathroom and laundry	\$440	Continuous extract 0% heat recovery efficiency	\$800	Continuous extract 0% heat recovery efficiency	\$800
<b>Airtightness</b>	No airtight construction - assumed 5ach	\$0	No change	-	2.0 with airtight membrane	\$3,250
<b>Heater</b>	1 X 1kW electric panel heater in each bedroom and 1 X 5kW heat pump in living room (Note: this is not a code requirement but a healthy home minimum standard for rental property and reflect most new developments)	\$3,780	No change	-	No change	-
<b>Hot water</b>	Electric hot water cylinder	\$3,950	No change	-	100% heat pump (R744/CO2 refrigerant)	\$10,000
<b>Additional cost</b>	-		\$6,312		\$25,622	

Case study 4 - Costing  
(Wellington)

Case Study 04 - Wellington						
	Wellington					
	Building Code Minimum		Homestar 6		Homestar 8	
Building total cost per m2	\$4,080		\$4,138		\$4,442	
Increase from Building Code minimum	0.0%		1.4%		8.9%	
<b>Floor</b>	Raft slab with 220 pods and R1 edge insulation (30mm XPS with render over)	\$22,140	Additional 50mm EPS under	\$1,975	Additional 50mm EPS under	\$1,750
<b>Walls</b>	90mm framing with R2.8 insulation - 30% timber content	\$16,055	No change	-	140 framing + 45 service cavity with airtight membrane optimised (15%)	\$5,850
<b>Roof</b>	R7.0 insulation between trusses	\$1,951	R5.2 Rafter/Truss roof	\$237	R6.6 Rafter/Truss roof with insulated ceiling cavity	\$632
<b>Window frames</b>	ECCHO Aluminium thermally broken	\$13,110	+ trickle vent	\$1,600	ECCHO generic PVC frame (recessed)	\$4,118
<b>Window glass</b>	Argon filled, double glazing unit. Ug=1.3	\$14,345	No change	-	ECCHO Double Low-e Arg Best (Ug=1.30)	\$1,500
<b>Door panel</b>	Standard front door panel	\$1,410	No change	-	No change	-
<b>Ventilation</b>	Extractor fan in each bathroom and laundry	\$440	Continuous extract 0% heat recovery efficiency	\$800	MVHR 82% heat recovery efficiency	\$10,000
<b>Airtightness</b>	No airtight construction - assumed 5ach	\$0	No change	-	2.0 with airtight membrane	\$3,250
<b>Heater</b>	1 X 1kW electric panel heater in each bedroom and 1 X 5kW heat pump in living room (Note: this is not a code requirement but a healthy home minimum standard for rental property and reflect most new developments)	\$3,600	No change	-	No change	-
<b>Hot water</b>	Electric hot water cylinder	\$3,800	No change	-	100% heat pump (R744/CO2 refrigerant)	\$1,500
<b>Additional cost</b>	-		\$4,612		\$28,600	

Case study 4 - Costing  
(Christchurch)

Case Study 04 - Christchurch						
	Christchurch					
	Building Code Minimum		Homestar 6		Homestar 8	
Building total cost per m2	\$4,237		\$4,373		\$4,653	
Increase from Building Code minimum	0.0%		3.2%		9.8%	
<b>Floor</b>	Raft slab with 220 pods and R1 edge insulation (30mm XPS with render over)	\$22,885	Additional 50mm EPS under	\$1,975	Additional 50mm EPS under	\$1,750
<b>Walls</b>	90mm framing with R2.8 insulation	\$16,595	140 framing (30% timber content)	\$5,850	140 framing + 45 service cavity with airtight membrane optimised (15%)	\$8,450
<b>Roof</b>	R7.0 insulation between trusses	\$2,107	R5.2 Rafter/Truss roof	\$316	R6.6 Rafter/Truss roof with insulated ceiling cavity	\$711
<b>Window frames</b>	ECCHO Aluminium thermally broken	\$13,552	+ trickle vent	\$1,760	Optimal PVC frame (supplier specific data, recessed)	\$4,257
<b>Window glass</b>	Low e argon filled, double glazing unit. Ug=1.1	\$14,828	No change	-	Triple Low-e Arg Exceptional (supplier specific data, Ug=0.60, g=0.49)	\$1,840
<b>Door panel</b>	Standard front door panel	\$1,450	No change	-	Insulated door panel	\$500
<b>Ventilation</b>	Extractor fan in each bathroom and laundry	\$440	Continuous extract 0% heat recovery efficiency	\$850	MVHR 82% heat recovery efficiency	\$10,500
<b>Airtightness</b>	No airtight construction - assumed 5ach	\$0	No change	-	1.5 with airtight membrane	\$3,380
<b>Heater</b>	1 X 1kW electric panel heater in each bedroom and 1 X 5kW heat pump in living room (Note: this is not a code requirement but a healthy home minimum standard for rental property and reflect most new developments)	\$3,720	No change	-	No change	-
<b>Hot water</b>	Electric hot water cylinder	\$3,880	No change	-	100% heat pump (R744/CO2 refrigerant)	\$1,500
<b>Additional cost</b>	-		\$10,751		\$32,888	



# Moisture Control



## HC4: Moisture Control

©NZGBC 2024. NZGBC has presented the following guidance to promote better building standards and methods. The Homestar® name, logo or Homestar® rating specifications may only be used in relation to an application for or obtaining Homestar® certification. Projects that claim to meet the requirements of NZGBC rating schemes but are not certified are potentially in breach of trademark rules and may be accused of 'greenwash'.



# Moisture control

## Why focus on moisture control?

BRANZ (Building Research Association of New Zealand) [studies](#) have shown that around 40% of existing New Zealand homes they studied (many of them older building stock) are mouldy, causing ongoing health and durability issues. Mould forms where the conditions are right – primarily where there is moisture.

In our buildings, this will be where surfaces get cold enough for high moisture levels to form, both on the surface and within the construction. To reduce the risk of this, we must prevent moisture getting into the building fabric while also allowing any that is there to escape.

Homestar credit HC4: Moisture Control addresses the need to account for this in our building.

The [thermal envelope](#) is made up of all elements that sit between the interior environment and the exterior – walls, floors, roofs, windows, doors, ducts, and pipes to the exterior. For the insulation to be effective it needs to be continuous.

## Thermal bridging

The thermal envelope is made up of all elements that sit between the interior environment and the exterior – walls, floors, roofs, windows, doors, ducts and pipes to the exterior. For the insulation to be effective it needs to be continuous. However, in construction it can often be 'bridged' by materials or junctions in the envelope which transfer heat to a greater extent than the surrounding elements.

Thermal bridging can take several forms. In Homestar we deal with [repeating](#), [linear](#) and [geometric thermal bridges](#).

**Repeating thermal bridges** – where there are regular interruptions in the insulation layer such as studs or wall ties. This thermal bridge is included in the [R-value calculation](#) for an assembly

**Linear (non-repeating) thermal bridges** – where there are gaps in the insulation layer such as around windows or doors or where a more conductive material penetrates or bridges through the insulation layer. This thermal bridge is accounted for in ECCHO by the use of psi values.

**Geometric thermal bridges** – junctions between two or three different building elements (such as corners), where the heat loss area is greater than assumed from the internal surface area

Other thermal bridges include **point bridges**. These are ignored in Homestar since they are less significant.

Thermal bridges can account for a relatively small amount (around 5%) of a building's heat loss. Avoiding condensation and mould risk is essential to ensure the health of the interior, and the durability of the building fabric, so this is the primary concern.

To know when the thermal bridge is no longer a concern a thermal bridge model is required, to give us two different numbers, the psi value and the fRsi value.

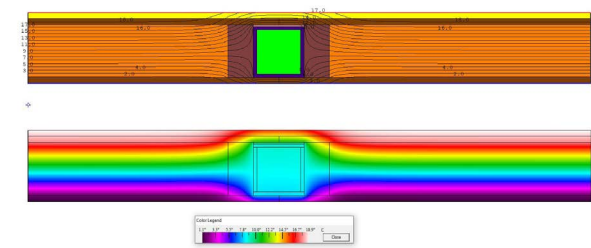
 An uninsulated steel column in a wall, showing heat loss, and cold surface temperatures

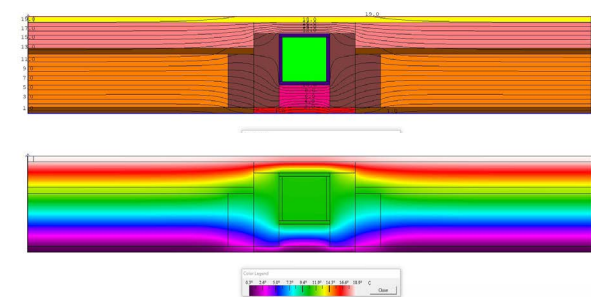
 A steel column in a wall with insulation and a thermal break (in pink) showing far less heat loss, and higher internal surface temperatures

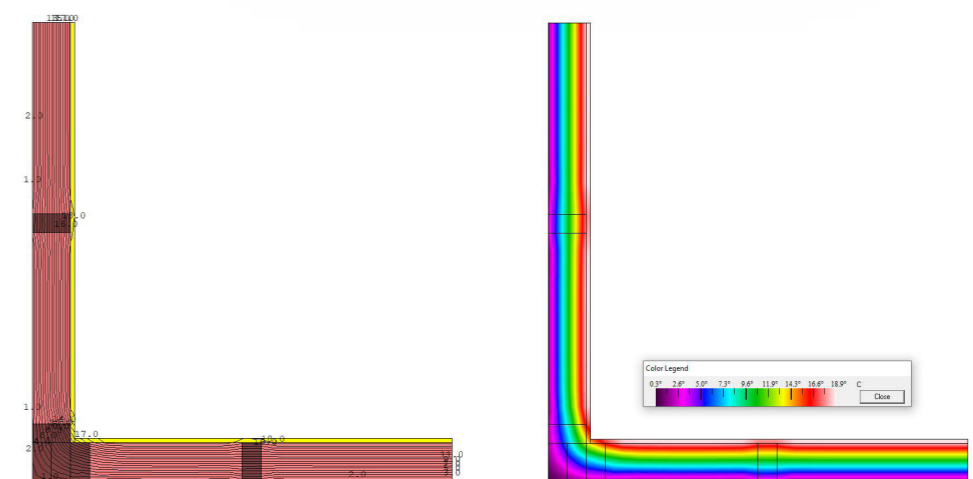
 An exterior corner with a traditional 3 stud corner, showing how the interior surface temperature is impacted by the amount of timber present in the junction

# Moisture control (cont.)

## The psi value

Linear thermal transmittance, or psi value, is a measurable correction value that allows us to quantify the heat loss through a junction and include this in our thermal model. This is used in many modelling software packages.

In ECCHO we use external dimensions. We do this to make an allowance for additional heat loss through all of the junctions in the home (for example between a wall and a floor). The psi value then corrects this allowance based on a more accurate two-dimensional model of the junction.

Sometimes the original allowance overestimates the heat loss (in which case the psi value will be negative and remove heat from the model). More commonly it's positive because the original allowance underestimated the heat loss through the junction.

## The fRsi

The surface temperature factor, or fRsi, is the difference between the interior surface temperature and the exterior air temperature, divided by the average temperature difference between interior and exterior. It is a dimensionless value which helps us assess condensation and mould risk. The factor will be between 1 and 0. Although both are impossible, the lower it is, the greater the chance of condensation and mould growth. The best junctions are closer to 1.

The fRsi value needed for a given junction to avoid condensation is dependent on moisture generation rates, ventilation, and internal temperature. Homestar sets fixed target fRsi values based on typical conditions. Higher fRsi values may be necessary in some situations, such as where high moisture rates are anticipated, for example through high occupancy levels.

## 2D and 3D thermal bridges

Thermal bridges are either 'linear' or 2D, where the correction factor is calculated by measuring the slab perimeter, or the length of wall where it meets the roof. However, there are also point, or 3D thermal bridges - for example metal screws fixing through a warm roof system, or reinforcing bars bridging a thermal break. These are more complex to model and are outside the scope of this guide, as they are not required to be assessed in Homestar at this stage.

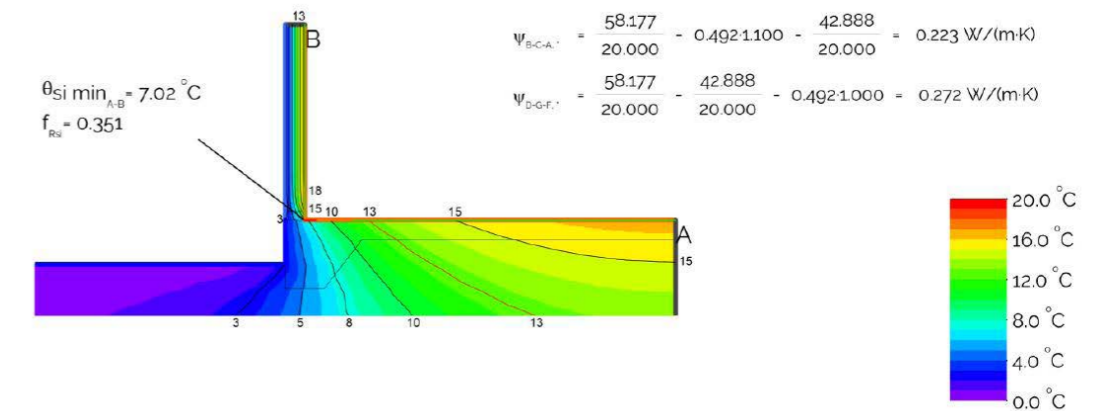

A thermal bridge model showing the lowest interior temperature, which is 7.02 degrees C, and the fRsi value, which is 0.351. This junction will likely result in condensation and mould.

## How to use the High Performance Construction Details Handbook

Passive House Institute New Zealand (PHINZ) and BRANZ worked with Jason Quinn from Sustainable Engineering Ltd to produce the Performance Construction Details Handbook (HPCDH), a document that covers a wide range of typical thermal bridges, assemblies and build-ups used in New Zealand.

In Homestar it is a mandatory minimum to include the slab edge thermal bridge in the ECCHO model. Rather than having to produce a thermal bridge model every time, you can refer to the HPCDH for the relevant psi value ( $\Psi$ ) and  $f_{Rsi}$ , by sourcing the detail and using the figures highlighted to the right.

A reference document on thermal bridges is available on the [Homestar Technical Resources page](#). If there is no detail sufficiently similar, a thermal bridge model will be required. A list of consultants is available there.

We can then take the psi number under the exterior reference area (because we measure externally in Homestar and PHPP) and include it in ECCHO. We also check the  $f_{Rsi}$  factor for the detail (0.580 in this case).

### Edit Thermal Bridge

Save and close

Description: HPCD 30: EWFS - 90mm stud current ...

Group: Ground perimeter thermal bridge

Qty (#): 1.0

Length (m): 22.8

Psi value: -0.317

## Junction

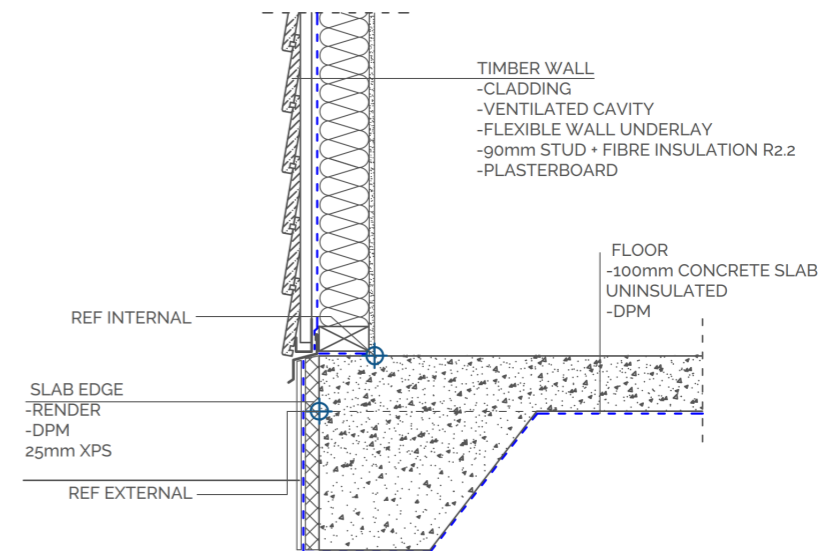

### 30 EWFS External Wall to Floor Slab - Stud wall 90mm stud current practice un-insulated slab edge insulation only

#### RESULTS TABLE

$\Psi$	EXTERIOR REFERENCE AREA (PH)	INTERNAL REFERENCE AREA
	0.317 W/(mK)	-0.268 W/(mK)
$f_{Rsi}$	0.580	
Cost	\$226 per linear metre	
Carbon	65 kgCO <sub>2</sub> eq/m	
Carbon Storage	5 kgCO <sub>2</sub> eq/m	

This detail represents a typical current practice slab with added edge insulation and no insulation below the concrete slab, with a current practice 90mm timber stud wall. This small amount of insulation significantly lowers the slab heat loss and increases the  $f_{Rsi}$  to above the 0.55 required by PHI for warm climates like Auckland.

## Where can thermal bridges occur?

Thermal bridges are commonly found at junctions in the building envelope. A simple way to find them is to take a plan, section or detail and draw a red line through the insulation. If there is a break in this line at any point this will be a thermal bridge.

### Timber Construction

In timber construction there is less of a concern as long as the amount of timber in each place is minimised. Insulation has a thermal conductivity of around 0.035, whereas timber framing has a thermal conductivity of around 0.13 - around 271% worse. Concrete has a thermal conductivity of 2.1 so nearly 600 times worse, and steel has a thermal conductivity of 50 so nearly 15,000 times worse!

The main areas to consider will be the floor to wall, mid-floor to wall and wall to roof junctions, minimising the amount of timber and ensuring the continuity of the insulation at each junction. Other areas to be aware of are concrete slab edges and thickenings or ribs in the slab, window and door installation details, plumbing vent pipes and other areas where the insulation is bridged.

- ☑ Suspended timber floors make achieving thermal performance easier than concrete as there is minimal thermal bridging to deal with.
- ☑ Warm roofs may be easier to achieve airtightness and continuous insulation, while also avoiding issues around cold roof voids. However, they also increase the heat loss area without adding much usable floor area.
- ☑ Suspended floors require a ground vapour barrier beneath - a polythene sheet placed on the ground under buildings to prevent moisture rising from the ground and affecting the building.

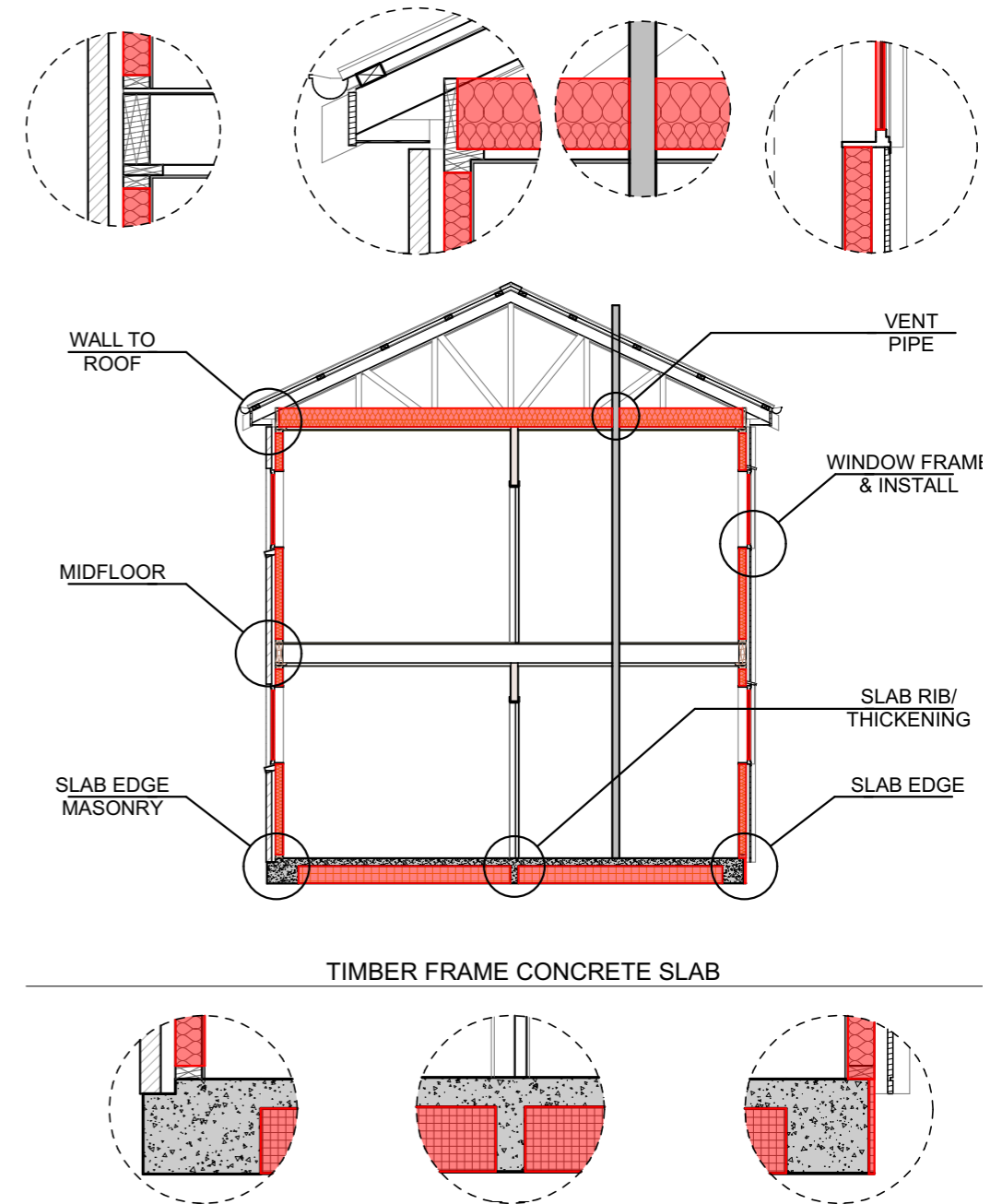



## Where can thermal bridges occur? (cont.)

### Concrete construction

In concrete construction there is far more likelihood of thermal bridges occurring. Insulating concrete internally has significant risk for interstitial condensation and mould. This is due to the concrete being 'cold' and in contact with exterior air. If any of the warm, moist interior air gets through the insulation, then condensation will form, which has a high likelihood of forming mould.

Insulating internally like this also results in significant thermal bridges at the mid-floor and slab edge.

A much more effective approach is to insulate the concrete externally. In this case the concrete is all kept 'warm', so reducing condensation risk, and also providing thermal mass internally. Insulation can then be installed continuously over the exterior of the concrete and under the slab, and the joinery can be installed in line with the exterior insulation.

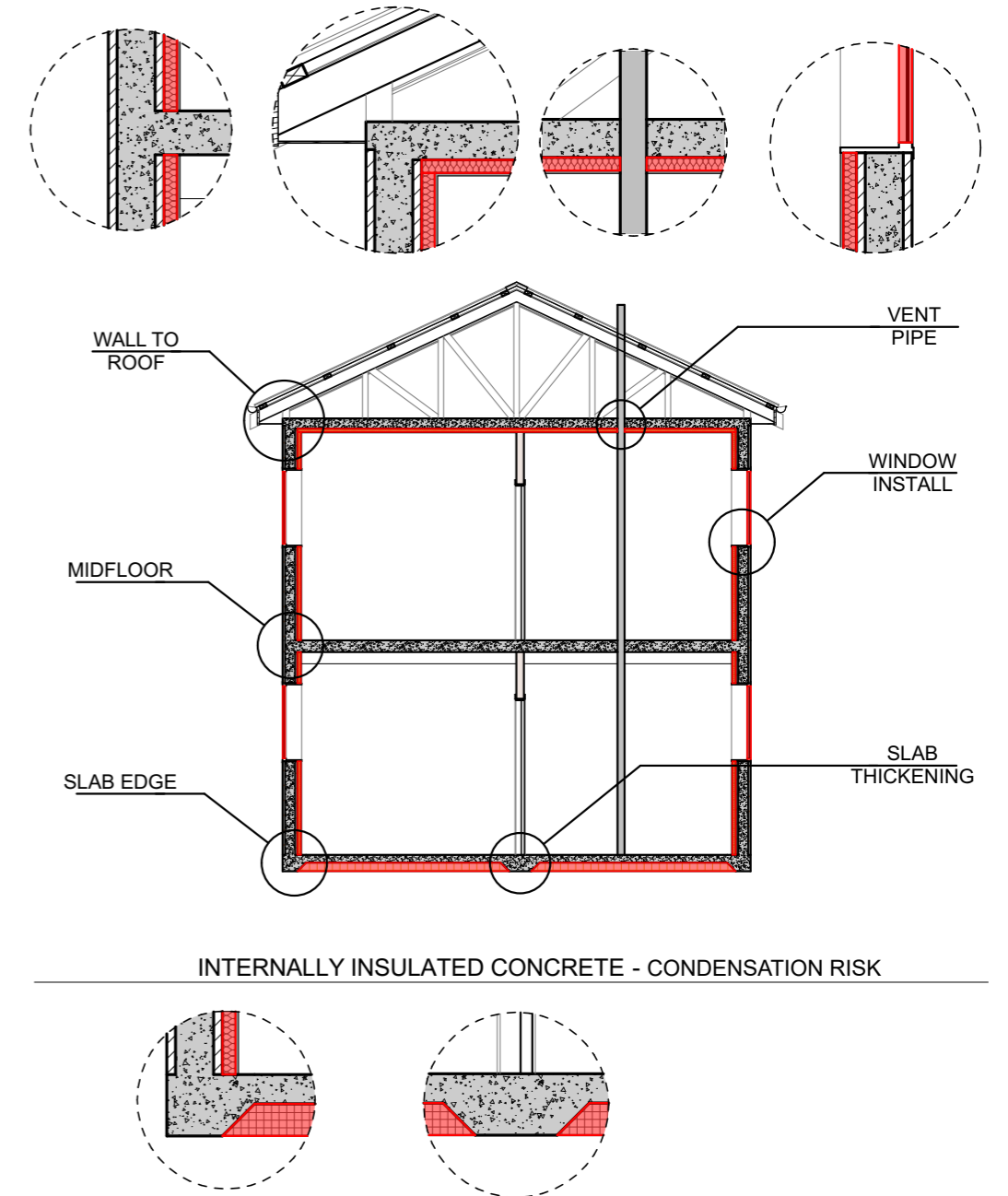

## Slab edge thermal bridges

In Homestar it is a mandatory minimum requirement to include the slab edge thermal bridge in the ECCHO model. Many standard slab edge details are already included in the High Performance Construction Details Handbook (HPCDH), so the data for these can be included:

- ✔ Navigate to the HPCDH and find the slab edge thermal bridge closest to your detail
- ✔ If there isn't an exact match, in many cases it is acceptable to utilise the values for a detail that is worse - e.g. your detail includes 20mm edge insulation, whereas the closest one in the HPCDH includes 10mm. As the fRsi (mould risk factor) and psi value (heat loss) of your own detail will be better, it is acceptable to include this as conservative values.
- ✔ If there is no detail similar enough then you will need to engage a consultant to produce a thermal bridge model.
- ✔ If you are using a suspended timber floor still include the data from the relevant detail in the HPCDH

## Options to insulate slab edges and connections

To achieve the required fRsi it will be necessary to insulate the edges of your slab, and in most climates you will also need to include under slab insulation.

To manage the slab edge there are a range of options:

Option 01 - overhang the bottom plate over the insulation

Option 02 - run the insulation over the face of the slab edge and bottom plate

Option 03 - insulate on top of the slab

Option 04 - proprietary edge insulation products

The relevance of these options will depend on the project and individual scenario, and may require engineering input for bottom plate overhangs for some custom details such as option 01.

In pod systems, due to the ribs bypassing the insulation pods, they do not have any significant thermal performance increase on the slab, so only slabs with insulation beneath the ribs are considered to be fully insulated.

## Steel connections to slabs

Where steel portals and columns connect to slabs, consideration needs to be paid to whether the slab and steel are 'both cold', 'both warm', or whether one is cold and one is warm. In this situation structural thermal break pads can be included to thermally separate the concrete and steel.

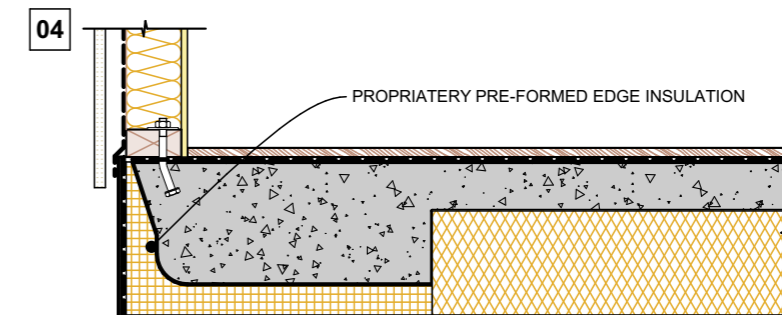
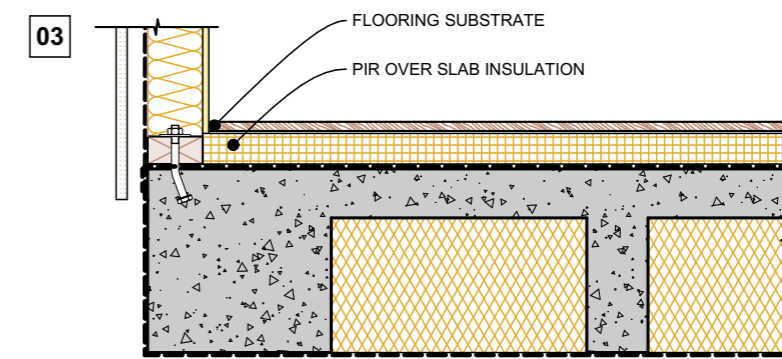
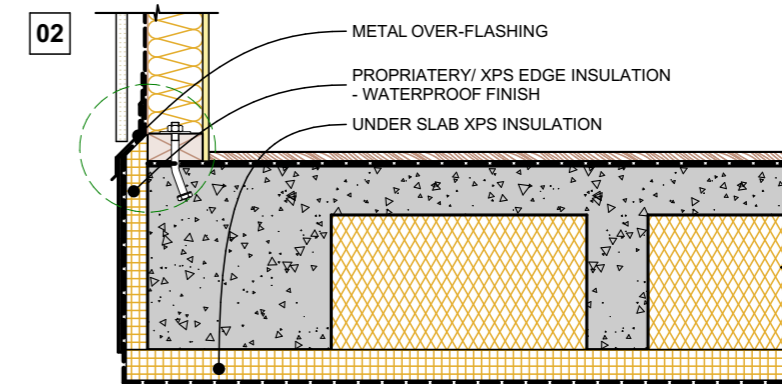
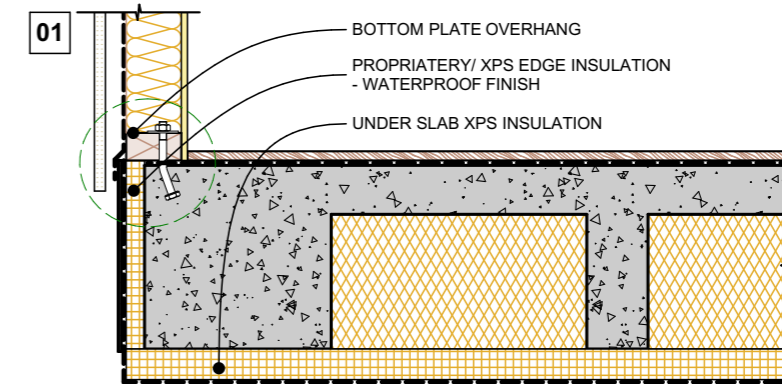

## Footings for masonry cladding and wing walls

Where a design requires a projecting footing to support a wing wall or masonry cladding, the slab must be thermally broken. Two options to achieve this are:

- Thermally decoupling the two parts of the slab, by including XPS insulation between them and structurally tying them together with glass fibre reinforcement bars
- Insulating on top of the slab to keep all of the slab and footings 'cold'.

Glass fibre reinforcing bars (GFRP), while not yet common, are available in New Zealand. They have a very low thermal conductivity, while still meeting the structural requirements. If they were not used then steel reinforcing bars would be bypassing the thermal break, resulting in a number of point-thermal bridges, and reducing performance. At lower star levels this may not be an issue, but they may need to be considered at higher star levels where the performance requirements are more stringent.

Option 01 - overhang the bottom plate over the insulation

Option 02 - run the insulation over the face of the slab edge and bottom plate

Option 03 - insulate on top of the slab.

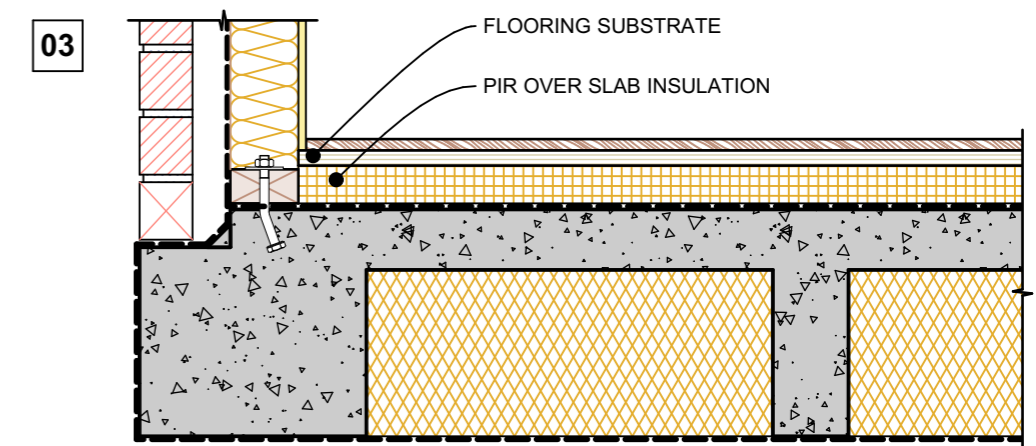
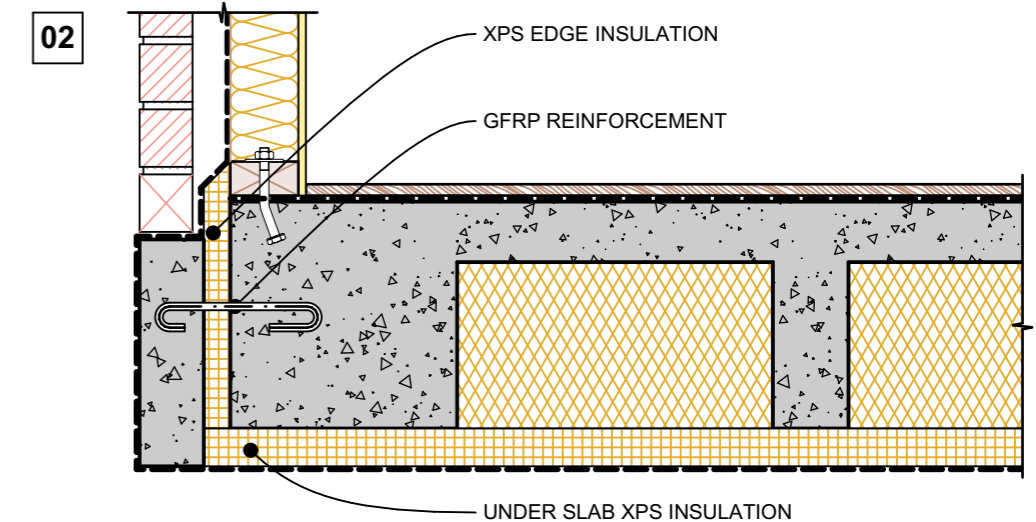
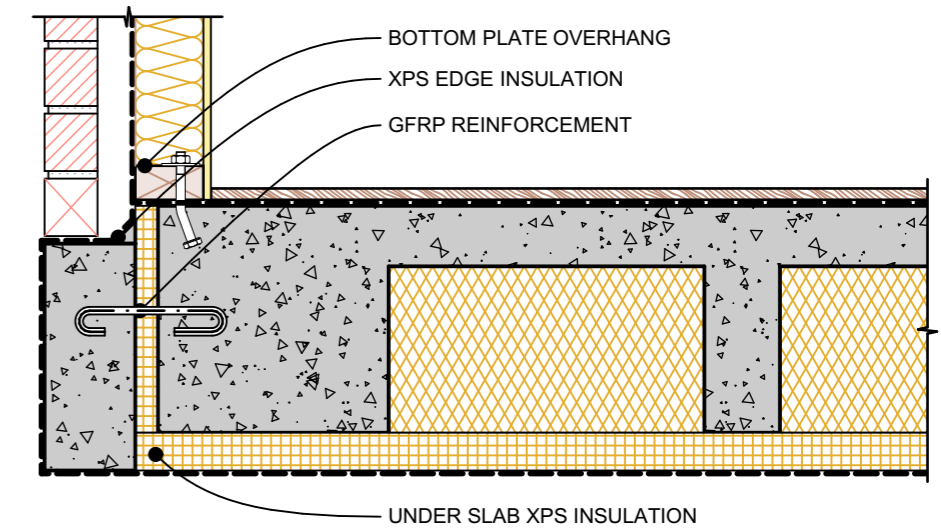

## Slab junctions between conditioned and unconditioned spaces

Where a design includes a location where a concrete floor slab bridges a treated and an untreated space, such as a garage, the junction between these two spaces must be thermally broken to avoid heat transfer, and condensation potential.

In these situations the slab must be thermally broken. Two options to achieve this are:

- ✔ Thermally decoupling the two parts of the slab, by including XPS insulation between them and structurally tying them together with glass fibre reinforcement bars
- ✔ Insulating on top of the slab to keep all of the slab and footings 'cold'.

As noted on the masonry footing details, GFRP bars, while not yet common, are available in New Zealand.

NB in waffle pod floors the pods do not act as insulation, as the ribs bridge this layer sufficiently to make their impact negligible.

Option 01 - overhang the bottom plate over the insulation

Option 02 - run the insulation over the face of the slab edge and bottom plate

Option 03 - insulate on top of the slab, enabling the slab connection to remain the same.

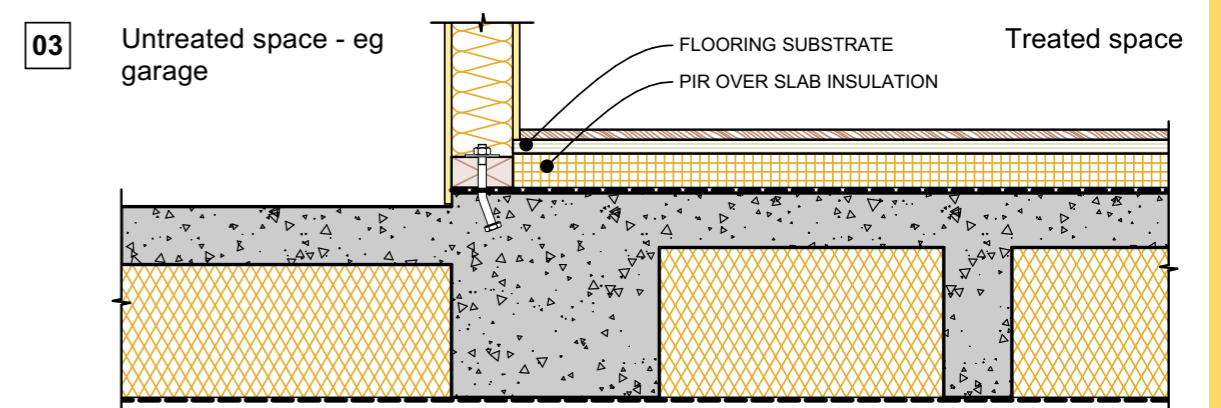
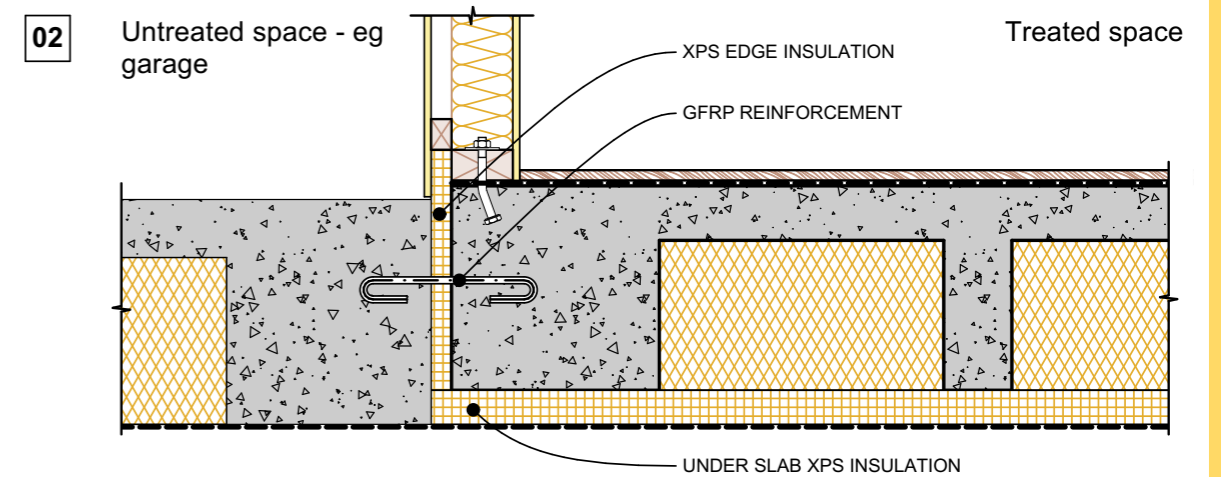
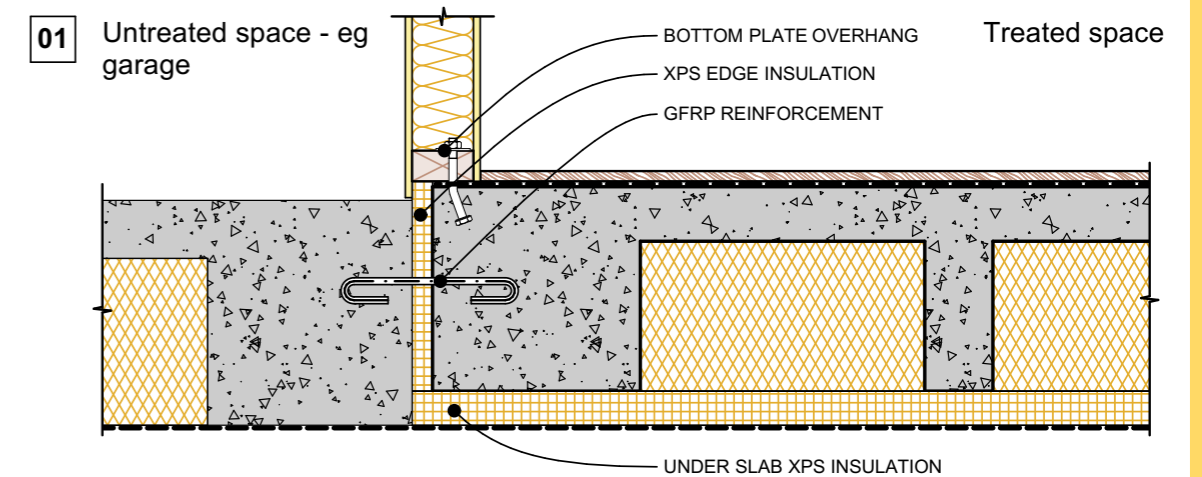



## Steel columns, portals and beams

Steel is a highly thermally conductive material, and there can be significant heat loss and condensation risks if the material is allowed to bridge the thermal envelope.

Any use of steel should be considered as early as possible as inclusion of the material will have implications for the whole building envelope. In a typical project, it may be common practice for a lintel or other element to be added to a design for structural requirements. If the wall thickness has already been determined, this may cause issues where thermal bridging also needs to be considered.

- ✔ The thermal resistance and transmittance calculation in ECCHO uses the methodology of ISO 6946 and this is limited by the magnitude of difference in thermal conductivity of materials. As a result, ECCHO cannot be used to calculate the thermal performance or steel frame construction and alternative software or calculation methodology must be used
- ✔ In a practical sense, including thin thermal breaks over steel frames will rarely achieve the required fRsi of Homestar. Therefore continuous external insulation should be specified for steel frame designs.
- ✔ Similarly, if steel columns and beams are being implemented in conjunction with timber framing, careful attention must be paid to prevent thermal bridging. A thermal bridge model must be used to calculate the Psi value to assess heat loss and the fRsi factor to assess condensation and mould risk
- ✔ As well as the individual elements, their connections to other building elements must be considered, to assess whether any heat transfer or condensation risk will occur - where a steel column meets a cold concrete slab for example.

There are several recommended methods for dealing with steelwork:

- ✔ Option 01 - Keep the steel all 'warm' and inside the thermal envelope, by insulating between it and the exterior air and preventing any connections to 'cold' elements.\*
- ✔ Option 02 - Keep the steel all 'cold' and outside the thermal envelope, by insulating inside it. In this case steps must be taken to prevent moisture getting to the steel as it will condense and result in potential durability issues. This can be achieved by installing a thermal break and a vapour control layer around the steelwork. Hygrothermal modelling may be required.

**\*A note about balconies. A good solution for balconies and external access for high performance buildings is to design a self-supporting structure that is placed externally to the building envelope. This can eliminate the need for structural thermally broken penetrations. Aesthetic and access implications of this solution are among the reasons why this needs to be considered as early as possible.**

- ✔ Option 03 - Install a structural thermal break to prevent bridging. This could be between a concrete slab and a steel column, or thermally breaking a beam that is bridging an exterior wall for example. Some proprietary solutions for structural thermal breaks are available in New Zealand, and any solution will likely require structural engineering input.

Due to the requirement for a minimum 15mm thermal break over any steelwork, it is unlikely to fit within a 90mm stud wall, so either a 140mm stud or internal packing will be required to accommodate the additional insulation. This should be considered early in the design.

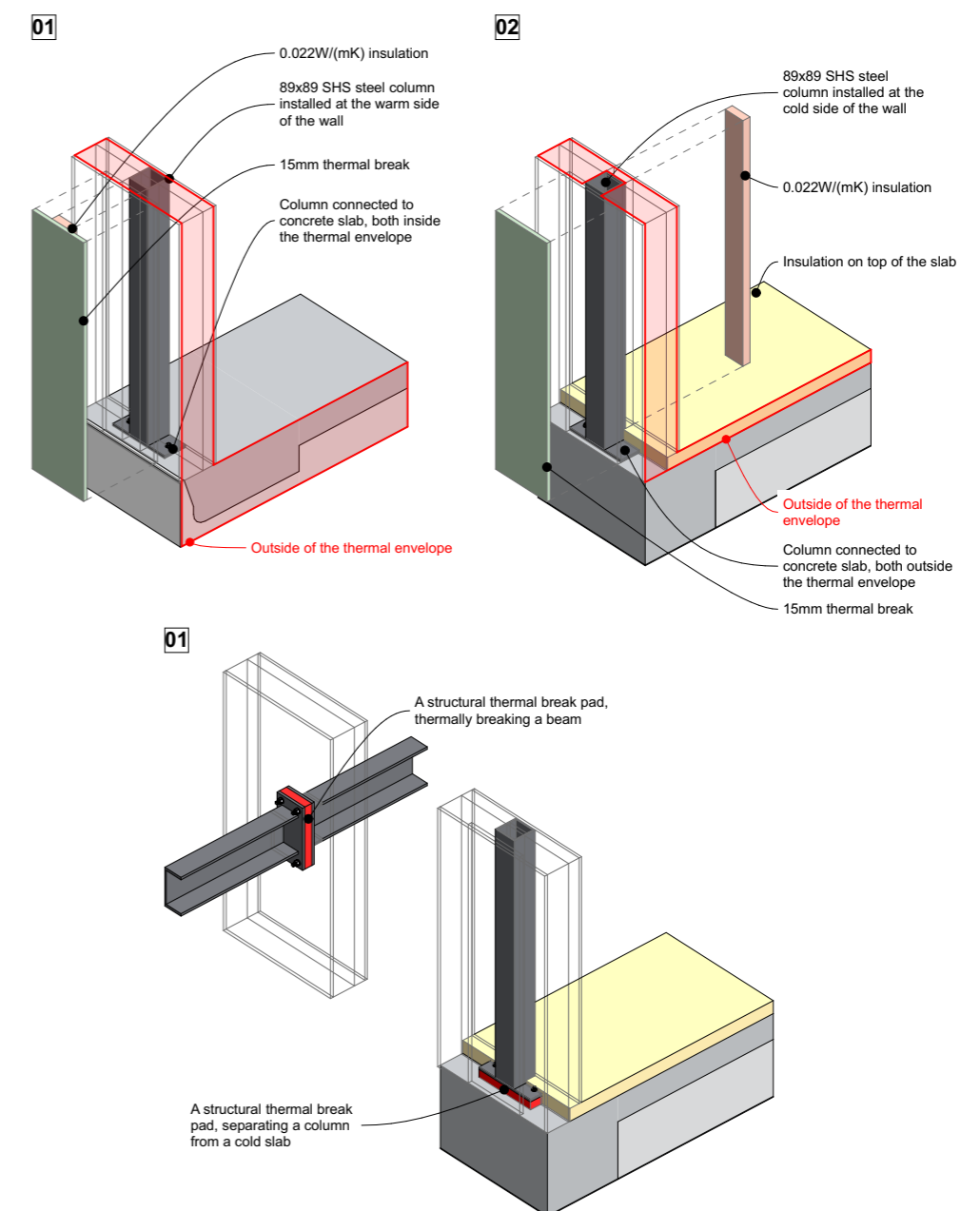

## Roof perimeter insulation

With some truss roof designs with insulation at the ceiling level, the space where the truss meets the wall can be very tight. This can mean correctly installing thicker amounts of insulation can be challenging while also ensuring the 25mm air gap between insulation and building paper/ purlin.

Under the H1/AS1 5th edition schedule method, the below exemption is compliant:

In roofs with a roof space, where the insulation is installed over a horizontal ceiling, the roof R-value may be reduced to R3.3 for a distance of up to 500 mm from the outer edge of the ceiling perimeter where space restrictions do not allow full-thickness insulation to be installed.

While this may be accepted, it is not recommended. Alternative details are available that allow higher levels of continuous insulation in the corner.

Two potential approaches are shown to the right:

- ☑ Increase the ceiling cavity by 55mm and add insulation within to overlap the thinner area of insulation (HPCDH detail 59). This may be a good approach should the height of the building be set, while losing minimal internal height.
- ☑ Increase the truss heel height to accommodate the extra insulation thickness (HPCDH detail 60). While this may increase the height of the building (170mm in this example) with potential HIRB (height in relation to boundary) impacts, this could be minimal if allowed for early in the concept design.

Frame manufacturers are becoming better at identifying thermal bridging and opportunities for increasing insulation. Alternatively, consider installing a warm roof.

H1/AS1 5th Addition - compliant ceiling insulation exemption

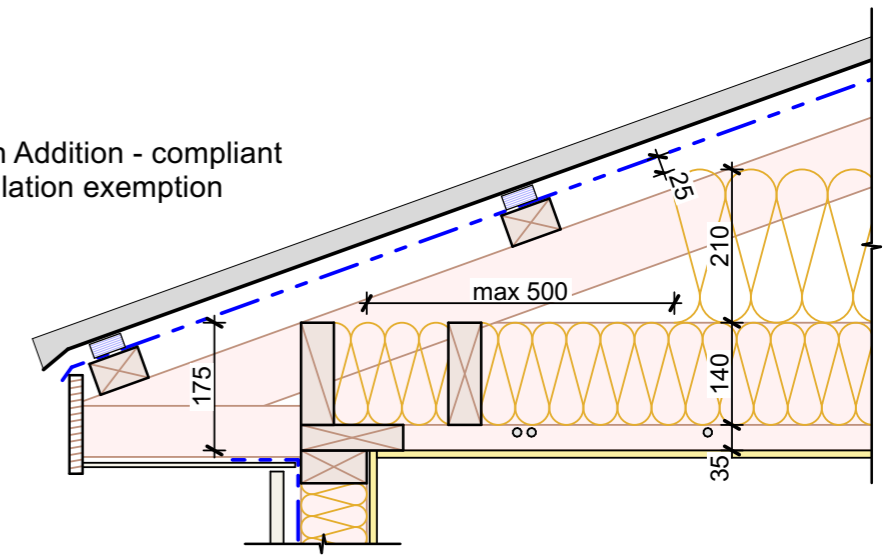

HPCDH 59 - Increase ceiling cavity by 55mm to 90mm and insulate - ensure overlap of top & bottom insulation

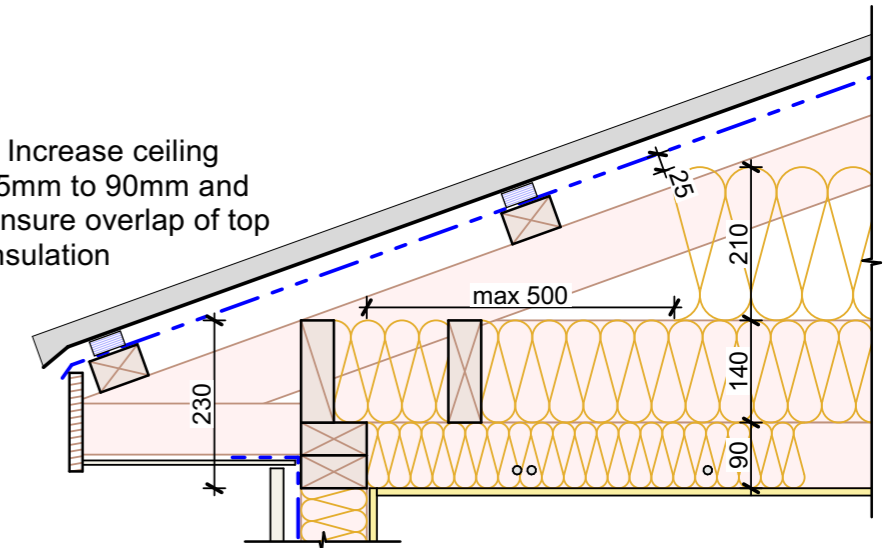

HPCDH 60 - Increase truss heel height to accommodate increased insulation thickness

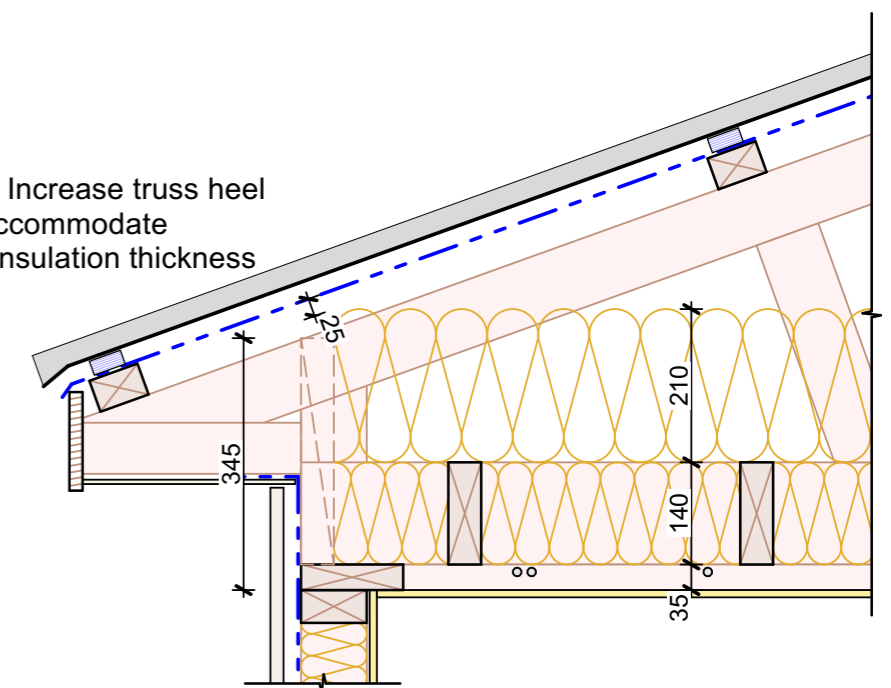

## Airtightness

Historically our buildings were very air leaky. They had gaps everywhere you could think of, for example through plug sockets, light fittings, behind skirtings, etc. Although this was a problem for comfort and energy use (letting cold draughts in) it was less of a problem for mould since these older homes typically had no (or little) insulation inside the wall, so the outer layers of the wall remained warm. This reduced the likelihood of moist air reaching high enough relative humidity levels for mould and/or moisture from the air condensing.

With increasing levels of insulation in our walls, the outer layers of the wall on the cold side of the insulation get colder. If there are gaps in the layers of a wall then warm, moist air from inside will move to the colder outer layers. When this air gets to a low enough temperature, the moisture will then begin to condense on any surface cold enough – studs, bottom plates, the back of the WRB.

This will cause durability issues due to the potential for rot in many materials, but will also create the ideal conditions for mould. If the moisture condenses within your insulation it could slump and sag within the wall due to the extra weight, and suddenly you have a gap in your thermal envelope, resulting in further heat loss.

To reduce the likelihood of this happening the solution is to make the fabric of your building as airtight as you can. The main airtightness layer should ideally be on the warm side of the insulation in 'warming climates' which includes all New Zealand climate zones, to prevent moist air from getting to the colder side of the insulation.

Making a home airtight doesn't mean you can't open windows and doors – their purpose is to be openable (but when they're closed they should be airtight). Airtightness simply means that you are preventing unintended air leaks in the building fabric.

### How to measure it?

Airtightness can be measured in two different ways:

- ✦ Air change rate n50 from ISO9972 which measures 'air changes per hour' - how much of the air leaks out using the net air volume of the building when it is pressurised to 50pa (50 pascals)
- ✦ Air permeability qE50 from ISO9972 which uses the envelope area as a reference for airtightness, and measures how many cubic metres of air leaks out per square metre of envelope per hour at 50pa.

Frame manufacturers are becoming better at identifying thermal bridging and opportunities for increasing insulation. Alternatively, consider installing a warm roof.

Homestar uses air permeability, with mandatory testing for 8 star and up.

A blower door test is required to measure airtightness. This is when a large fan is strapped into one of the doors or windows, which then pressurises and de-pressurises the building and measures the air flow. It does both as windows will perform differently when pushed onto, and pulled away from their seals for example.

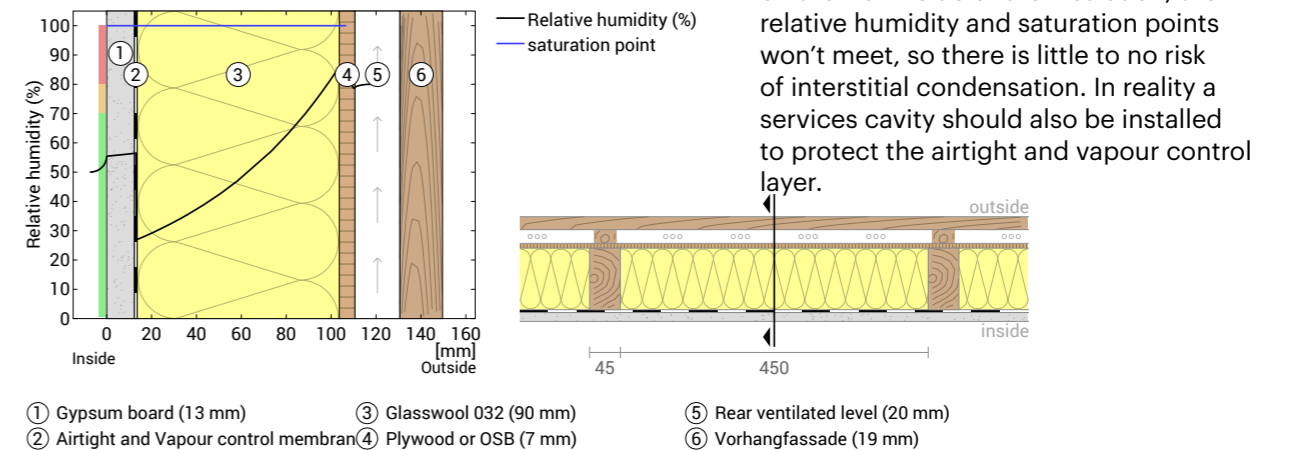
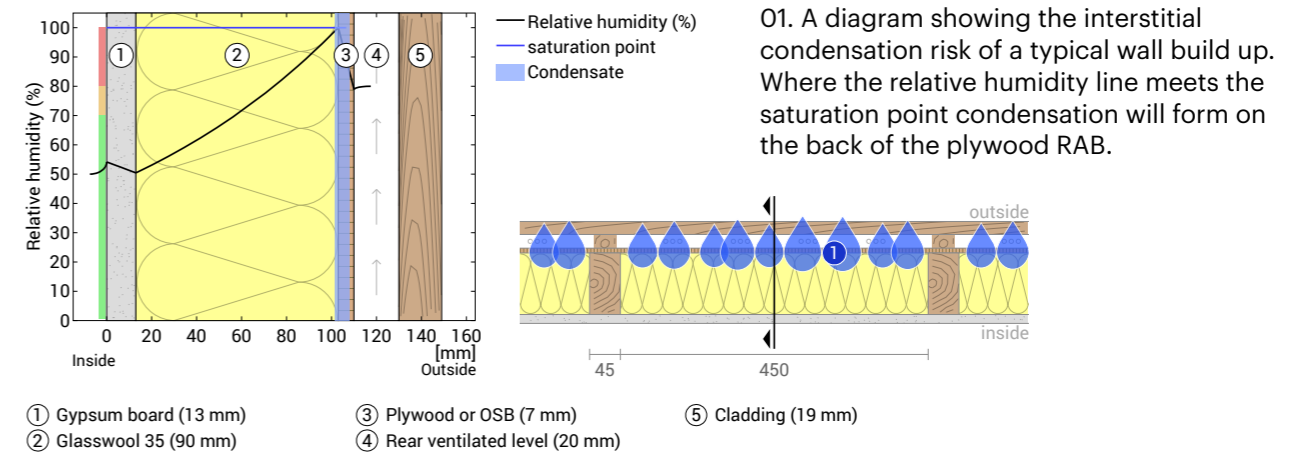



# Assemblies

 **HC1: Winter Comfort**

 **HC2: Summer Comfort**

 **HC4: Moisture Control**

 **EN2: Embodied Carbon**



# Assemblies

## Why?

Different construction assemblies (or build-ups) perform in diverse ways based on the location, temperature, humidity, etc. We also need to balance the costs and client requirements.

There are a range of construction typologies available, each with their positives and negatives.

In this chapter we will introduce a range of build-ups for walls, floors, roofs, and joinery installations, and set out some properties of each. This list is not exhaustive but includes a range of standard and best practice build-ups.

Depending on the climate, site conditions and building design it may be possible to use a range of build-ups to achieve the required Homestar and performance level. However, thermally modelling the project will be the primary way to assess which is most suitable.

Each assembly is part of the three control layers, all of which must be continuous.

Each assembly is part of the three control layers, all of which must be continuous.

- ☑ Weathertightness
- ☑ Thermal envelope
- ☑ Airtightness

Any break in these, or junction between them has the potential for water ingress, thermal bridging or air leaks. These are covered in further detail in the [Moisture Control chapter](#).

NB: Provided R-values are for information only - R-values of build-ups should be calculated for each build-up in each project using ECCHO.

For insulation the thermal conductivity of the product has been noted in W/mK along with the assumed timber content, to demonstrate where the R-values have been derived from.

In the case of details containing steel framing, you aren't able to use ISO 6946 utilised by ECCHO due to the magnitude of difference in thermal conductivity of materials which invalidates the result, so other softwares are necessary.

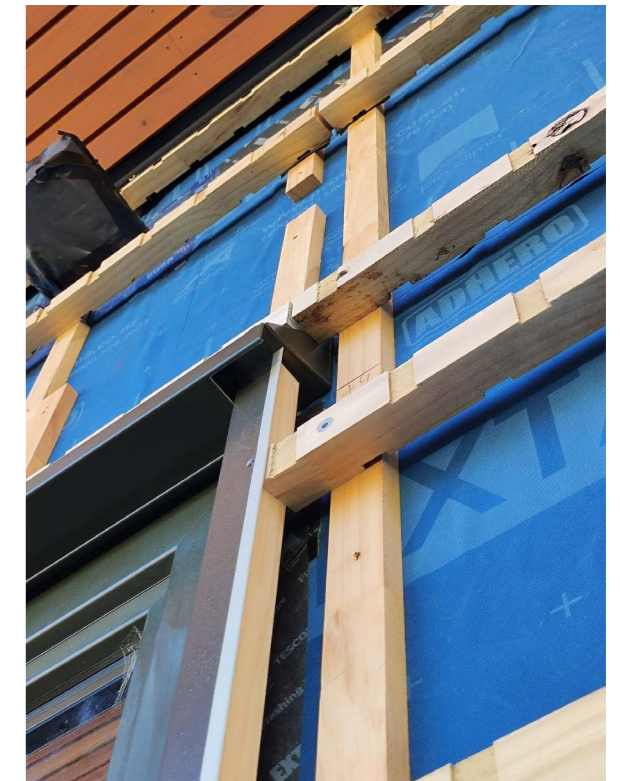

## Included assemblies

### Walls

- ✦ 90mm timber framing
- ✦ 140mm timber framing
- ✦ Concrete/ blockwork
- ✦ Insulated concrete formwork (ICF)
- ✦ External insulation – timber stud
- ✦ External insulation – steel stud
- ✦ Structural insulated panels (SIPs)

### Floors

- ✦ Suspended timber
- ✦ Structural insulated panels (SIPs)
- ✦ Concrete flat slab – insulation under
- ✦ Concrete flat slab – insulation over
- ✦ Concrete waffle pod – insulation under
- ✦ Concrete waffle pod – insulation over

### Roof/ ceiling

- ✦ Timber trusses with insulation between
- ✦ Timber rafter skillion
- ✦ Structural insulated panels (SIPs)
- ✦ External insulation – timber structure
- ✦ External insulation – steel structure
- ✦ External insulation – concrete structure

### Joinery installation

- ✦ Thermally broken aluminium windows – non-recessed
- ✦ Thermally broken aluminium windows – recessed
- ✦ UPVC windows – recessed
- ✦ Timber and aluminium windows - recessed

## A note on framing ratios

Historically it has been deemed acceptable to consider 15% timber content in wall framing when judging R-values. However, a BRANZ study showed that in reality this was much higher - an average of 36%.

This means that a standard 90mm wall with R2.8 insulation will, in reality, not meet the H1 minimum levels of insulation, and will result in far more heat loss and thermal bridging than assumed.

To this end 30% timber content is the default value to be used in Homestar, unless it can be shown that steps have been taken to reduce the timber content through reducing nogs/ dwangs, utilising 2 stud corners, and generally interrogating the wall and roof framing design.

Many framing suppliers are in the process of working through this requirement, and will provide shop drawings if requested.

### Things to look out for

When aiming to reduce the timber required in walls there are several key things you can consider:

- ✚ **Corners** - traditional corners have a lot of timber in them. This can easily be reduced to a '2 stud' corner with a single piece of timber at the end of each wall for cladding fixing, and metal channels or 'stud savers' internally for linings fixing.
- ✚ **Nogs/ dwangs** - If you have a rigid wall underlay you don't need nogs for bracing under NZS3604, so they can be removed. You may need timber for cladding fixings, in which case you can use 45x45 nogs installed on site, or 90x45 installed vertically to enable insulation to run over them, or use structural cavity battens to remove the need for them together.
- ✚ **Stud spacings** - sometimes framers will automatically show studs at 400 or 450 centres, when 600 centres will suffice. Always check the shop drawings!

The easiest way to avoid timber content issues, is to put the insulation on the outside of the frames - see the external insulation details within this chapter.

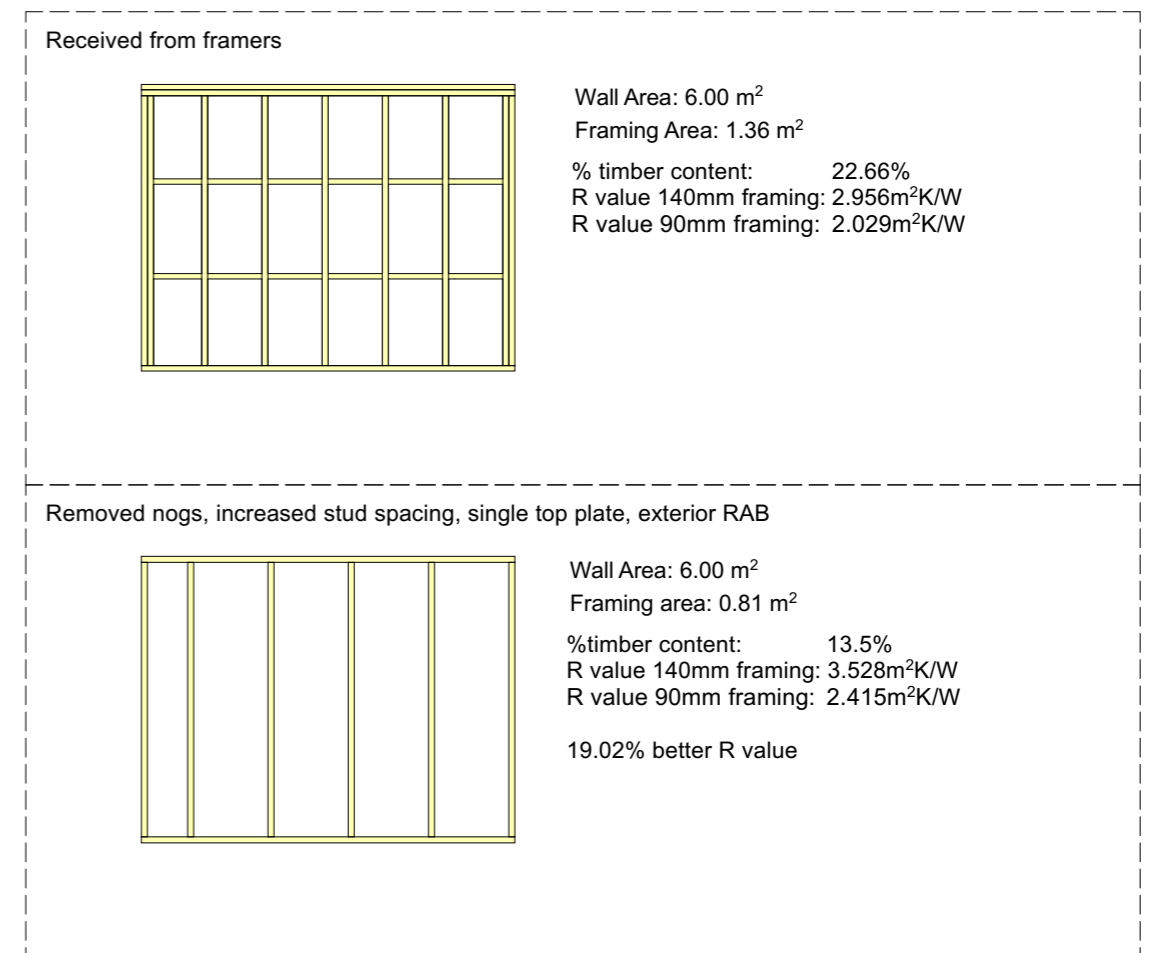

Standard Corner

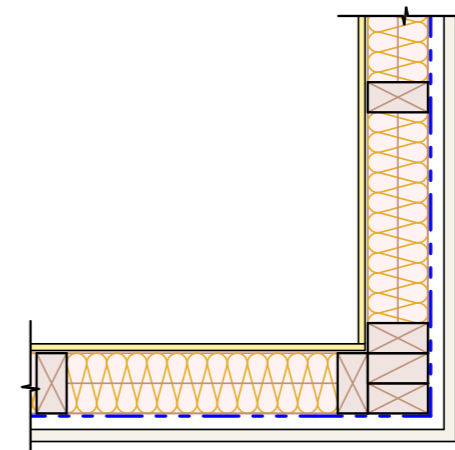

2 stud corner + fixing angle

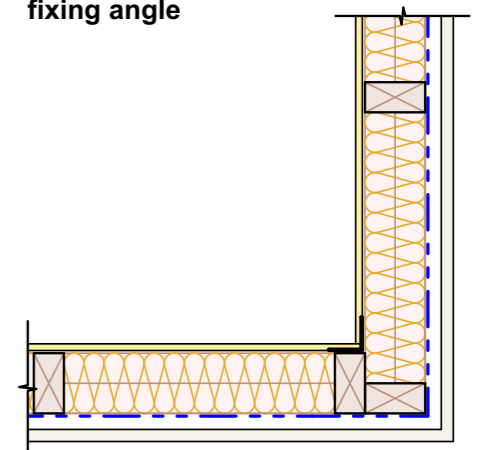



## Walls - 90mm timber framing

- ✔ Typical construction, so all builders will be familiar
- ✔ 30% timber content doesn't meet code minimum R-values
- ✔ Interstitial condensation and mould risk due to lack of an airtightness layer
- ✔ Cantilevering a 90mm stud over adequate slab edge insulation can be challenging
- ✔ Addition of services cavity is a simple upgrade which increases performance, and enables the addition of a protected airtightness layer.
- ✔ An uninsulated cavity will be required to protect the airtightness layer if insulation is not required. If not using an airtightness layer then sealing the top and bottom plates can be an effective approach to increasing airtightness
- ✔ Still need to assess timber content and ensure 2 stud corners, etc.

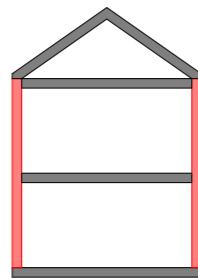

### 90mm FRAMING

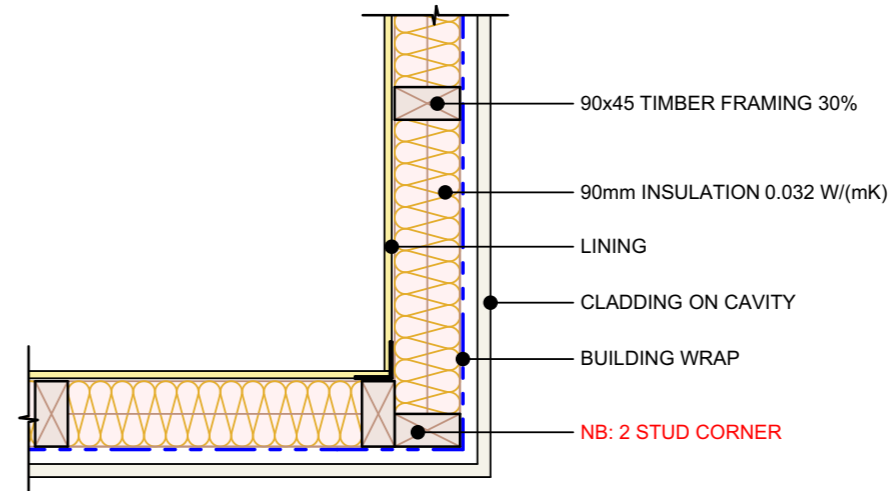

**R value: 1.83m<sup>2</sup>K/W**

### 90mm FRAMING + 20mm SERVICES CAVITY, AIRTIGHTNESS LAYER & LINING

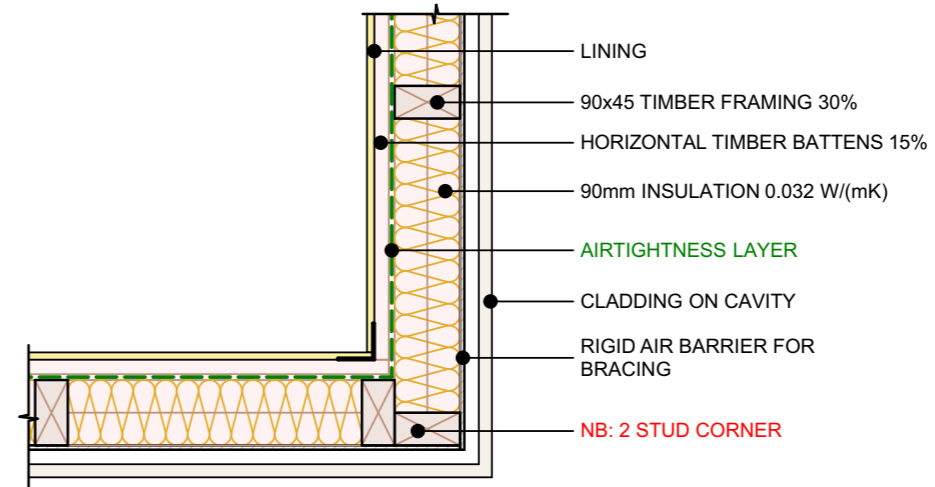

**R value: 2.09m<sup>2</sup>K/W**

### 90mm FRAMING + 45mm INSULATED SERVICES CAVITY, AIRTIGHTNESS LAYER & LINING

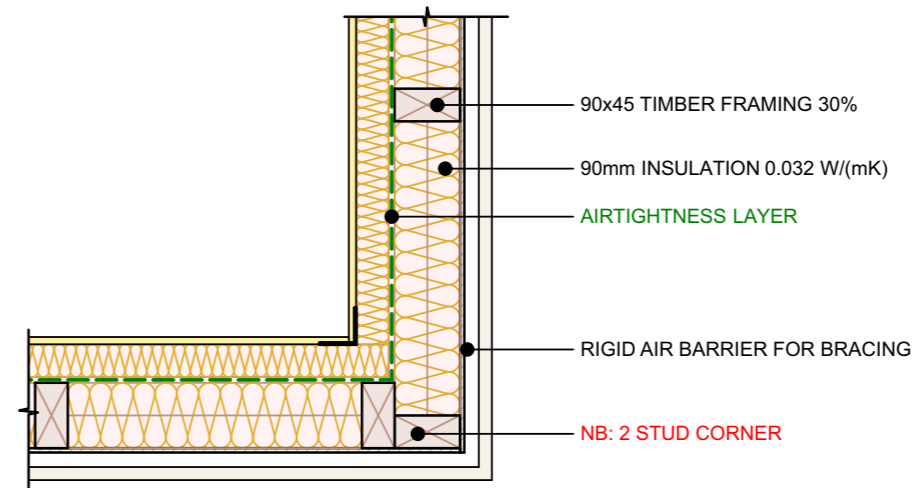

**R value: 2.95m<sup>2</sup>K/W**



## Walls - 140mm timber framing

- ✦ Typical construction, so all builders will be familiar
- ✦ Interstitial condensation and mould risk due to lack of an airtightness layer
- ✦ Can easily accommodate slab edge insulation overhang
- ✦ Addition of services cavity is a simple upgrade which increases performance, and enables the addition of a protected airtightness layer
- ✦ An uninsulated cavity will be required to protect the airtightness layer if insulation is not required. If not using an airtightness layer then sealing the top and bottom plates can be an effective approach to increasing airtightness
- ✦ Still need to assess timber content and ensure 2 stud corners, etc.

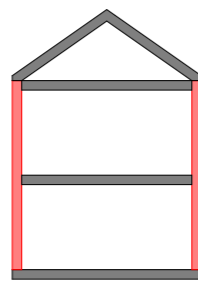

### 140mm FRAMING

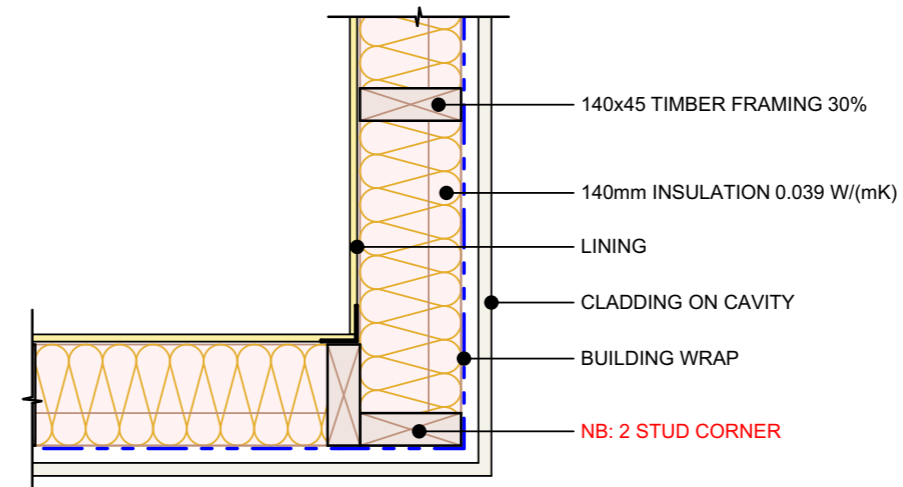

R value: 2.46m<sup>2</sup>K/W

### 140mm FRAMING + 20mm SERVICES CAVITY, AIRTIGHTNESS LAYER & LINING

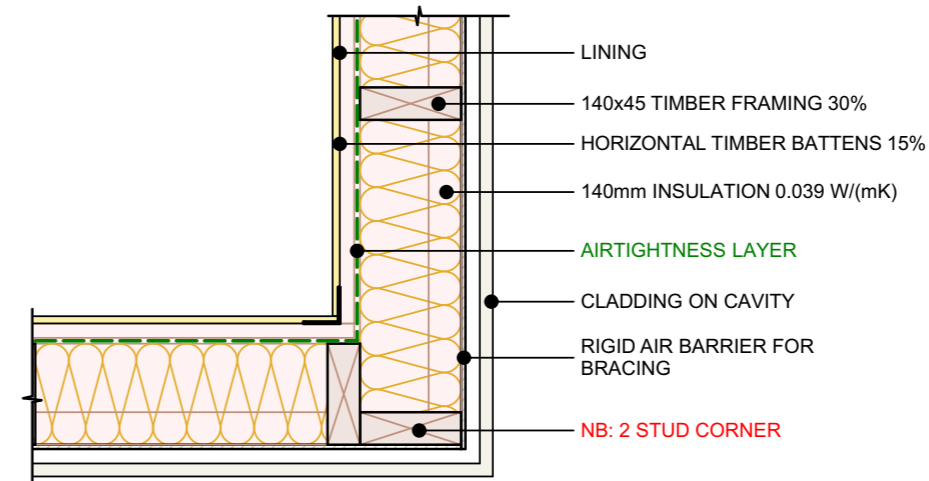

R value: 2.73m<sup>2</sup>K/W

### 140mm FRAMING + 45mm INSULATED SERVICES CAVITY, AIRTIGHTNESS LAYER & LINING

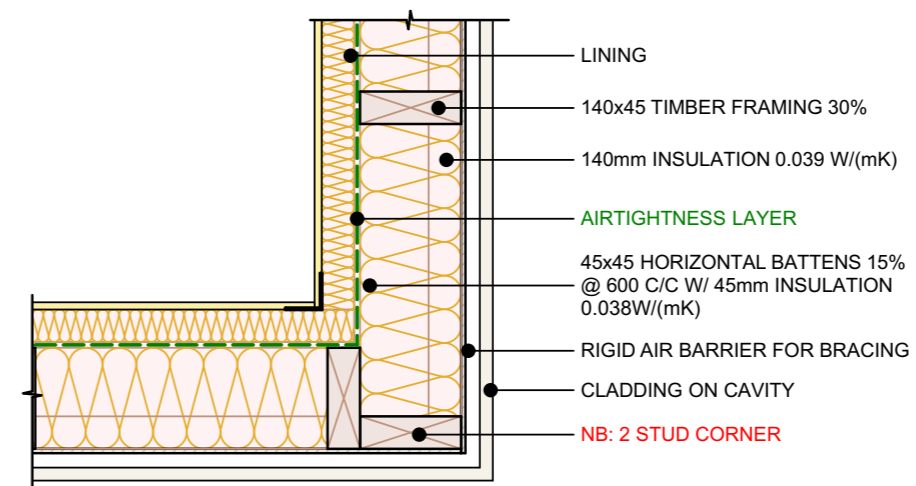

R value: 3.03m<sup>2</sup>K/W

## Walls - Structural Insulation Panels (SIPs)

- ✔ Less timber content than framing
- ✔ Insulation core options - EPS, PIR
- ✔ Faster on site, and prefabrication opportunities
- ✔ Can be exposed finish
- ✔ Can be higher carbon than timber walls
- ✔ More expensive material
- ✔ Less flexibility to change on site
- ✔ Running services in panels is not ideal.

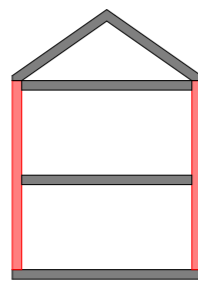

### 115mm SIPs - EXPOSED FINISH

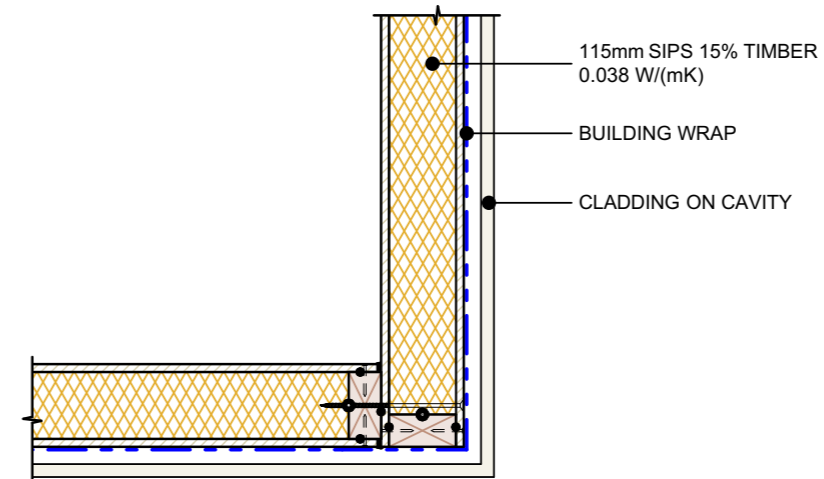

**R value: 2.28m<sup>2</sup>K/W**

### 115mm SIPs + 20mm SERVICES CAVITY & LINING

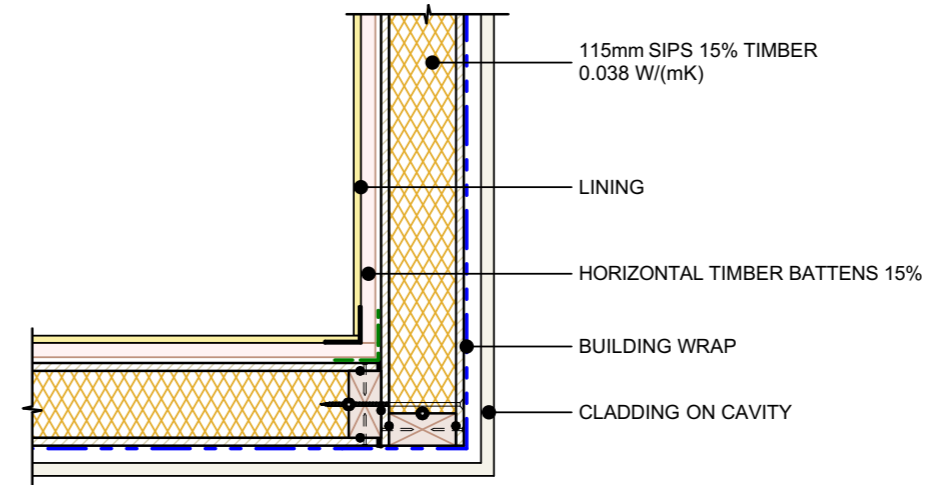

**R value: 2.52m<sup>2</sup>K/W**

### 115mm SIPs + 45mm INSULATED SERVICES CAVITY & LINING

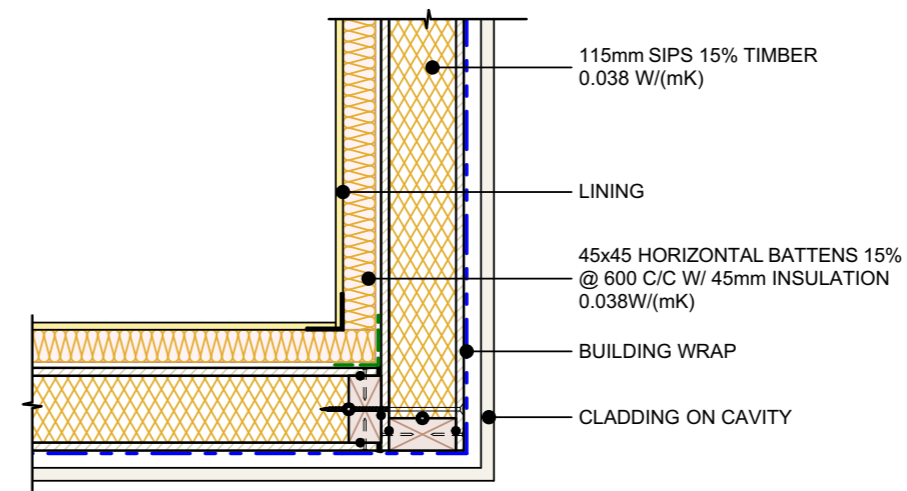

**R value: 3.36m<sup>2</sup>K/W**

## Walls - exterior insulation over timber framing

- ✔ Simple upgrade for minimal additional wall thickness
- ✔ Framing available for services circulation
- ✔ Airtightness and vapour control combined
- ✔ Insulation can run past slab edge and mid-floors
- ✔ Necessary to assess fire risk of different insulation products
- ✔ If insulating within framing too, the inner insulation R-value must be no more than 1/3 of the outer insulation R-value, to avoid the potential for Interstitial condensation (normally hygrothermal modelling is required to confirm this).
- ✔ Attention needs to be paid to not trapping moisture inside the frame. For this reason fibrous insulation is preferred.
- ✔ We strongly recommend hygrothermal modelling when combining different insulation types as in bottom detail.

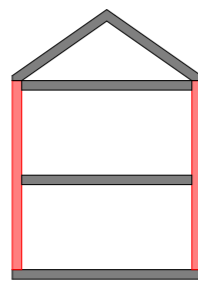

### 90mm FRAMING, 50mm EXTERIOR PIR

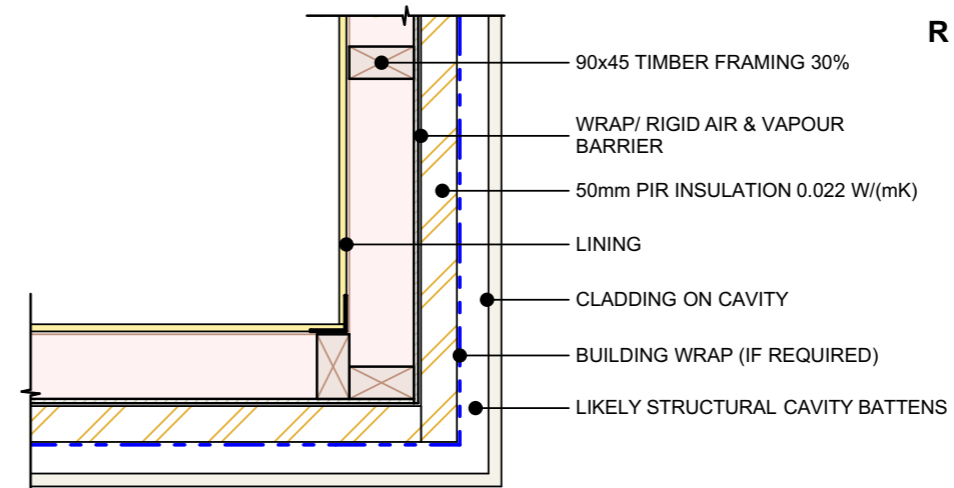

R value: 2.90m<sup>2</sup>K/W

### 90mm FRAMING, 100mm EXTERIOR PIR

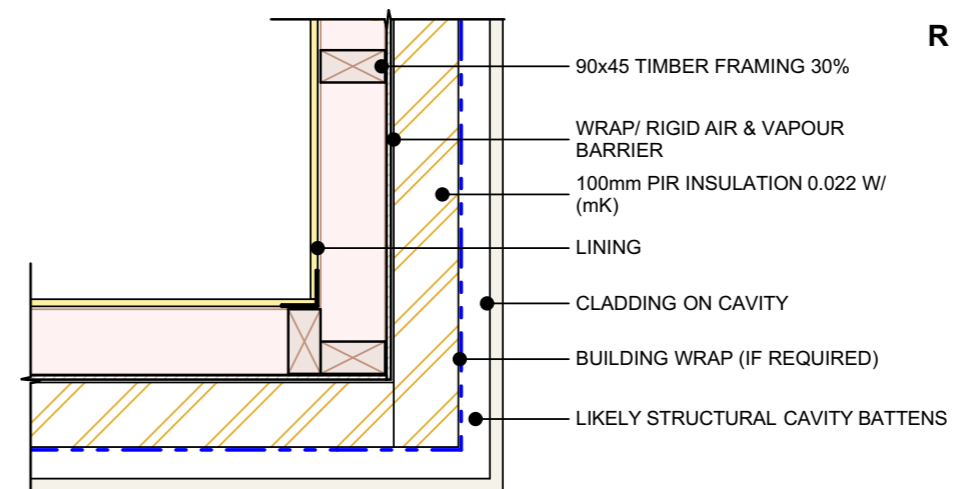

R value: 4.96m<sup>2</sup>K/W

### 90mm INSULATED FRAMING + 20mm SERVICES CAVITY, 50mm EXTERIOR PIR

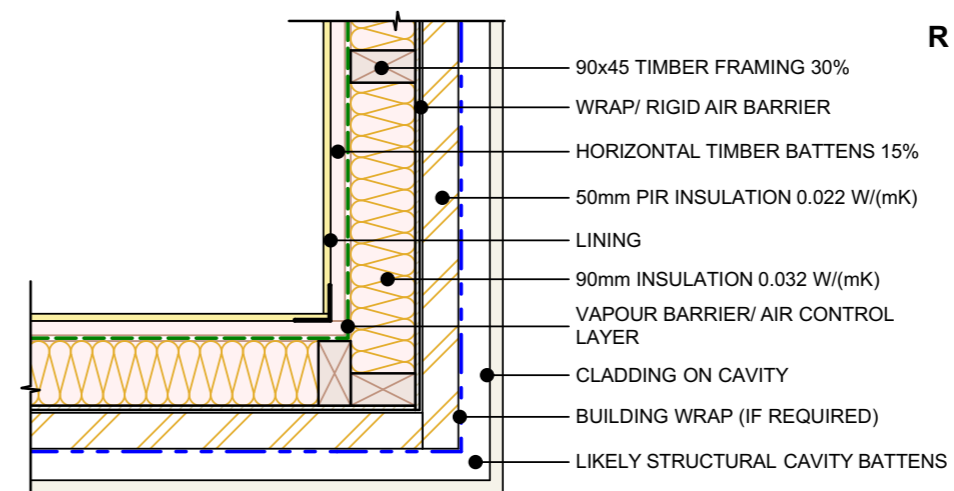

R value: 4.32m<sup>2</sup>K/W

## Walls - exterior insulation over metal and concrete

- Simple upgrade for minimal additional wall thickness
- Framing available for services circulation
- Airtightness and vapour control combined
- Higher embodied carbon in concrete and steel than timber
- Insulation can run past slab edge and mid-floors
- Necessary to assess fire risk of different insulation products
- With ICF getting the slab to wall connection detail can be tricky to avoid a thermal bridge
- Insulating concrete internally is not allowed in Homestar due to interstitial condensation risk.

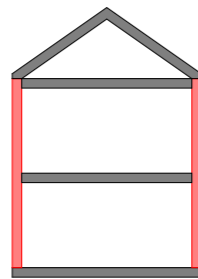

### 90mm ALUMINIUM FRAMING, 50mm EXTERIOR PIR

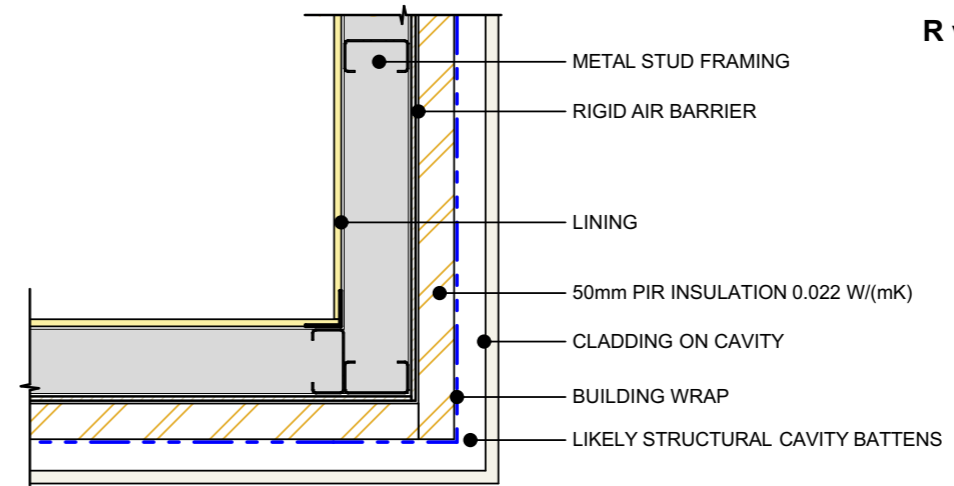

R value: 2.69m<sup>2</sup>K/W

### 140mm CONCRETE + 20mm SERVICES CAVITY, 50mm EXTERIOR PIR

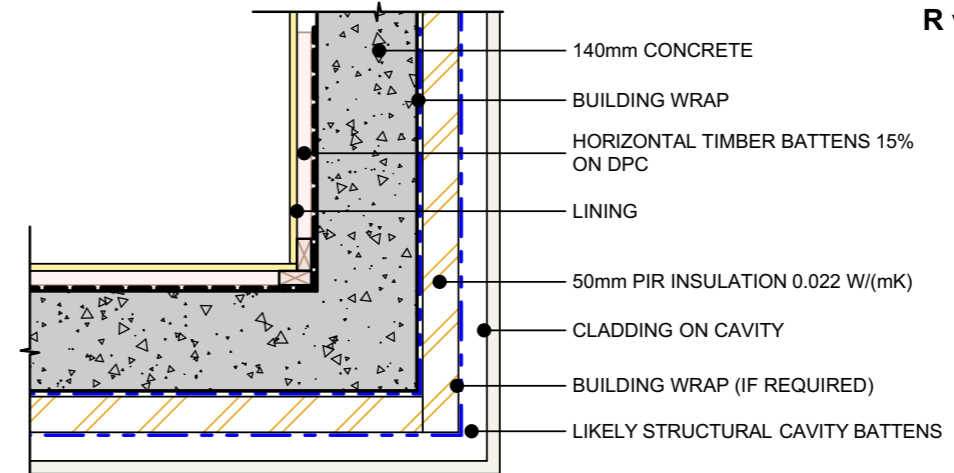

R value: 2.69m<sup>2</sup>K/W

### 230mm IFC BLOCKWORK + 20mm SERVICES CAVITY

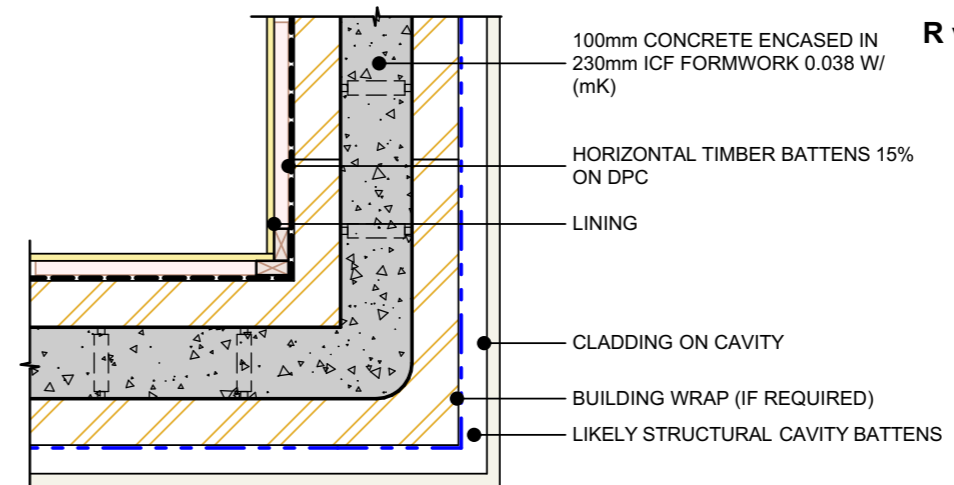

R value: 3.84m<sup>2</sup>K/W



## Walls - exterior insulation over Cross Laminated Timber (CLT)

- ✔ Airtightness and vapour control combined
- ✔ Insulation can run past slab edge and mid-floors
- ✔ Necessary to assess fire risk of different insulation products
- ✔ Services require careful coordination to ensure all runs are pre-routed, visible, or additional strap and lining to conceal them
- ✔ Can leave the CLT exposed internally, so no need for additional lining.

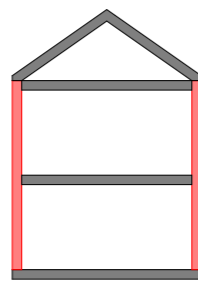

### 90mm CLT, 50mm EXTERIOR PIR

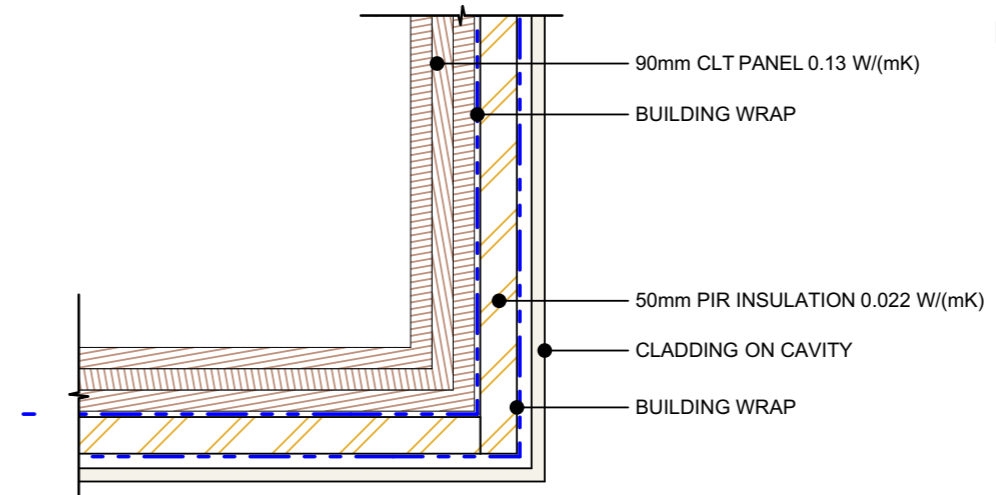

**R value: 3.23m<sup>2</sup>K/W**

## Floors - suspended timber

- ✔ Easy to achieve insulation requirements
- ✔ No slab edge thermal bridge to deal with
- ✔ Can access and maintain services beneath
- ✔ Minimises the amount of excavation and levelling required on steeper sites.

### SIPs

- ✔ SIPs floor can achieve long spans, minimising the amount of piles/ bearers
- ✔ SIPs have less timber content than framing, so higher performance for the same thickness
- ✔ However, they will be higher carbon
- ✔ Insulation core options - EPS, PIR
- ✔ Faster on site, and prefabrication opportunities
- ✔ More expensive material
- ✔ Less flexibility to change on site.

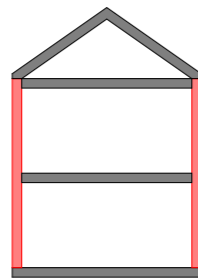

### 225mm SIPs FLOOR

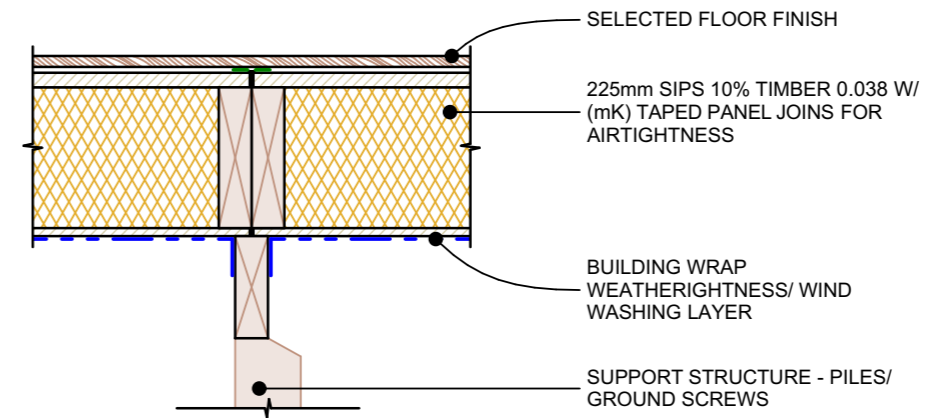

### 240mm SUSPENDED TIMBER FLOOR

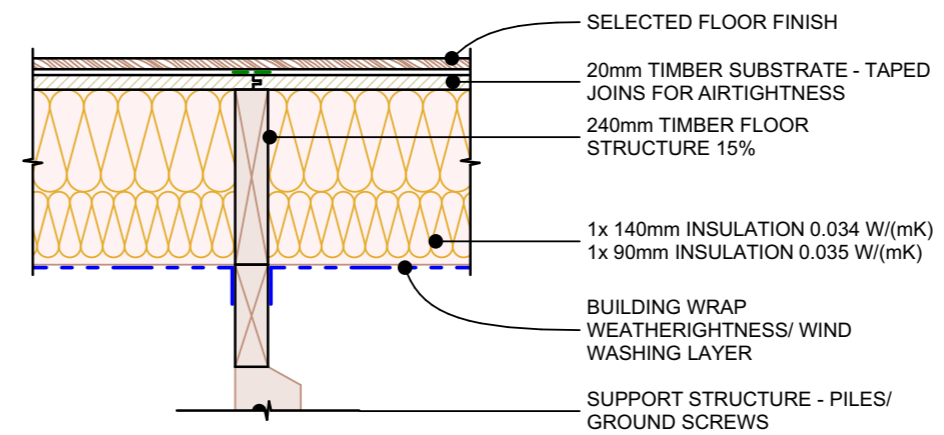

## Floors - concrete flat slab

### Insulation on top of slab

- ☞ Makes utilising masonry cladding easier as no thermal bridge, and no slab edge insulation required
- ☞ Need to deal with thermal bridge connections between slab and steel structure
- ☞ Higher embodied carbon than timber floors, even with lower embodied carbon options.

### Insulation beneath the slab

- ☞ Standard construction
- ☞ Masonry cladding base detail won't meet fRsi requirements
- ☞ Means the thermal mass can be utilised, and dematerialisation through a concrete finished floor
- ☞ Higher embodied carbon, even with lower embodied carbon options.

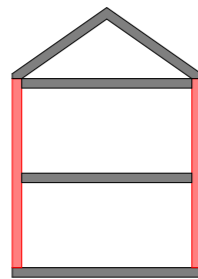

### 100mm SLAB, 50mm PIR INSULATION ON TOP

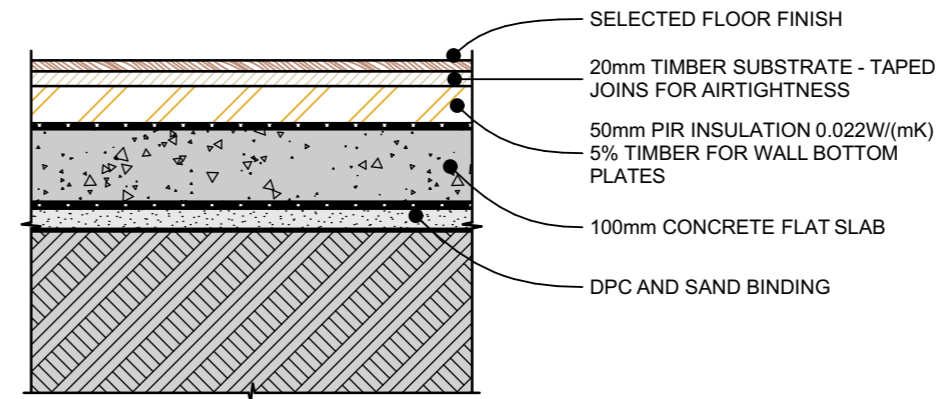

**R value: 2.27m<sup>2</sup>K/W**

### 100mm SLAB, 100mm XPS INSULATION BENEATH

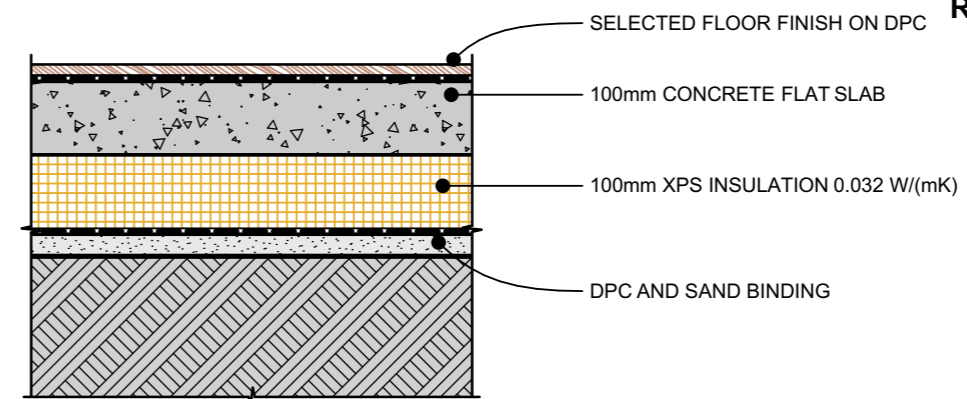

**R value: 3.34m<sup>2</sup>K/W**

## Floors - concrete waffle pod slab

### Insulation on top of slab

- ✚ Makes utilising masonry cladding easier as no thermal bridge, and no slab edge insulation required
- ✚ Need to deal with thermal bridge connections between slab and steel structure
- ✚ Higher embodied carbon than timber floors, even with lower embodied carbon options.

### Insulation beneath the slab

- ✚ Standard construction
- ✚ Masonry cladding base detail won't meet fRsi requirements
- ✚ Means the thermal mass can be utilised, and dematerialisation through a concrete finished floor
- ✚ Higher embodied carbon than timber floors, even with lower embodied carbon options.

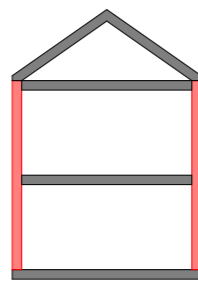

### 85mm CONCRETE 220mm WAFFLE POD SLAB WITH 50mm PIR INSULATION ON TOP

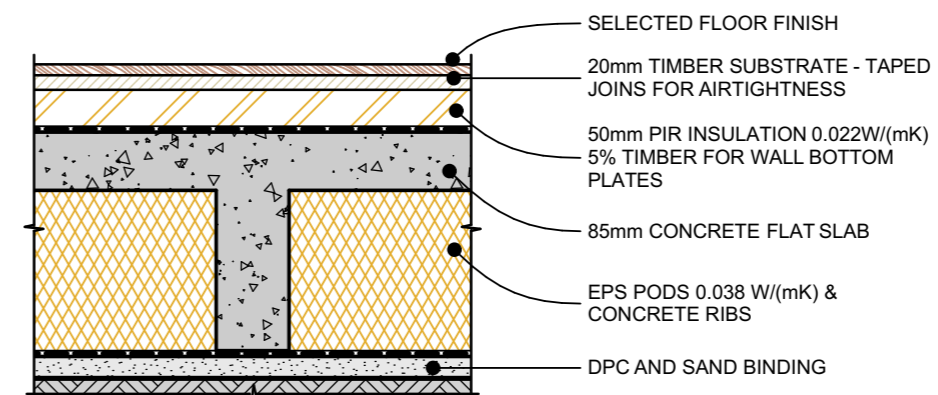

R value: 2.84m<sup>2</sup>K/W

### 85mm CONCRETE 220mm WAFFLE POD SLAB WITH 50mm XPS INSULATION BENEATH

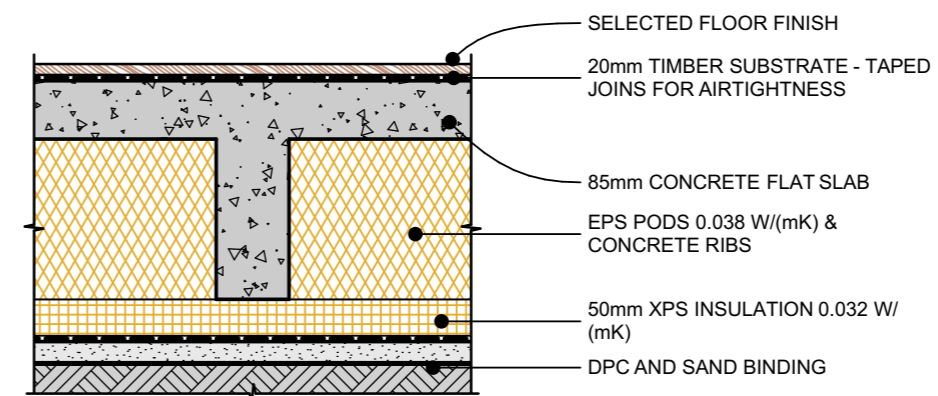

R value: 2.31m<sup>2</sup>K/W



## Roof - Structural Insulated Panels (SIPs)

- ✔ Less timber content than framing
- ✔ Insulation core options - EPS, PIR
- ✔ Faster on site, and prefabrication opportunities
- ✔ Can be exposed finish
- ✔ Can be higher carbon than timber framing
- ✔ More expensive material
- ✔ Less flexibility to change on site
- ✔ Running services in panels is not ideal.

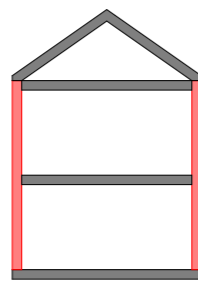

### 215mm SIPs - EXPOSED FINISH

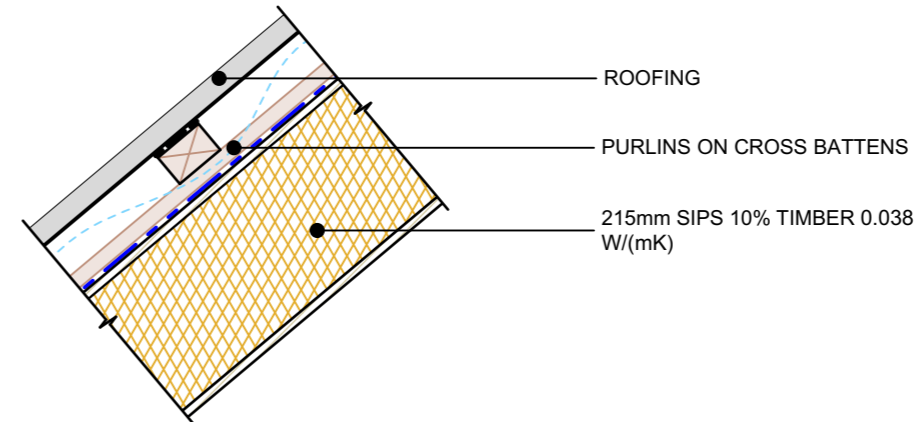

**R value: 4.47m<sup>2</sup>K/W**

### 215mm SIPs + 20mm SERVICES CAVITY & LINING

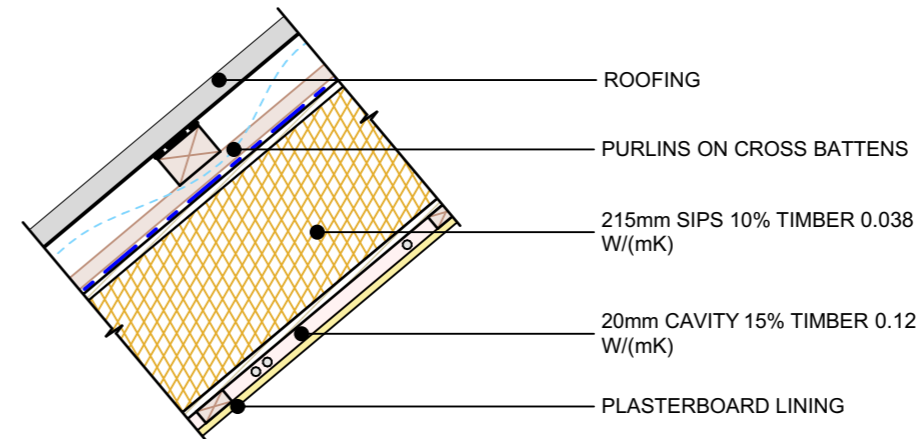

**R value: 4.70m<sup>2</sup>K/W**

### 215mm SIPs + 90mm INSULATED SERVICES CAVITY & LINING

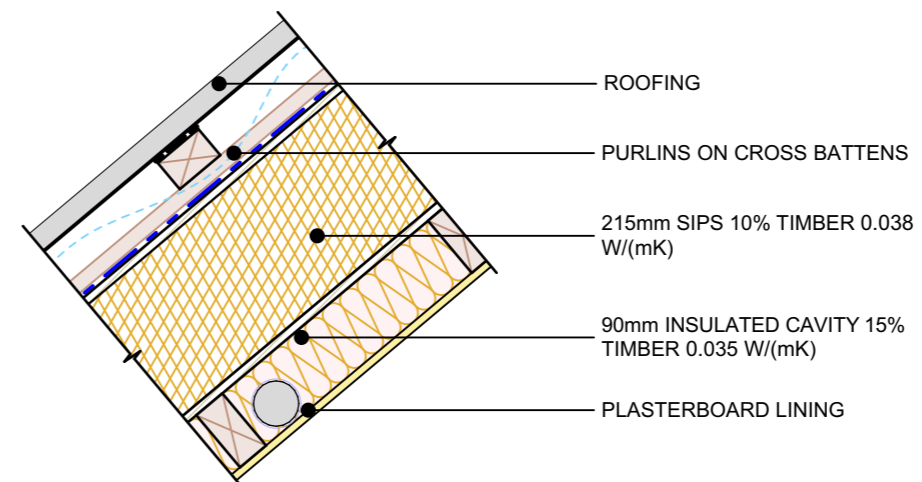

**R value: 6.70m<sup>2</sup>K/W**

## Roof - timber rafter skillion

- ✔ Typical construction, so all builders will be familiar
- ✔ Airtightness layer required due to high interstitial condensation and mould risk
- ✔ Achieving R6.6 can lead to increased thickness
- ✔ Addition of services cavity is a simple upgrade which can be insulated to increase performance if required, and enables the addition of an airtightness layer with protection from penetrations.

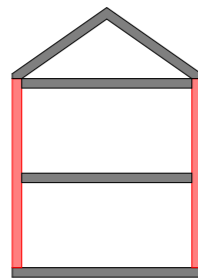

### TIMBER RAFTER SKILLION - 20mm SERVICES CAVITY

**R value: 4.38m<sup>2</sup>K/W**

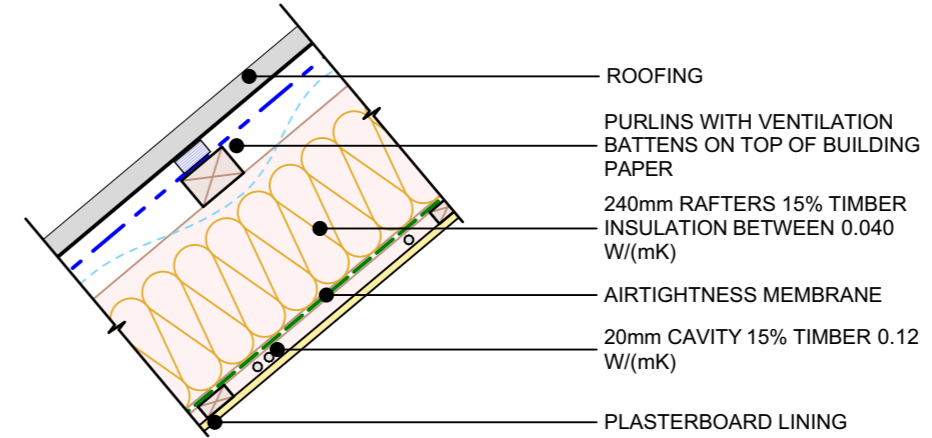

### TIMBER RAFTER SKILLION - 90mm SERVICES CAVITY

**R value: 6.43m<sup>2</sup>K/W**

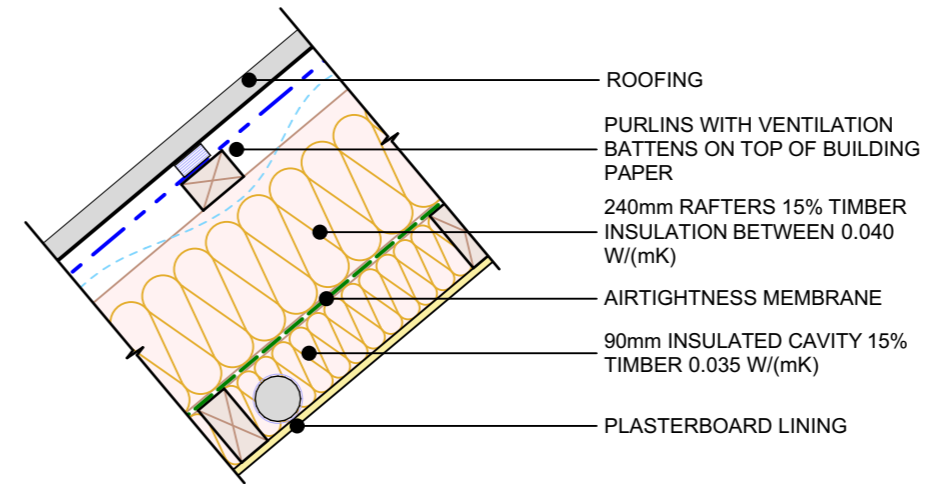

## Roof - timber trusses and insulation at ceiling level

- ✚ Typical construction, so all builders will be familiar
- ✚ Airtightness layer required due to severe interstitial condensation and mould risk
- ✚ Achieving R6.6 can lead to increased thickness
- ✚ Consideration of the eave detail required, and minimum heel height to ensure minimum insulation thickness achieved
- ✚ Lots of room to add insulation once the minimum has been achieved. However, diminishing returns to consider once past a certain thickness
- ✚ Addition of services cavity is a simple upgrade which increases performance, and enables the addition of a protected airtightness layer.

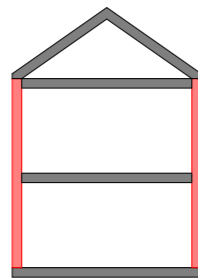

### INSULATION BETWEEN & OVER 140mm TRUSSES + 20mm SERVICES CAVITY & LINING

**R value: 5.97m<sup>2</sup>K/W**

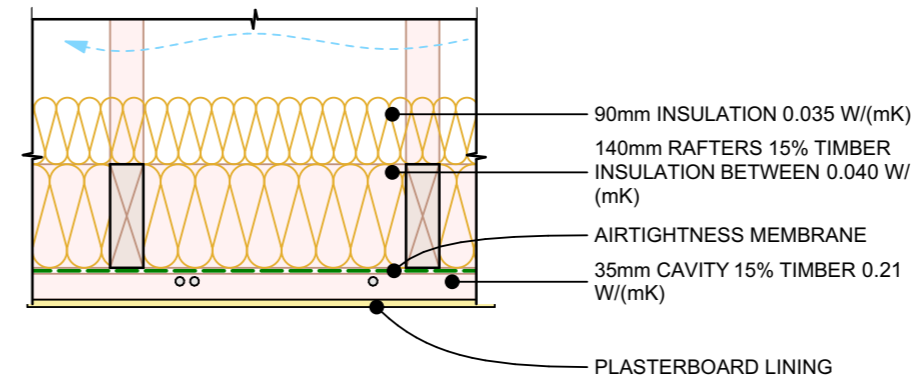

### INSULATION BETWEEN & OVER 140mm TRUSSES + 20mm SERVICES CAVITY & LINING

**R value: 6.88m<sup>2</sup>K/W**

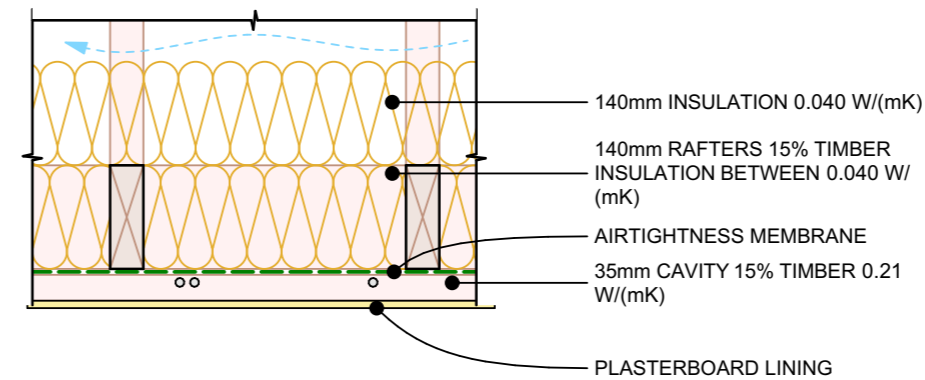

### INSULATION BETWEEN 140mm TRUSSES + 90mm INSULATED SERVICES CAVITY & LINING

**R value: 8.76m<sup>2</sup>K/W**

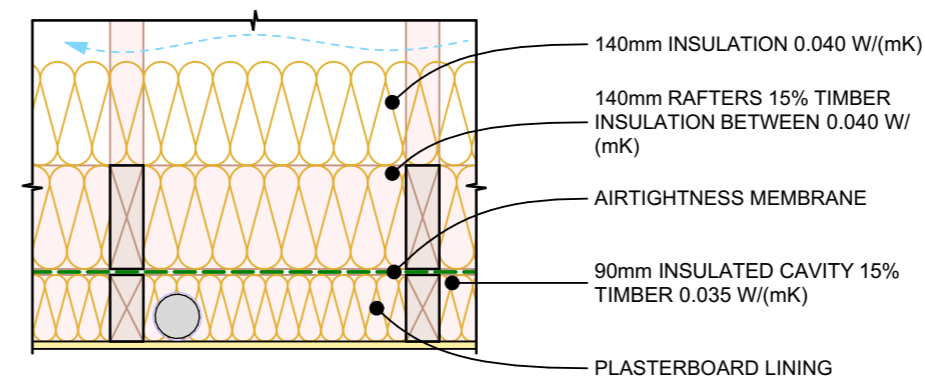

## Roof - metal purlins and exterior insulation

- ✔ Typical construction, so all builders will be familiar
- ✔ Insulation must be external of the structure to avoid thermal bridging
- ✔ Substrate and airtightness layer combined
- ✔ Higher carbon than timber purlins
- ✔ Consideration of the eave detail required due to insulation being over the structure
- ✔ Addition of services cavity is a simple upgrade which increases performance, and enables the addition of a protected airtightness layer.

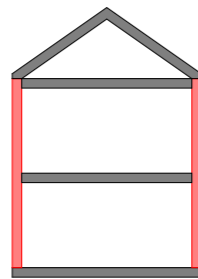

### EXTERNAL INSULATION - EXPOSED STEEL RAFTERS

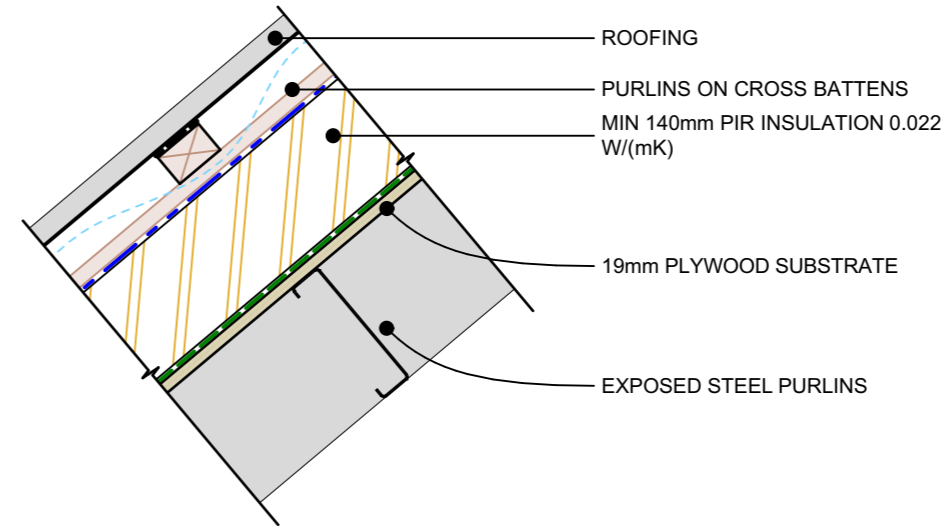

R value: 6.65m<sup>2</sup>K/W

### EXTERNAL INSULATION - ENCLOSED SERVICES CAVITY

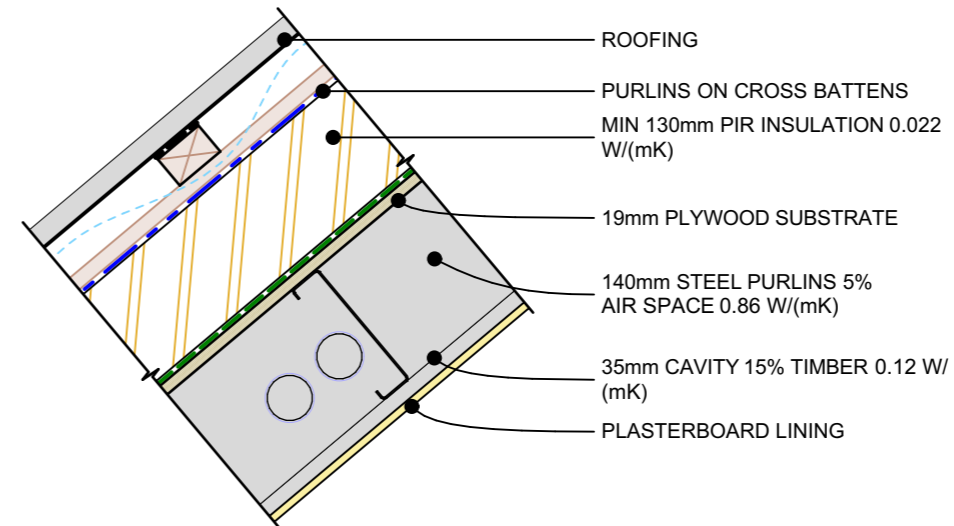

R value: 6.52m<sup>2</sup>K/W



## Roof - timber purlins and exterior insulation

- ✔ Typical construction, so all builders will be familiar
- ✔ Substrate and airtightness layer combined
- ✔ Consideration of the eave detail required due to insulation being over the structure
- ✔ Can achieve higher R-values with less thickness than a skillion roof
- ✔ Addition of services cavity is a simple upgrade which increases performance, and enables the addition of a protected airtightness layer.

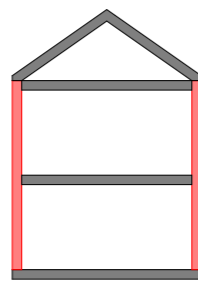

### EXTERNAL INSULATION - EXPOSED RAFTERS

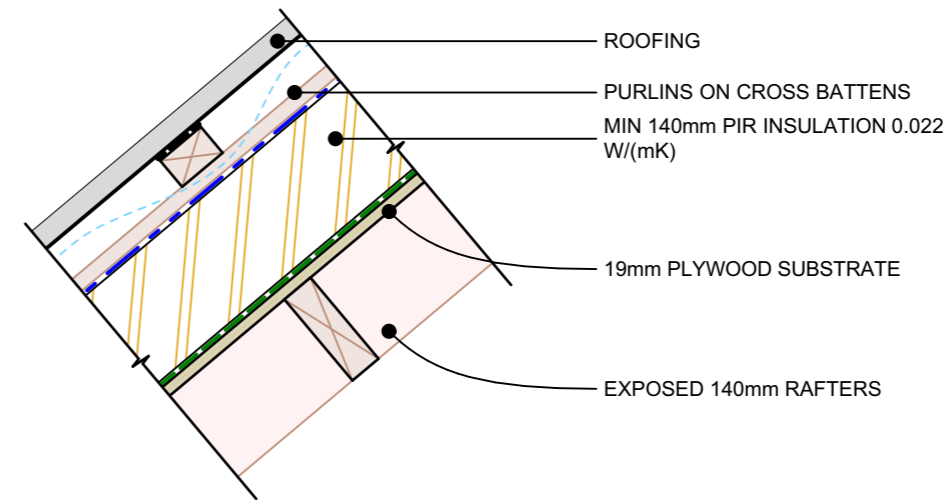

R value: 6.65m<sup>2</sup>K/W

### EXTERNAL INSULATION - ENCLOSED SERVICES CAVITY

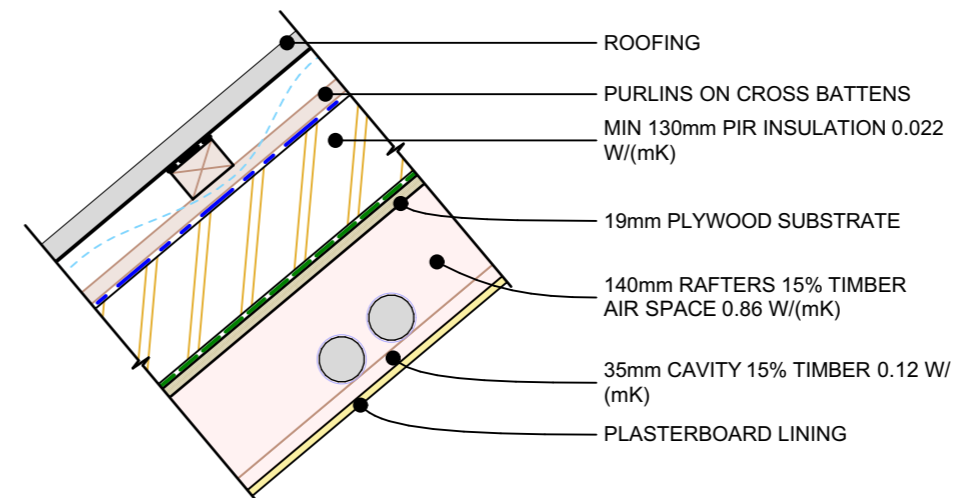

R value: 6.66m<sup>2</sup>K/W

### EXTERNAL INSULATION - INSULATED SERVICES CAVITY

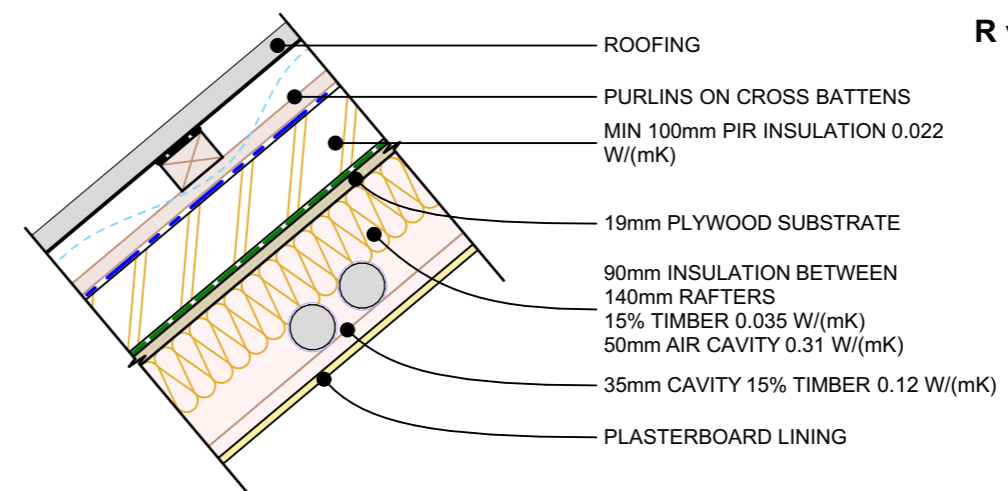

R value: 7.28m<sup>2</sup>K/W

## Roof - flat roof, warm roof

- ✔ Typical construction, so all builders will be familiar
- ✔ Substrate and airtightness layer combined
- ✔ Can achieve higher R-values with less thickness than a cold roof
- ✔ Services can just circulate within the structure, and additional insulation can be added if required with no additional thickness.
- ✔ External insulation with a services cavity presents a higher risk of interstitial moisture. Hygrothermal analysis (e.g. WUFI) is highly recommended in these instances.

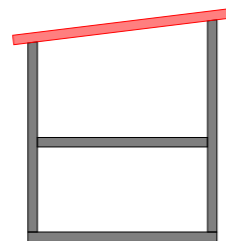

### EXTERNAL INSULATION - EXPOSED RAFTERS

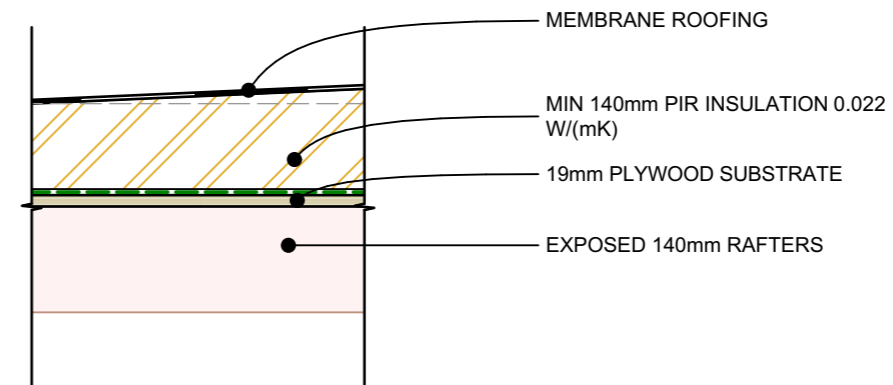

R value: 6.65m<sup>2</sup>K/W

### EXTERNAL INSULATION - ENCLOSED SERVICES CAVITY

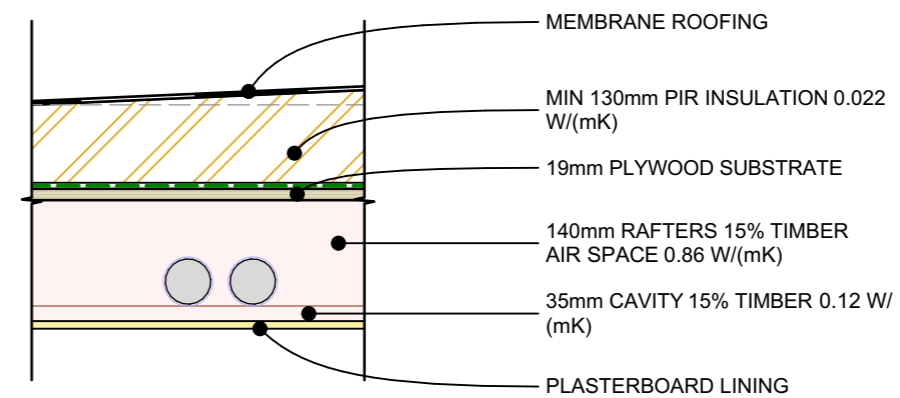

R value: 6.66m<sup>2</sup>K/W

### EXTERNAL INSULATION - INSULATED SERVICES CAVITY

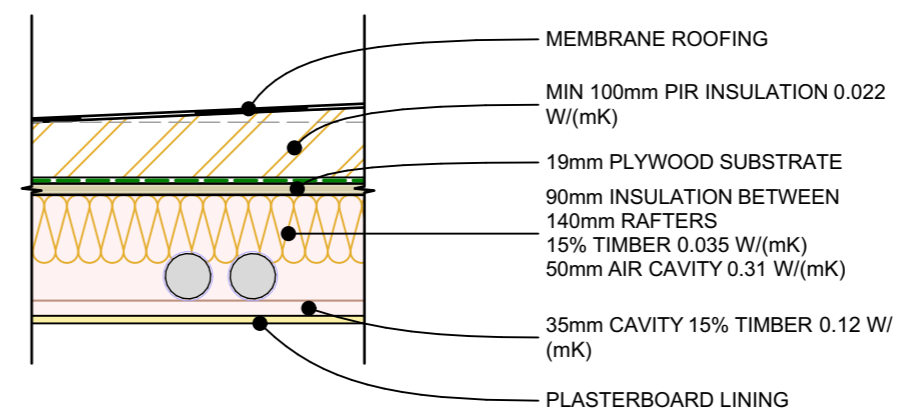

R value: 7.28m<sup>2</sup>K/W

## Roof - flat roof, cold roof

- ✔ Typical construction, so all builders will be familiar
- ✔ Requires airtightness layer due to significant interstitial condensation and mould risk
- ✔ Hygrothermal modelling recommended to assess moisture risk
- ✔ Services can just circulate within the structure, and additional insulation can be added if required with no additional thickness
- ✔ Addition of services cavity is a simple upgrade which increases performance.

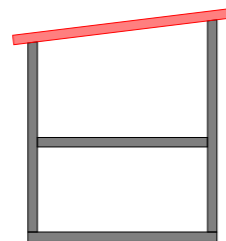

### INSULATION BETWEEN RAFTERS

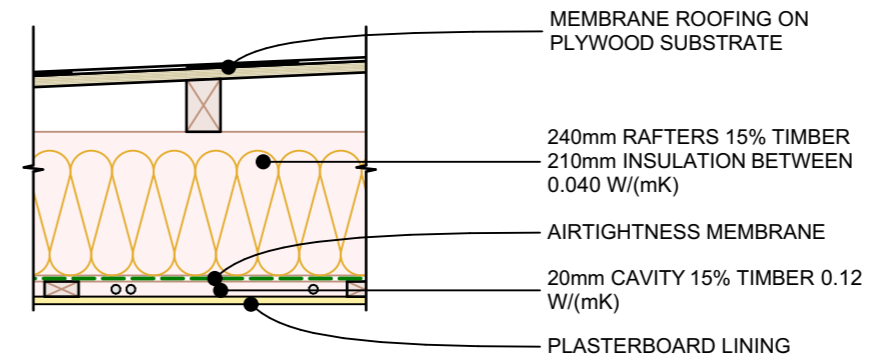

R value: 4.57m<sup>2</sup>K/W

### INSULATION BETWEEN RAFTERS - 90mm SERVICES CAVITY

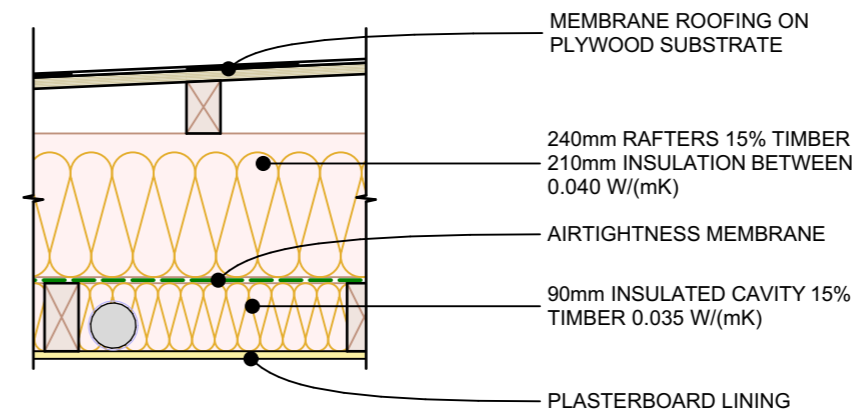

R value: 6.61m<sup>2</sup>K/W

## Windows

- Windows are part of the thermal envelope, weathertightness barrier and the airtightness strategy, and as such must be integrated continuously to all three
- If a thermally broken window is installed in line with the cladding, the thermal break is being bypassed and so is not doing anything
- As well as thermal performance, the airtightness of the unit when closed must be considered - multi-point locking systems are far better than single point handles
- If including trickle vents consider the position - having them at the top will likely result in less drafts at user level, and less likelihood that they will be blocked.

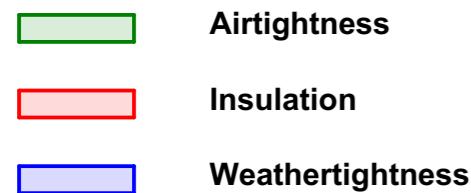

- 01 A non-thermally broken aluminium frame installed in line with the cladding as per NZ Building Code clause E2. The airtightness and insulation are both discontinuous.
- 02 A thermally broken window installed in line with the cladding - the thermal envelope is interrupted, leading to a thermal bridge. The junction between the timber reveal and aluminium window can also be weak for airtightness.
- 03 A thermally broken window installed back in line with the wall - the thermal envelope is nearly continuous, reducing any thermal bridging. The airseal still relies on the PEF rod and sealant.

- 04 Here the window is recessed, and the joinery frame has a flange which is taped back to the WRB - this enables the shim gap around the window to be fully filled with insulation to remove any thermal bridging.
- 05 Another version of this is tape, which is used to connect the window to the WRB - this also enables the shim gap around the window to be fully filled with insulation to remove any thermal bridging.
- 06 uPVC windows, installed in line with SIPs walls with proprietary flashings. All three control layers are unbroken.
- 07 Timber framed windows with aluminium facings, installed in line with SIPs walls. All three control layers are unbroken.

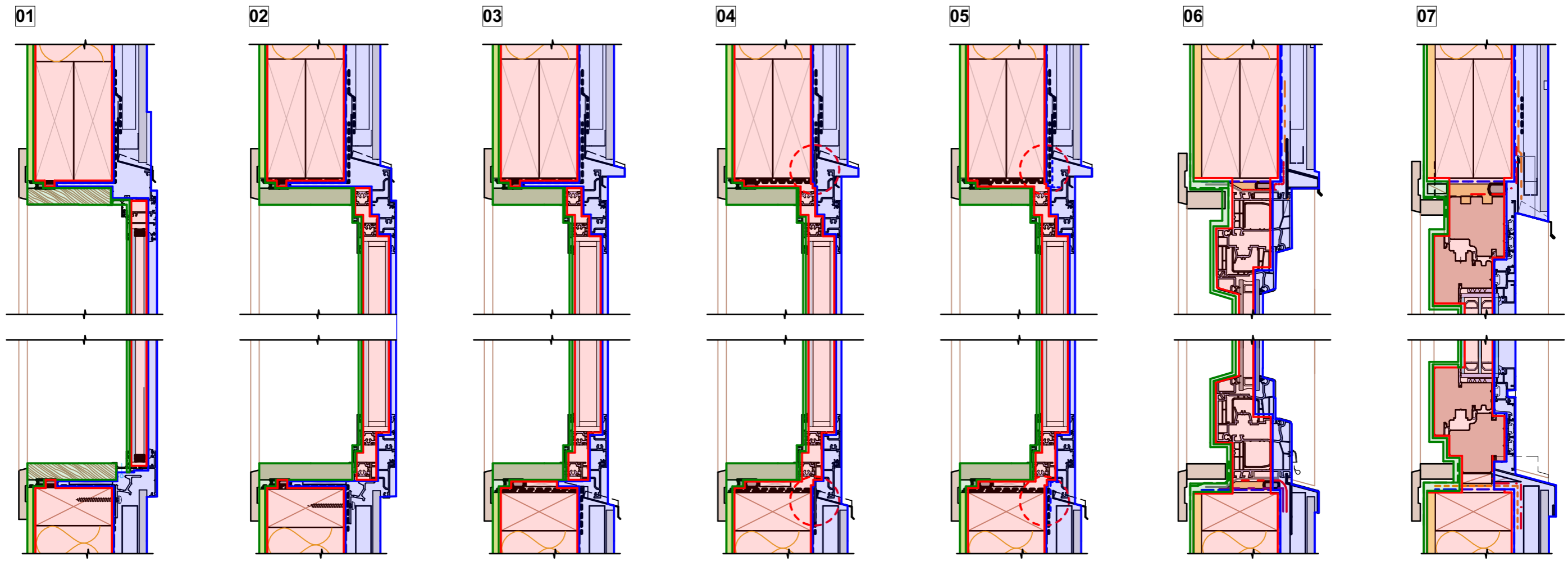



# Carbon



**EN2: Embodied Carbon**

©NZGBC 2024. NZGBC has presented the following guidance to promote better building standards and methods. The Homestar® name, logo or Homestar® rating specifications may only be used in relation to an application for or obtaining Homestar® certification. Projects that claim to meet the requirements of NZGBC rating schemes but are not certified are potentially in breach of trademark rules and may be accused of 'greenwash'.



# Embodied carbon and life cycle assessment overview

## Why?

Fifteen percent of the total greenhouse gas emissions in New Zealand relates to domestic buildings, according to the [Ministry for the Environment](#). Two thirds of that 15% comes from operational emissions, including on-site fossil fuel for heating and one third comes from [embodied emissions](#). In Homestar v5, all projects must carry out a full [life cycle assessment](#) module A-D of Lifecycle Assessment Standard EN15978. However, only upfront carbon (A1-A5) is related to the points awarded.

A typical new standalone house in New Zealand has upfront emissions of around 180kgs/m<sup>2</sup>. [BRANZ research](#) indicates we need to reduce this by 80% or more to meet our international obligations. There is no mandatory target to meet for the assessment result at the time this design guide was published. Instead, the aim is to provide the starting point to reduce greenhouse gas emissions associated with products and materials used to construct a home.

Although Homestar credit EN2 only covers embodied carbon A1-A5, a significant reduction in operational carbon will also be achieved thanks to the mandatory minimum requirements from Homestar credit EF4: Energy Use and Homestar credit EF3: Water Use. A reduction in embodied carbon is also recognised in Homestar credit EN3: Sustainable Materials and Homestar credit EN4: Construction Waste.

Therefore, we have included the full life cycle assessment example in this overview before we dive deeper into embodied carbon.

## The bigger picture

Undertaking a building life cycle assessment is about having the bigger picture of the environmental impact throughout the estimated service life of 90 years (in Homestar protocol - note this can differ in other methodologies). Although Homestar credit EN2 only covers embodied carbon A1-A5, a significant reduction in operational carbon will also be achieved thanks to the mandatory minimum requirements from Homestar credit EF4: Energy Use and Homestar credit EF3: Water Use. A reduction in embodied carbon is also recognised in Homestar credit EN3: Sustainable Materials and Homestar credit EN4: Construction Waste. Therefore, we have included the full life cycle assessment example in this overview before we dive deeper into embodied carbon. For more information on the trajectory for housing construction emissions, see [Carbon Budget Sensitivities Analysis](#)

## Embodied carbon (A1-A5, B1-B5, C1-C4, D)

The product and construction stages (A1-A5) generally account for 15% of the total life cycle carbon emissions. Because most of the building materials and systems need maintenance and replacement (B1-B5) during the lifetime of a building, this roughly adds another 15%. High-performance buildings generally use more building materials up front. Therefore, it is common to see a slight increase in A1-A5 embodied carbon emission. It is important to note that biogenic carbon is excluded from the upfront emissions calculation in Homestar.

## Operational carbon - Operational energy (B6)

According to the reference buildings established by BRANZ, an average detached house in New Zealand has more than 50% of the total life cycle carbon emission coming from operational energy alone during the 90 year assessment period. (BRANZ has since changed to 50 year service lives to align with the MBIE WoLEC methodology). Depending on the climate, and according to the results of the four case studies in this guide, 6 Homestar levels of energy efficiency typically provides 10%-30% reduction in the total operational energy use. 8 Homestar typically provides 40%-60% reduction.

## Operational carbon - Operational water (B7)

When it comes to operational water use, the New Zealand mean winter water use is 159L per person per day, and the average summer water use is 231L/p/d according to BRANZ Study report SR469 (2022). Pumping and treating potable water requires energy. Hence water consumption has a carbon content. This accounts for about 10% of a building's life cycle carbon emissions. 6 Homestar level of water efficiency generally means about 40% reduction compared to New Zealand's benchmark, while 8 Homestar can result in a reduction of over 50%.

# Life Cycle Assessment



Life cycle assessment diagram with all stages from A-D  
 © Ministry of Business, Innovation and Employment 2022.  
 This graphic is protected by Crown copyright and reproduced from Whole-of-life Embodied Carbon Assessment: Technical Methodology under the Creative Commons Attribution (CC-BY) 4.0 International Licence

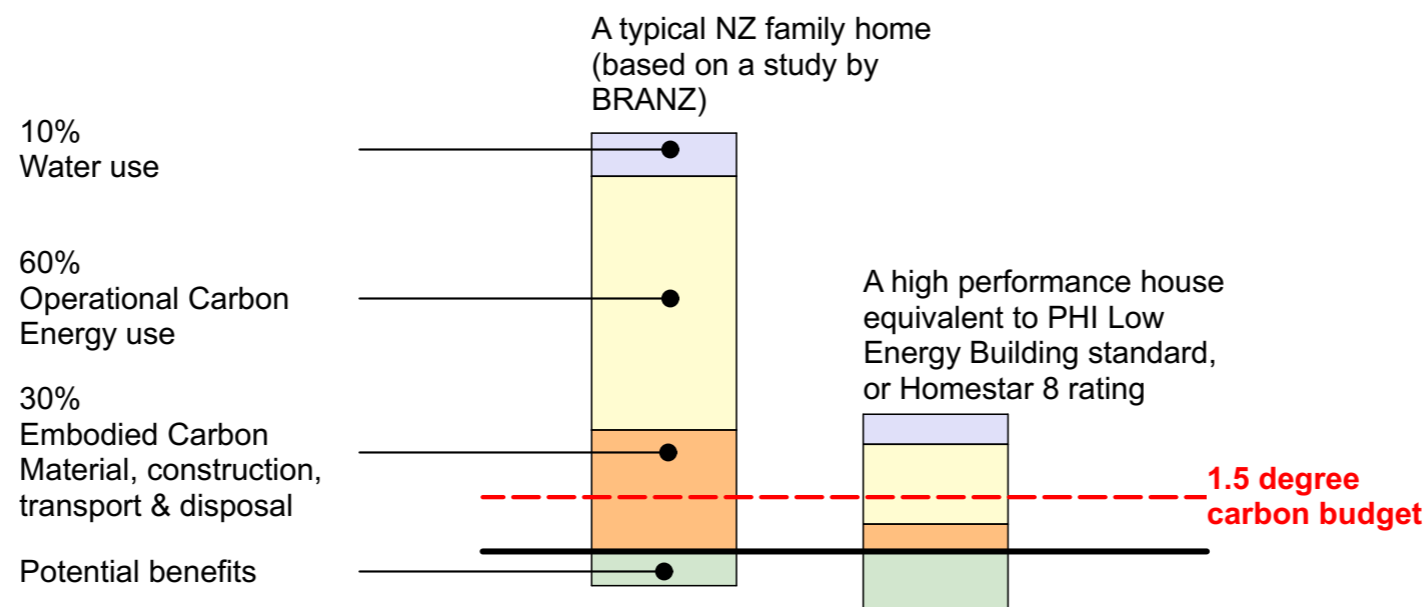

A simplified diagram of life cycle carbon emissions of a typical New Zealand house vs a small timber framed house on piles with Homestar 8 level of energy efficiency. Note this diagram is illustrative. In practice, it is difficult to achieve embodied emission reductions of this scale.

## How HECC can help us reduce embodied carbon emission

HECC (Homestar Embodied Carbon Calculator) is a tool that assesses the cradle-to-cradle life cycle embodied carbon of homes with traditional constructions (e.g. timber/steel framed homes).

It is generally suitable to be used on standalone houses and multi-unit developments that use NZS3604 type construction methodologies. Apartments or specialised structural systems such as rammed earth are beyond the capability of HECC to assess with reasonable accuracy. A more comprehensive software such as LCA Quick from BRANZ or other commercial available models, would need to be used for apartment projects.

To demonstrate the working process of using HECC to identify areas of improvements and the ways to interpret results, we have modelled the 6 Homestar version of case studies 01-03 as the baseline. Based on the results, additional effective analysis and testing in HECC is provided as worked examples.

### The 'big four'

Within any project, certain elements will often end up being the largest contributors to the embodied carbon of the building. HECC has been designed to capture seven major building systems in common residential design. Among them, the four systems in bold are often the most impactful.

- External wall (cladding, structure, insulation, finishes)
- Internal wall (structure, insulation, finishes)
- Windows (frame and glazing)
- Roofs (cladding, structure, insulation, finishes)
- Mid-floors (structure, insulation)
- Ground floor (structure, insulation)
- Floor covering

### Worked examples

The worked examples in the next three pages will take you through the carbon reduction considerations, comparison, and analysis from different angles and depths using our case study buildings.

For almost all the case studies, the embodied carbon during the use stage (B) contributes more to the building's carbon footprint than A1-A5, mainly due to the operational energy they require (or lose). Other materials are carbon intensive because of their short service life which means they may need to be replaced a number of times during the building's lifespan - for instance floor coverings such as carpet, or steel cladding in highly corrosive environments.

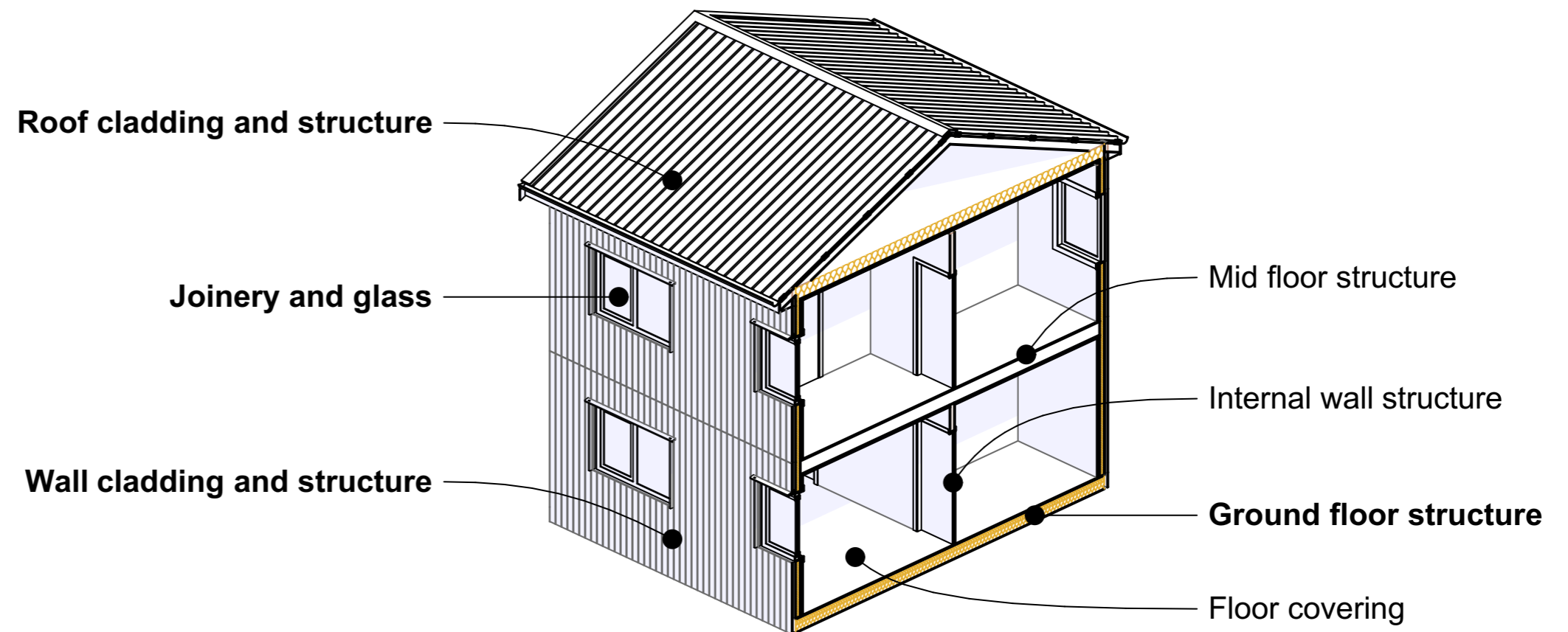



## Case study 1 and 2 results and comparison

### Case study 1 HS6

Structure: Timber frame subfloor, floor, wall, and roof  
 Cladding: Timber weatherboard  
 Roofing: Profiled metal roofing on trussed roof  
 Joinery: Thermally broken aluminium with low-e argon filled double glazing

#### Results, and potential improvements:

- Case study 1 has a very low total embodied carbon emission and a good result when it is quantified in  $\text{kgCO}_2\text{-e/m}^2$ .
- The main contributing factors of this is the extensive use of lightweight, renewable materials, and modest window sizing.
- With the limitations of HECC and the exclusion of biogenic carbon, we lack options to further improve the embodied carbon emission for case study 1. To achieve a better result (closer to the 1.5 degree carbon budget), a more detailed calculation on [LCAquick](#) or similar should be performed to, reflect specific material selection and [EPD](#) data etc.

### Case study 2: 6 Homestar

Structure: Fully insulated concrete footing and slab, timber wall and roof  
 Cladding: Same as case study 1  
 Roofing: Same as case study 1  
 Joinery: Same as case study 1

#### Results, and potential improvements:

- Case study 2 has a higher carbon footprint overall and per  $\text{m}^2$ , compared to case study one.
- The inclusion of the attached garage is the main driving factor. > Consider a carport instead?
- The concrete slab is the second most impactful difference. > Consider lower carbon concrete?
- This typology has larger window areas relative to floor area than Case study 1 and careful consideration of window area and orientation is required.

### Comparison

These two homes are the same basic building, but with some key differences, primarily the addition of a garage, more glazing area, and a concrete slab as opposed to a suspended timber floor. The results of the two carbon models show the impacts these decisions have made:

- Total climate change impact stages A1 to A5 increased 86.35%
- Climate change impact intensity increased 44.8%
- For these two dwellings you would receive 1 point for each under EN2 for doing the embodied carbon modelling.
- Case Study 1 would receive additional 2 points for being less than  $132\text{kgCO}_2\text{-e/m}^2$
- Case Study 2 is over the minimum target of  $156\text{kgCO}_2\text{-e/m}^2$

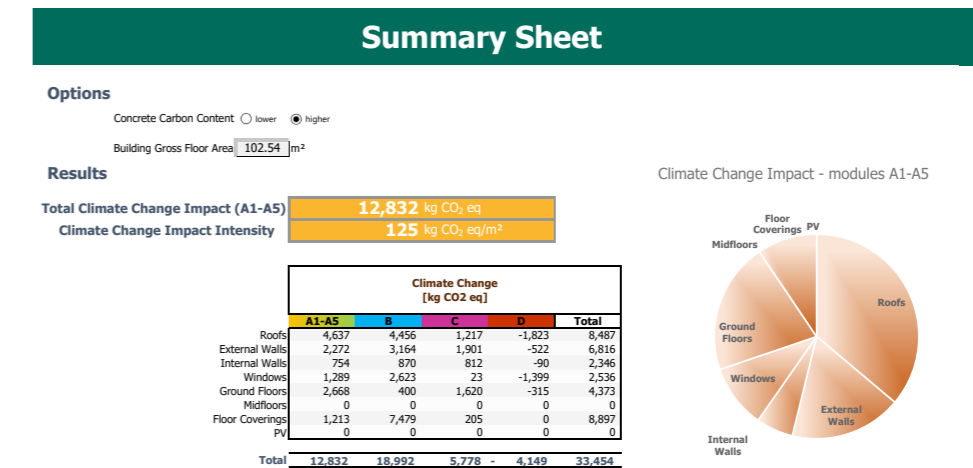

Case Study 01 - embodied carbon results, Homestar 6 specification

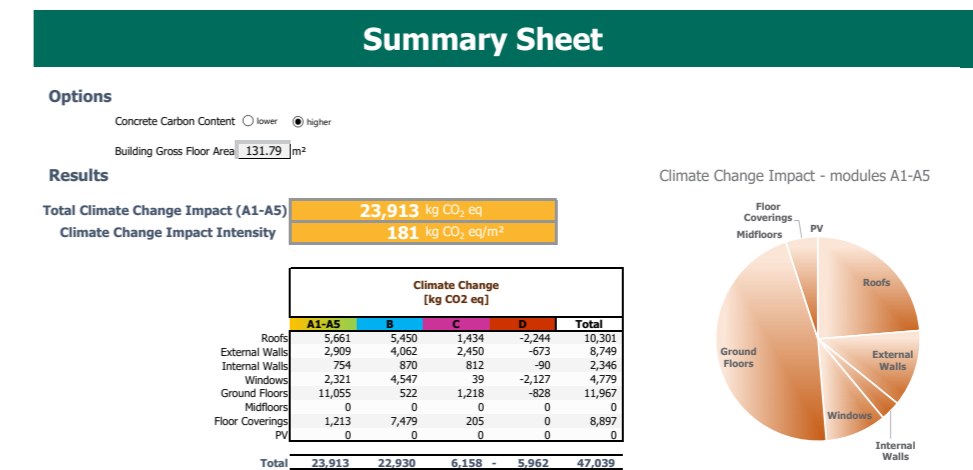

Case Study 02 - embodied carbon results, Homestar 6 specification

Approach	Points
Full lifecycle assessment, modules A-D of EN 15978	1 point

Additional points are based on the predicted cradle-to-gate and construction stage emissions (modules A1-A5 of EN 15978). Maximum points are awarded for homes that reduce A1-A5 emissions below  $60\text{kgCO}_2\text{-e/m}^2$ .

Percentage increase on emissions target	Materials and construction stage (A1-A5) emissions: $\text{kgCO}_2\text{-e/m}^2$	Points
<160%	156	1 point
<120%	132	2 points
<80%	108	3 points
<40%	84	4 points
NZ residential carbon budget required to limit global warming to 1.5°C.	60	5 points

## Case study 3 results and ways to improve

### Case Study 3 current design

- Structure: Insulation on top of conventional concrete slab, two storey timber wall and roof
- Cladding: Brick on ground floor and profiled metal on first floor
- Roofing: Profiled metal roofing on trussed roof
- Joinery: Thermally broken aluminium with low-e argon filled double glazing

### Results, and potential improvements:

- The external wall, including the cladding is the most dominant source of embodied carbon. > Consider a less carbon intensive cladding material
- The conventional concrete slab is the second largest source of embodied carbon. > Consider fully insulated raft slab system to reduce the use of concrete.

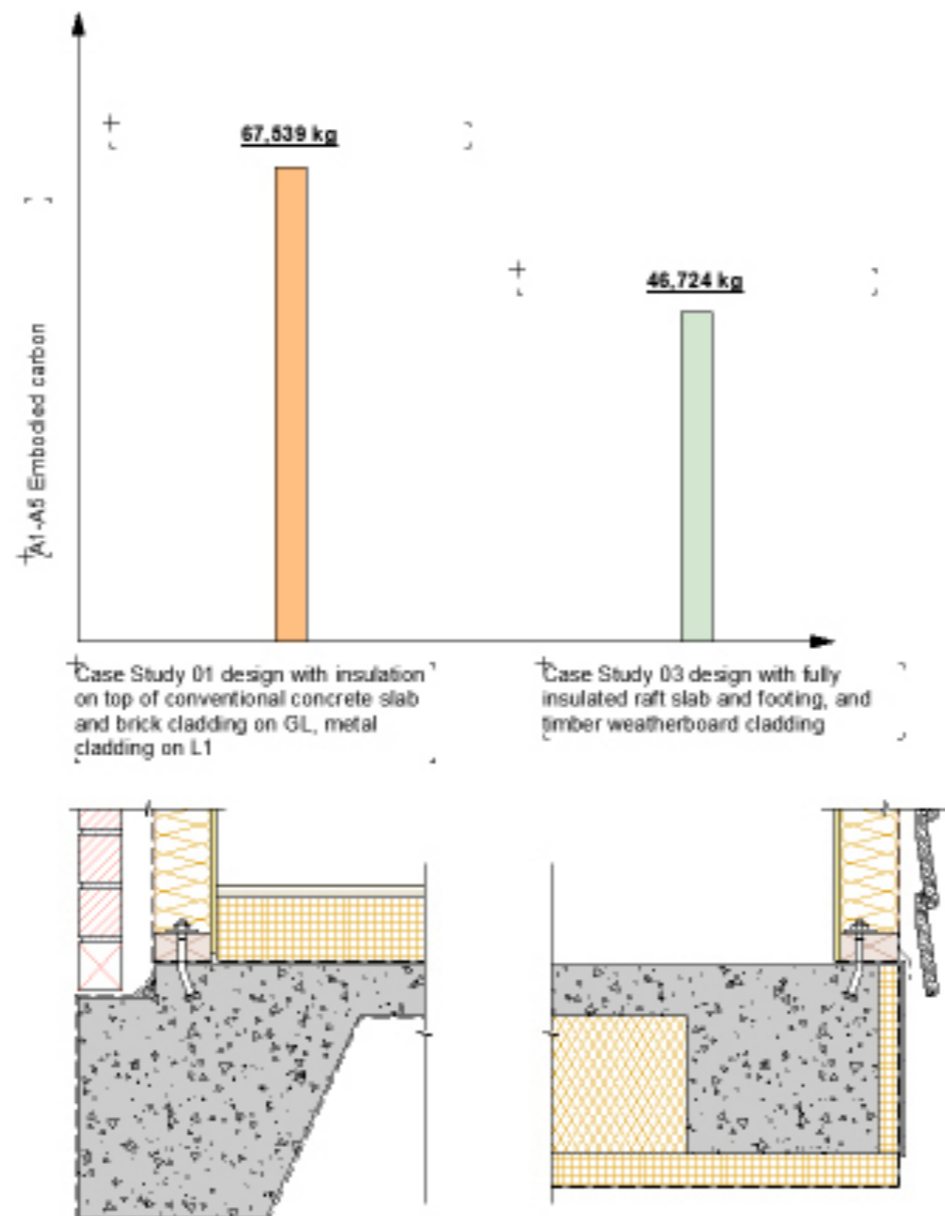

### Comparison

By simply changing the wall cladding and foundation/slab systems, the results of the two carbon models show the impacts these decisions have made:

- Total climate change impact stages A1 to A5 decreased 31%

For these two versions of the same dwelling, the current design would receive 1 point under EN2 for doing the embodied carbon modelling, but only the carbon optimised design would receive any additional points - 2 points for being less than 132kgCO<sub>2</sub>-e/m<sup>2</sup>

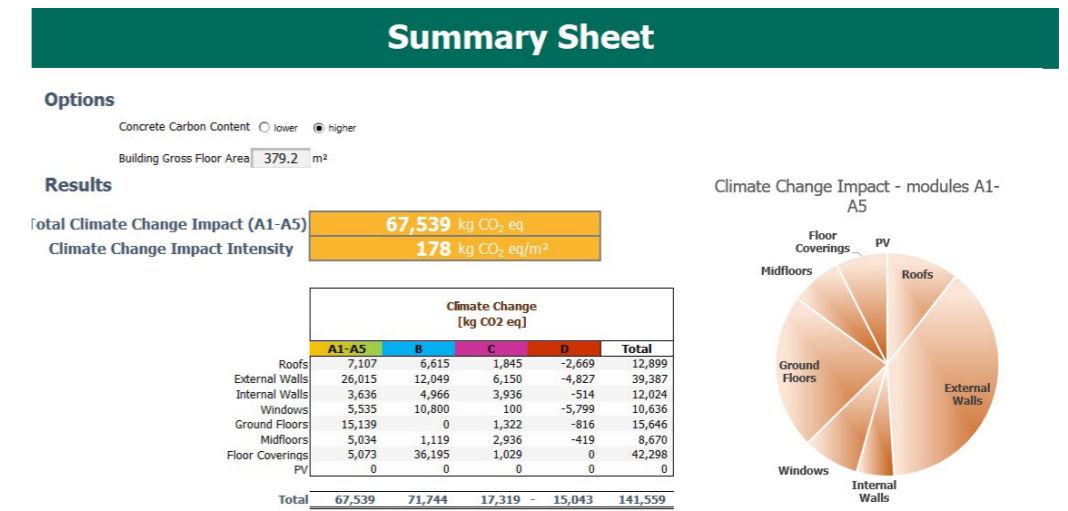

Case Study 03 - Current design

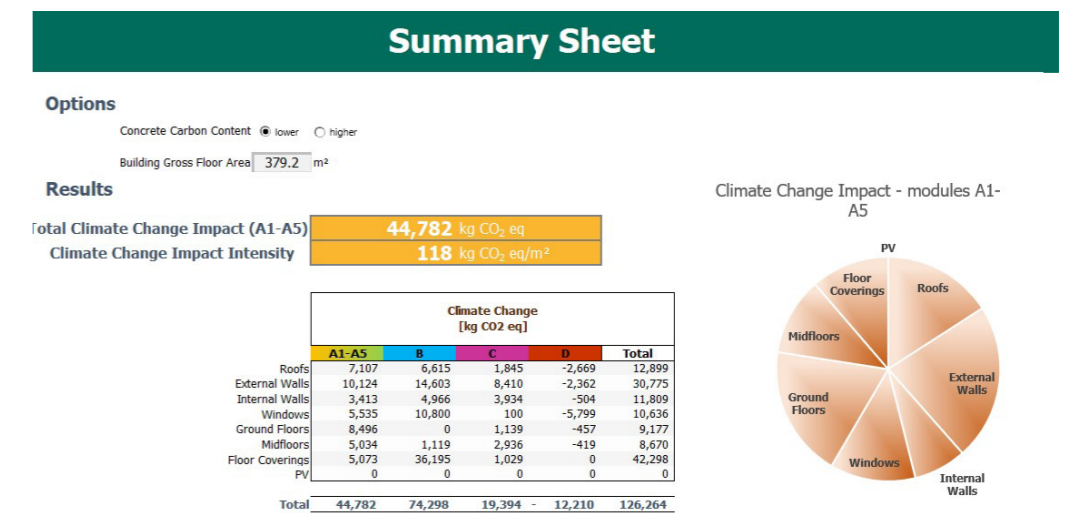

Case Study 03 - Carbon optimised design

## Additional analysis based on case study 1

In the HECC model for case study 1, we tested a few big ticket items and organised a comparison table on the right, to show the impact of the different decisions. Based on these findings, we can compile different design decisions together to reduce the overall carbon impact of the project.

The diagram below demonstrates the comparison between the CS1 design with a suspended timber floor on piles and timber weatherboard cladding vs the same design with a conventional concrete slab and brick cladding. The difference in embodied carbon emission is more than double.

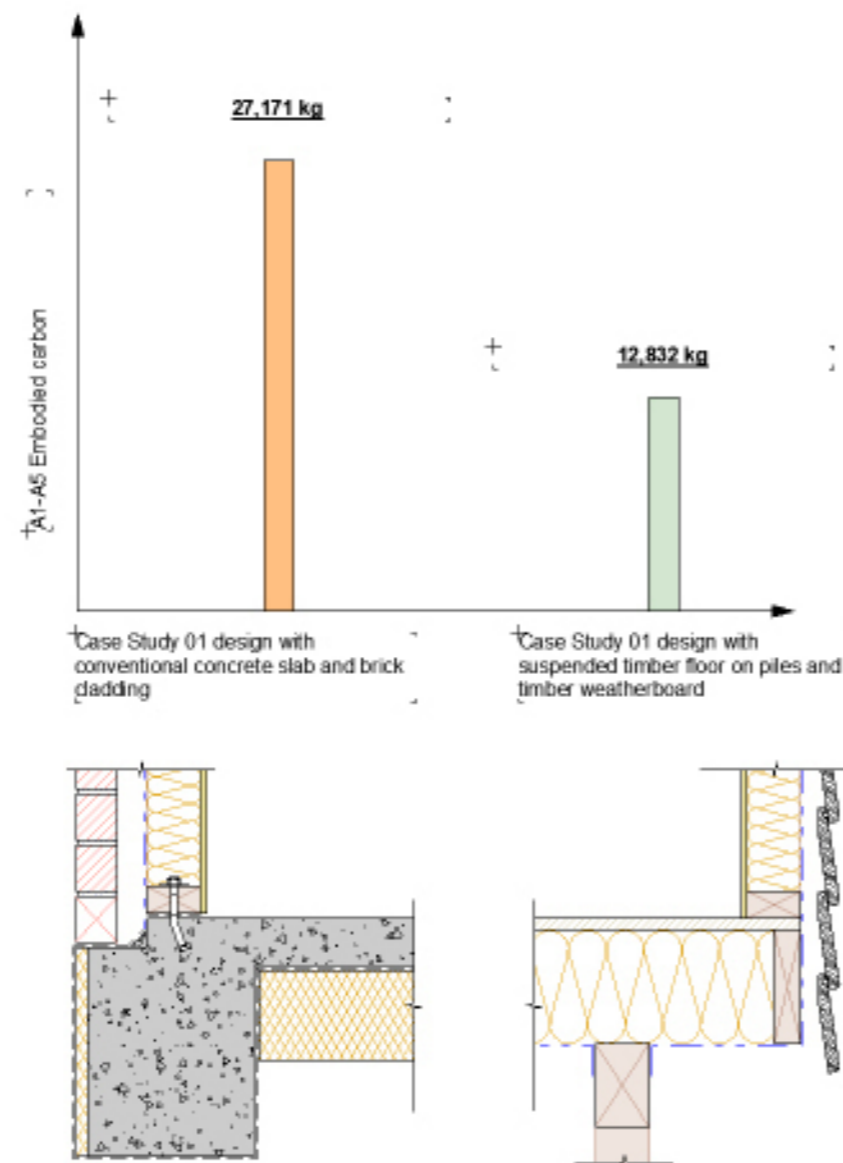

### Additional analysis based on case study 01.

The following comparisons demonstrate the potential impact on the embodied carbon that some common design decisions can have, when assessed in HECC.

- Case Study 1 HS6 vs HS8 according to the main spec table in the case study

HS6	HS8
12,832 kg	13,261 kg
125 kg CO <sub>2</sub> eq / m <sup>2</sup>	129 kg CO <sub>2</sub> eq / m <sup>2</sup>
Included option	3.2% increase in A1-A5 emissions

Note: The increase is primarily due to the increase of insulation material used. Embodied carbon of building services is not calculated in HECC.

- Floor structure comparison

Suspended timber	Conventional (NZS3604) slab with perimeter and under slab insulation	HPCD slab with fully insulated EPS formwork	HPCD slab with 100mm XPS on top of conventional slab
2,668 kg	7,471 kg	5,826 kg	7,282 kg
Included option	37% increase	25% increase	36% increase

Note: Lower carbon concrete can be an effective way to reduce the carbon footprint for slab foundation. However, they are not available from all concrete plants. Therefore, the LCA assessment for this design guide is all based on conventional concrete.

- Wall structure comparison

Timber frame with timber weatherboard cladding	Steel frame with timber weatherboard cladding	20 series concrete masonry wall with EIFS insulation finish
2,239 kg	3,961 kg	12,891 kg
Included option	13% increase	83% increase

- Window type comparison

Thermally broken aluminium Low-e argon filled double glazing	uPVC frame Low-e argon filled double glazing
1,289 kg	1,310 kg
Included option	0.1% increase

- Cladding type comparison

Timber framed wall with timber weatherboard	Timber framed wall with metal cladding	Timber framed wall with fibre cement cladding	Timber framed wall with 70mm brick veneer
2,239 kg	4,406 kg	3,640 kg	6,818 kg
Included option	17% increase	11% increase	36% increase

## On-site greenhouse gas emissions

The last carbon associated credit is the on-site greenhouse gas emissions in EF4: Energy Use. This is also the only mandatory minimum requirement related to carbon emission in Homestar v5.

### Why focus on energy use?

Despite Homestar buildings achieving higher level of energy efficiency, where the energy comes from still matters a lot. For example, the total heating demand of a house can be fulfilled by a diesel boiler or an electric heat pump; they come with very different ongoing carbon emission. Therefore, this mandatory credit aims to aid New Zealand's energy transition goal, by encouraging efficient space heating/cooling and hot water heating devices that are powered by renewable energy.

### What sources of energy?

#### 1. Fossil fuels

Although Homestar does not explicitly state fossil fuels cannot be used, it is nearly impossible to meet this mandatory criteria for all case studies when fossil fuels are used as an energy source. A typical example to avoid is using gas for cooking and hot water.

#### 2. Heat pumps and their refrigerant

Most heat pumps provide excellent COP, which helps lowering the annual electricity demand in ECCHO. However, some refrigerants used can be a significant source of on-site greenhouse gas emissions through annual and end-of life leakage. Some older generation refrigerants have the GWP (global warming potential) of nearly 2000 times worse than natural refrigerants like CO<sub>2</sub>.

### Refrigerant Leakage

Estimate leakage from refrigerants in your project here.

Add new refrigerant system

Description	Refrigerant type	Refrigerant GWP (kg.CO2e/kg)	Refrigerant charge (kg)
How water heat pump	HFC-134a	1300	0.85
Small air to air single heat pump	HFC-32	677	0.7
Large hydronic heat pump	HFC-410A	1924	5.5
CO2 Air to water heat pump	R-744	1	1.15

## General rule to achieve the targets

### 6 Homestar space heating:

- Stick to heat pumps with R32 / HFC-32 refrigerant, which is already the most commonly used refrigerant in New Zealand.
- Avoid oversizing the heat pump where possible, to minimise the amount of power required.

### 6 Homestar hot water heating:

- No attention is needed if an electric hot water cylinder or instant electric hot water heater is used.
- Follow Homestar 8 guidelines below if a hot water heat pump is used.

### 8 Homestar space heating:

- Consider using low GHG refrigerants in heating, at least R32.HFC-32, but better still move to natural refrigerants such as R744 - CO<sub>2</sub>.
- Avoid oversizing the heat pump.
- Pay close attention to the weight/volume of the refrigerant charged. Larger heat pumps or ducted heat pumps tend to use a larger quantity of refrigerant, which creates higher onsite greenhouse gas emissions.

### 8 Homestar hot water heating:

- Pay close attention to the type of refrigerant used. A heat pump with CO<sub>2</sub> refrigerant would result in lower on-site greenhouse gas emissions, but tend to be more costly.
- Pay close attention to the weight/volume of the refrigerant charged. If the refrigerant type has high GWP but there is a small amount of it, the criteria of 2 kgCO<sub>2</sub>-e/m<sup>2</sup> may still be met.

Maximum onsite greenhouse gas emissions (kg.CO<sub>2</sub>-e/m<sup>2</sup>) associated with space heating, hot water and refrigerants for all climate zones:

6 and 7 Homestar	8, 9 and 10 Homestar
4	2



# The avoidance of overheating



**HC2: Summer Comfort**



**HC3: Ventilation**

# Fundamentals of overheating

The indoor temperature starts rising when the net heat gain exceeds the net heat loss. When the temperature exceeds 25 degrees celsius, it is defined as overheating in ECCHO and the Homestar Summer Comfort credit. The maximum allowable frequency of overheating is represented as a percentage of the year for each star band.

Sources of heat gain include

- ☑ Solar gain through windows, walls, and roof on sunny days
- ☑ Internal heat gain (occupants and appliances)

Sources of heat loss include

- ☑ Transmission heat loss through floor, wall, roof, and windows
- ☑ Natural ventilation
- ☑ Ventilation systems and uncontrolled air leakage

In this design guide, we will focus on some effective ways of reducing overheating.

1. Shading design
2. Glazing selection
3. Summer window ventilation

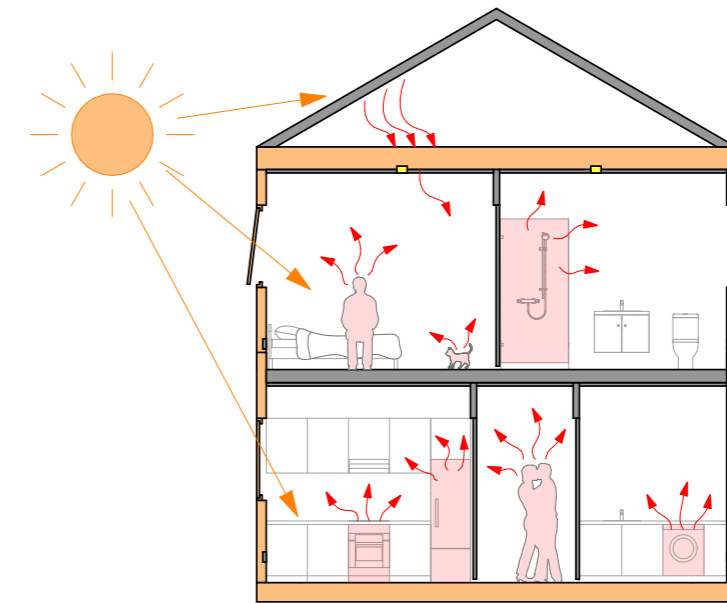

Heat gain sources

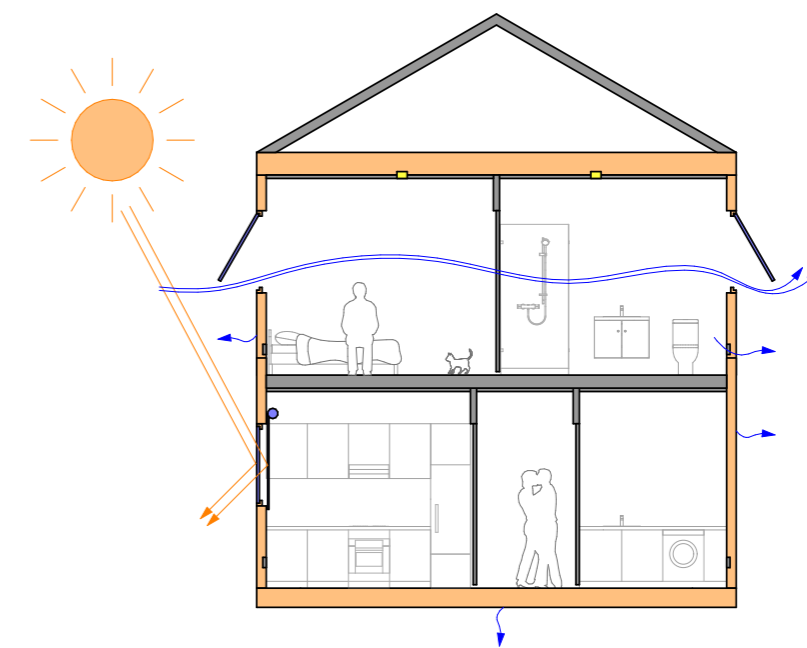

Heat loss sources

## Shading - its importance and how to quantify it

Shading can have a significant impact on the performance of a building. We rely on certain levels of 'free' solar gain from the sun to reduce the amount of additional energy required to heat the building up. If there is something blocking the sun - a mountain, a tree line, a fence or a neighbouring building for example, we are getting less 'free' heat, so need to add more energy.

The other side of this is overheating - in summer we will likely need to reduce the amount of solar gain to prevent the building getting too much heat energy, which will result in overheating. To this end, correctly understanding the amount of shading related to the site is very important.

### Site shading

Site shading generally refers to shadows cast by the surrounding terrain, neighbouring buildings, landscape features on the horizon. Urban plots will contend with neighbouring buildings, and future buildings around it, as well as fences, gardens, etc. Rural plots will likely have fewer buildings, but more forests, bush, mountains and hills.

We can assess this shading with a variety of tools:

- ✔ Site photos - scale trees, buildings and immediate surroundings
- ✔ Google Earth Pro - to find the horizon shading using a path
- ✔ Topographical surveys & council maps.

Using a combination of these we can usually make a reasonable approximation of the surrounding shading levels. However, with more complex sites it may be necessary to utilise other software to assess the shading - PHPP, DesignPH or dynamic modelling software for example.

### Self shading

Self shading generally refers to shadows cast by the building itself including, but not limited to, building form, wing walls, external shading screens, etc.

Note: Overhangs are technically a form of self-shading, although these are calculated separately in ECCHO. Overhangs are most effective to the north. Sun angles to the east and west are relatively lower, therefore overhangs are less effective.

Note: Fixed louvres and screens are calculated as part of self-shading.

### Window treatment

Window treatment generally refers to blackout internal blinds and curtains. External blinds are generally excluded in Homestar due to the variety of the external blind types and fabric perforation.

Window treatment can work well, but due to their reliance on occupant behaviour can't be as relied upon, compared to an effective self-shading design. For this reason we only allow a slight improvement with the installation of the blinds. Any design that fails badly for overheating will not pass solely by the installation (or use) of blinds.

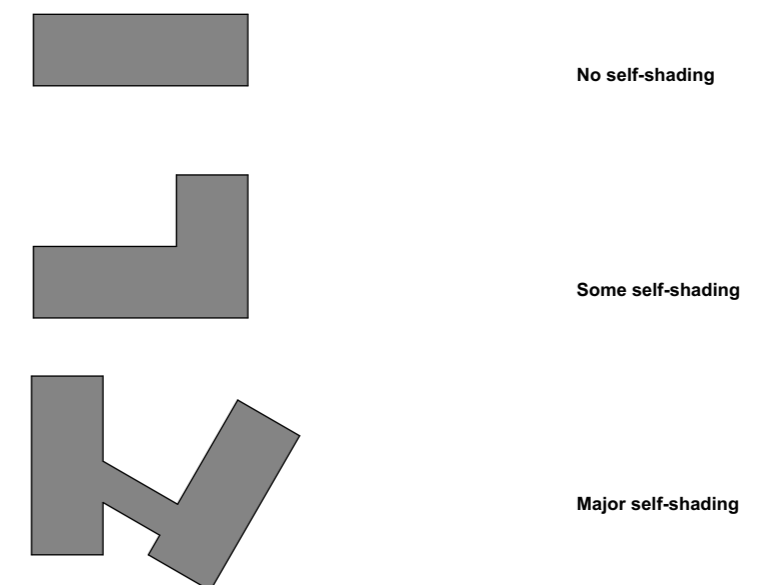
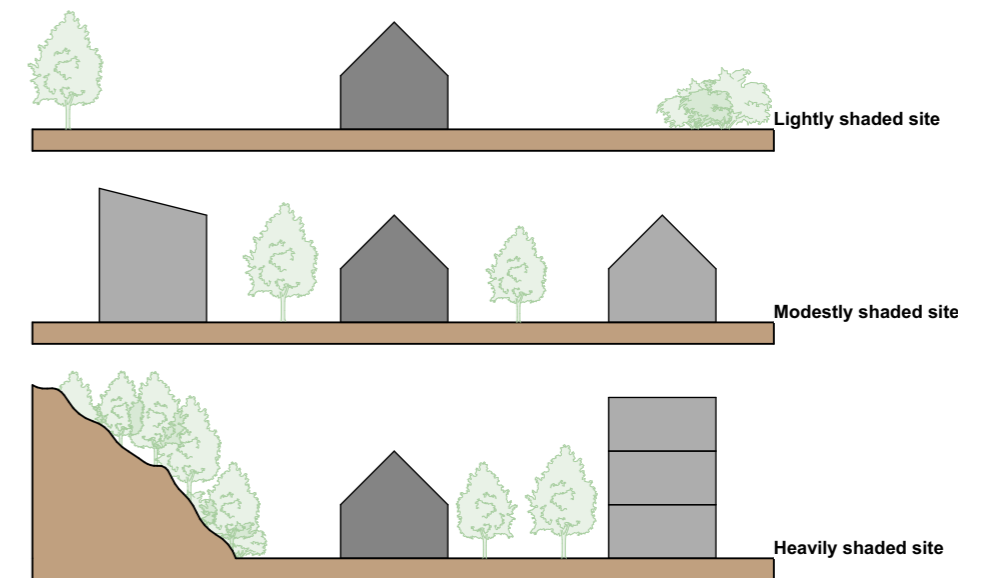

## Accounting for shading in ECCHO

ECCHO has two inputs to help quantify the amount of shading on glazing, which are included in the dialogue for each window and door:

### 1. Overhang (calculated window by window)

The way to quantify overhangs is documented in Homestar v5 technical manual. Simply enter the “shading depth” and “shading height” of any soffits, balconies, etc above each unit according to the manual guidelines, so that the correct amount of overhang shading is calculated for each joinery unit.

### 2. A reduction factor for winter and summer as a percentage

This refers to the amount of sunlight that isn't prevented from reaching the building by surrounding buildings, trees, hills, etc.

The reduction factor default values are 80% for winter and 90% for summer. However these figures are quite approximate and don't allow for higher or lower levels of shading in different site contexts, or more complex building forms. Using these can result in less accurate heat gain and overheating results, which can lead to incorrect design decisions, e.g. an over reliance on natural ventilation or the incorrect choice of the type of low-e glass. If this happens, the end user comfort can be significantly impacted.

The following tables and worked example in this chapter aim to help Homestar professionals meet the overheating targets, and make better decisions on shading design.

To better estimate shading in ECCHO, we can break the single percentage down to three categories:

- A:** Site shading – terrain, neighbouring buildings, landscape feature
- B:** Self-shading - building form, wing walls, shading screen
- C:** Temporary shading (summer only) – Internal window treatment - including this is optional

We can then use these three categories to calculate more accurate shading percentages:

**Winter sun admitted (%) = A% X B%**

**Summer sun admitted (%) = A% X B% X C%** (optional)

The table on the following page provides percentages for each category.

The joinery input dialogue box from ECCHO



## ECCHO shading percentage categories

Site shading					
Lightly shaded		Modestly shaded		Heavily shaded	
Winter	Summer	Winter	Summer	Winter	Summer
90%	100%	80%	90%	70%	80%
Typical cases: - Houses in an open field without large hill or dense bush around - Upper storey apartments with the surrounding building being the same height or lower		Typical cases: - Houses or multi-unit dwellings in a neighbourhood with similar types of housing next door. - Middle storey apartments with other 3-storey apartments across the street		Typical cases: - Single story house with 2-storey neighbouring buildings or established trees around. - Ground floor apartment with other 3-storey apartments across the street	
Note 1: Site shading generally has smaller impact in summer due to higher sun angle. Overhang, on the contrary, has greater impact in summer typically. Note 2: Typical site shading reduction factors are sourced from multiple PHPP energy models based on the 4 case study buildings in different site context.					

Self-shading		
Box form	L-shape form or similar	Complex form
100%	90%	80%
Typical case: - Houses or multi-unit dwellings that are simple, rectangular shape without additional shading screen. - Most apartment units	Typical cases: - Houses or multi-unit dwellings that are not in rectangular form. - Single sided apartment units with recessed balcony	Typical cases: - Houses with pavilions and links - Any building type with extensive use of shading screen
Note 1: Typical self-shading reduction factors are sourced from 3 DesignPH models, certified by Sustainable Engineering, to best reflect the average reduction factor for each level of complexity.		

Temporary shading (summer only)	
White outer facing internal blind or curtain on double low-e argon filled glazing	White outer facing internal blind or curtain on triple low-e argon filled glazing
60%	70%
Note 1: window treatment with other colours may not be quantified using ECCHO as the shading effect is largely dependent on the darkness. Note 2: window treatment must be installed and verified during Built Rating if temporary summer shading is included in ECCHO. Note 3: Typical temporary shading devices with insulated triple and double glazing are sourced from PHPP_10_EN_Manual and modified to provide conservative reduction factors.	

## Worked example 1

Case study 02 is in a subdivision with similar houses as close as 4m to the rear, but further away on the front and sides.

There are some established trees but no dense woodland or bush. The house's attached garage means the form is considered similar to an L shape. Internal blinds are proposed on the bedroom windows to block the full moon, or sun in daylight hours.

- ✎ Winter % for all windows =  $80\% \times 90\% = 72\%$
- ✎ Summer % for bedroom windows =  $90\% \times 90\% \times 60\% = 48.6\%$
- ✎ Summer % for other windows =  $90\% \times 90\% = 81\%$
- ✎ Overhang = as per calculation window by window

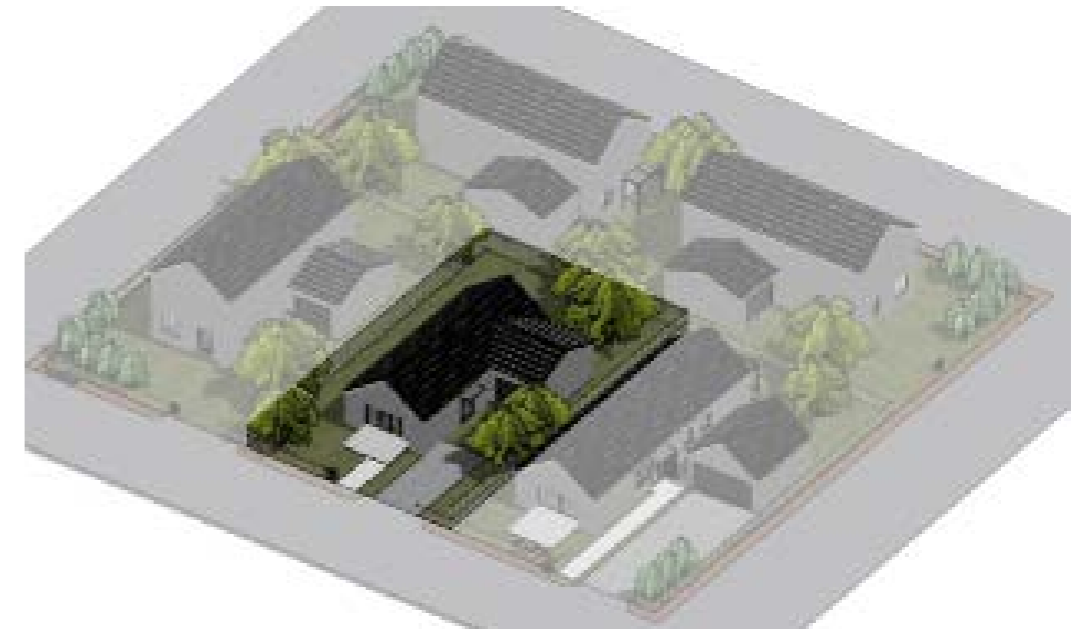

## Worked example 2

Case study 04 is in a new medium density zone, with other 3-storey walk-up apartments across the street, and across a large courtyard or car park.

Each apartment unit is considered as a rectangular shape with little to no self-shading effect on most windows. Internal blinds are proposed on all windows for privacy reasons.

- ✎ Winter % for ground level units =  $70\% \times 100\% = 70\%$
- ✎ Winter % for first floor units =  $80\% \times 100\% = 80\%$
- ✎ Winter % for top floor units =  $90\% \times 100\% = 90\%$
- ✎ Summer % for ground level units =  $80\% \times 100\% \times 0.6\% = 48\%$
- ✎ Summer % for first floor units =  $90\% \times 100\% \times 0.6\% = 54\%$
- ✎ Summer % for top floor units =  $100\% \times 100\% \times 0.6\% = 60\%$
- ✎ Overhang = as per calculation window by window

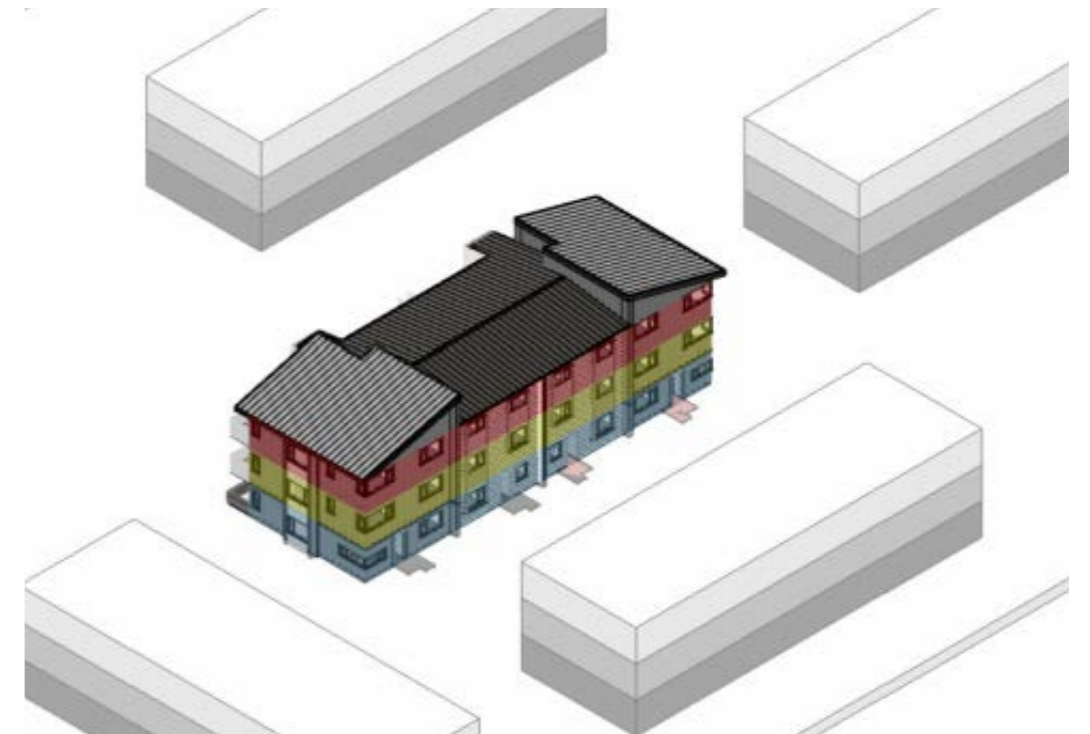

## Glass selection

### Low-e coatings, edge spacer, filled gas

The glass in your windows can have a large impact on your overheating levels in summer. Low-E coating to the glass reduces solar gain from the outside and increases the reflection (preservation) of infrared (heat) from the inside. Despite Low-E glass always achieving better overall energy balance compared to conventional glazing, it does limit the solar gain in winter as well. This must be tested in ECCHO to help inform the optimal balance for it to passively enhance your summer and winter comfort.

Considerations for overall glazing performance:

#### g-value

- Higher g-value = more solar gain = good for winter but bad for summer.
- Also called the SGHC (Solar Heat Gain Coefficient) this is a shading factor that tells you how much total solar radiation the glass lets through. For example, a g-value of 0.57 will let through 57% of the solar radiation, while a g-value of 0.35 will only let through 35%.
- g-values are provided by the low-E coatings on the glass. This is a thin layer of silver or other low emissivity material, that reflects a percentage of the total solar radiation from the outside away and keeps a percentage of the total infrared from the inside within the space.
- The g-value is not tied to the amount of visible light the glass lets through (the VLT) however once you start getting to very low g-values the glass may start to appear darker.

#### U-value

- Higher U-value = lower R-value = less insulating = bad for both winter and summer
- This is the thermal performance of the glass and is a result of the space between panes, number of panes and the type of gas between the panes in double or triple glazing. Note: choosing a less insulating glass is NOT a good way to reduce overheating.

#### Filled gas

- Argon or Krypton filled glass = lower U-value = higher R-value = good for both winter and summer compared to conventional uncoated glass

#### Visible Light Transmission (VLT)

- Higher VLT = a visually brighter room
- The lower the value the less visible light will come through, although this is not proportional to the total solar radiation that comes through the glass, which is reflected by g-value.

### Edge spacer and its psi value

- Aluminium spacer = higher heat loss = condensation around glazing edge.
- Warm edge spacer = less heat loss = reduced or no condensation around glazing edge.
- The psi value is a correction factor for the thermal bridge, or overlap between the frame, the glass and the edge spacer, to account for the heat loss at this junction.

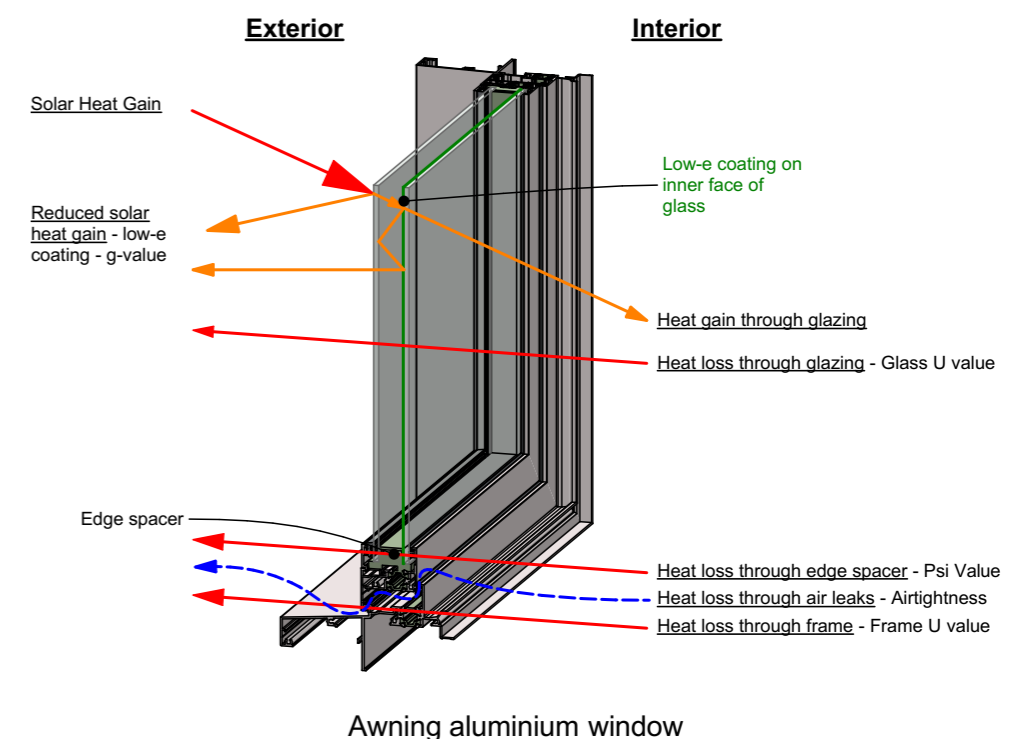
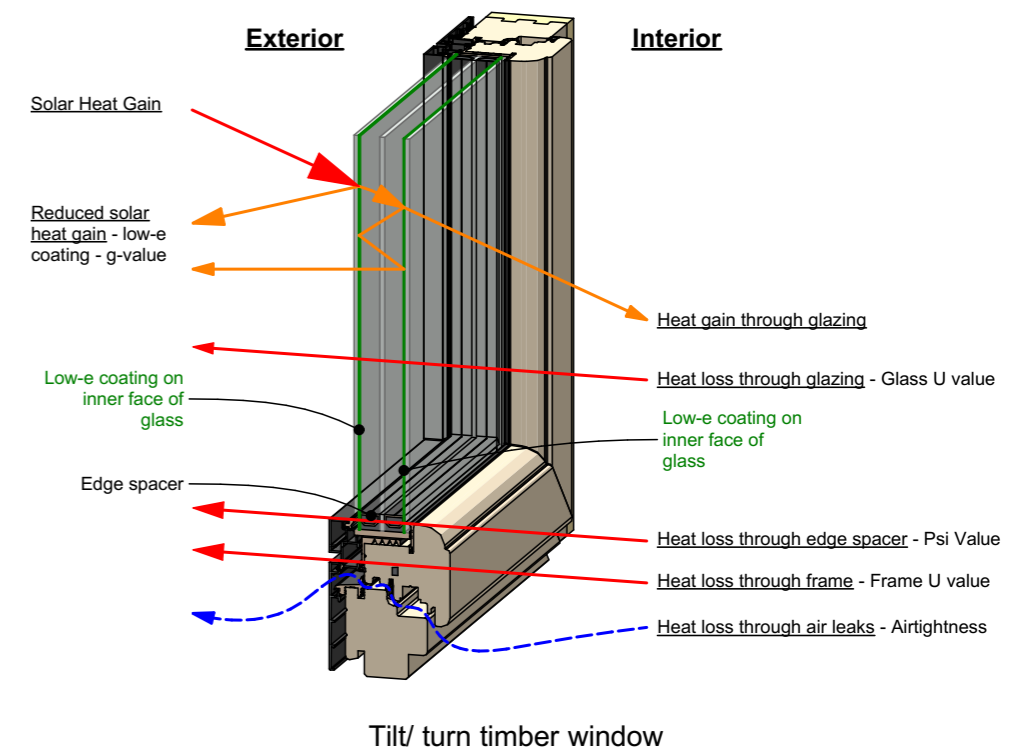

## Glass selection for each climate

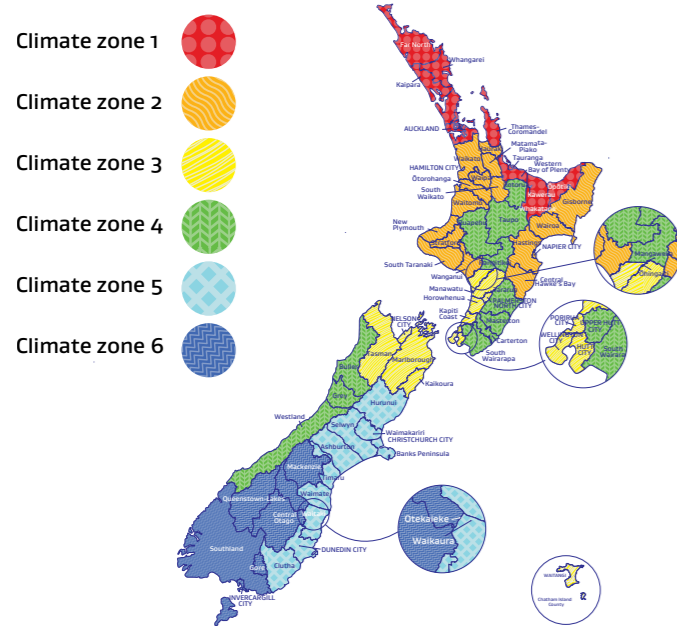

The table below shows which glazing options can be used as a starting point for preliminary ECCHO models in selected climate zones. The default glazing options in ECCHO are consistent with Table E1.1.1 in H1/AS1, which makes it easy to combine the Homestar and compliance considerations together to streamline the process. For Homestar projects with a good margin for both heating demand and overheating, the ECCHO default glazing options could be used rather than sourcing manufacturer specific data.

Type of glazing	ECCHO default equivalent	g-value	U <sub>g</sub> <sup>(1)</sup>	Spacer type <sup>(2)</sup>	Example IGU <sup>(3), (4)</sup> (informative)	R <sub>window</sub> (m <sup>2</sup> ·K/W) for different frames				Rule of thumb choices for preliminary ECCHO model
						Aluminium frame	Thermally broken aluminium frame	uPVC frame	Timber frame	
Double pane	<b>Double Lowe Arg Best</b>	<b>0.57</b>	1.30	Thermally improved	Glass: Low E <sub>3</sub> /Clear Gas: Argon	R0.35	R0.46	R0.63	R0.71	<b>HS6 for Climate Zone 1-3</b>
	<b>Double Lowe Arg Exceptional</b>	<b>0.54</b>	1.10	Thermally improved	Glass: Low E <sub>4</sub> /Clear Gas: Argon	R0.37	R0.50	R0.69	R0.77	<b>HS6 for Climate Zone 4-6 HS8 for Climate Zone 1-3</b>
	<b>Double Lowe Krypton</b>	<b>0.37</b>	0.90	Thermally improved	Glass: Low E <sub>4</sub> /Clear Gas: Krypton	R0.40	R0.54	R0.76	R0.85	<b>May be triggered by overheating requirement in any climate</b>
Triple pane	<b>Triple Lowe Arg Best</b>	<b>0.47</b>	0.70	Thermally improved	Glass: Low E <sub>3</sub> /Low E <sub>3</sub> /Clear Gas: Argon		R0.59	R0.86	R0.95	<b>HS8 for Climate Zone 4-6</b>
	<b>Triple Lowe Arg Exceptional</b>	<b>0.43</b>	0.60	Thermally improved	Glass: Low E <sub>4</sub> /Low E <sub>4</sub> /Clear Gas: Argon		R0.62	R0.91	R1.01	

However this will limit the chance of achieving the optimal energy balance in both summer and winter.

Obtaining specific glazing data from manufacturers, and testing these in ECCHO, will still be necessary for any project with a higher overheating potential, or if a specific low g-value glazing is proposed.

H1/AS1 glazing table and it's ECCHO/Homestar equivalent

Low E Xtreme - Argon - Clear - Thermal Spacer

Make-up mm <sup>1</sup>	Building Code Acceptable Solution H1/AS1 Schedule (see schedule notes)				EN 673							EN410		
	Window System Material Type by Climate Zone				Ug <sup>2</sup>	Visibility			Heat Gain			SF <sup>3</sup>	SC <sup>3</sup>	LSG <sup>3,4</sup>
	Standard Aluminium	Thermal Break Aluminium	uPVC	Timber		U Value	VLT <sup>3</sup>	VLR-E <sup>3</sup>	VLR-I <sup>3</sup>	Solar Factor (g)	Shading co-efficient			
4-16-4	Zones 1-6 Stage One	Zones 5-6 Stage Two	Zones 5-6 Stage Two	Zones 5-6 Stage Two	1.0	75%	14%	14%	41%	0.47	1.87			
4-18-4	Zones 1-6 Stage One	Zones 5-6 Stage Two	Zones 5-6 Stage Two	Zones 5-6 Stage Two	1.1	75%	13%	14%	40%	0.46	1.87			

### Edit glazing type

Save and close

Description: Metro Low-e Xtreme 4/16/4

U<sub>glazing</sub>: 1.0

g value: 0.41

How to create your own glazing option in ECCHO based on glazing manufacturer's datasheet



## Summer window ventilation and night purging

As discussed in the [ventilation chapter](#), windows cannot be solely relied on to provide the minimum required ventilation. Nevertheless, they can be used to ensure user comfort and provide additional ventilation to mitigate overheating.

During the day in summer when the exterior temperature is high and the air often humid, we don't really want to open windows and bring this in. However, they can be used to provide air movement which creates a feeling of reduced heat, and in the evenings and night when the exterior temperature drops, we can use open windows for 'night purging', that is, removing excess heat that has built up during the day.

When utilising openable windows as a strategy to reduce overheating, only units that can be fixed in an open position and avoid the rain coming in can be included in the calculation, as per clause 1.2.3 of G4/AS1. In most cases, doors cannot be included in this area, as while they may be utilised by occupants, they are not weatherproof when open, cannot usually be fixed open, and are a security risk if left open overnight or during unoccupied times. One of the few exceptions is doors to a fully recessed balcony on the upper floors of an apartment building. This must be agreed with NZGBC on a case by case basis.

### 1.2 Natural ventilation – General

#### COMMENT:

1. The net openable area of windows or doors is measured on the face dimensions of the *building element* concerned.
2. Fixing in an open position of doors and windows used for ventilation is necessary to avoid injury or damage from sudden closure in the event of strong winds or other forces.
3. Keeping water from entering the *building* must be considered for compliance with NZBC Clause E2 External Moisture.

**1.2.3** Openable *building elements* shall be constructed in a way that allows them to remain fixed in the open position as a means of ventilation during normal occupancy of the *building*.

Paragraph from G4/AS1 section 1.2

When designing openable windows, consideration should be given around location and security - will they provide cross ventilation; are there some low and some high; can high level windows be included, as they can be left open with fewer security risks? As per the diagrams on the right, achieving code compliance can also limit the amount of openable area available, depending on the requirements of F4/AS1 section 2.0.

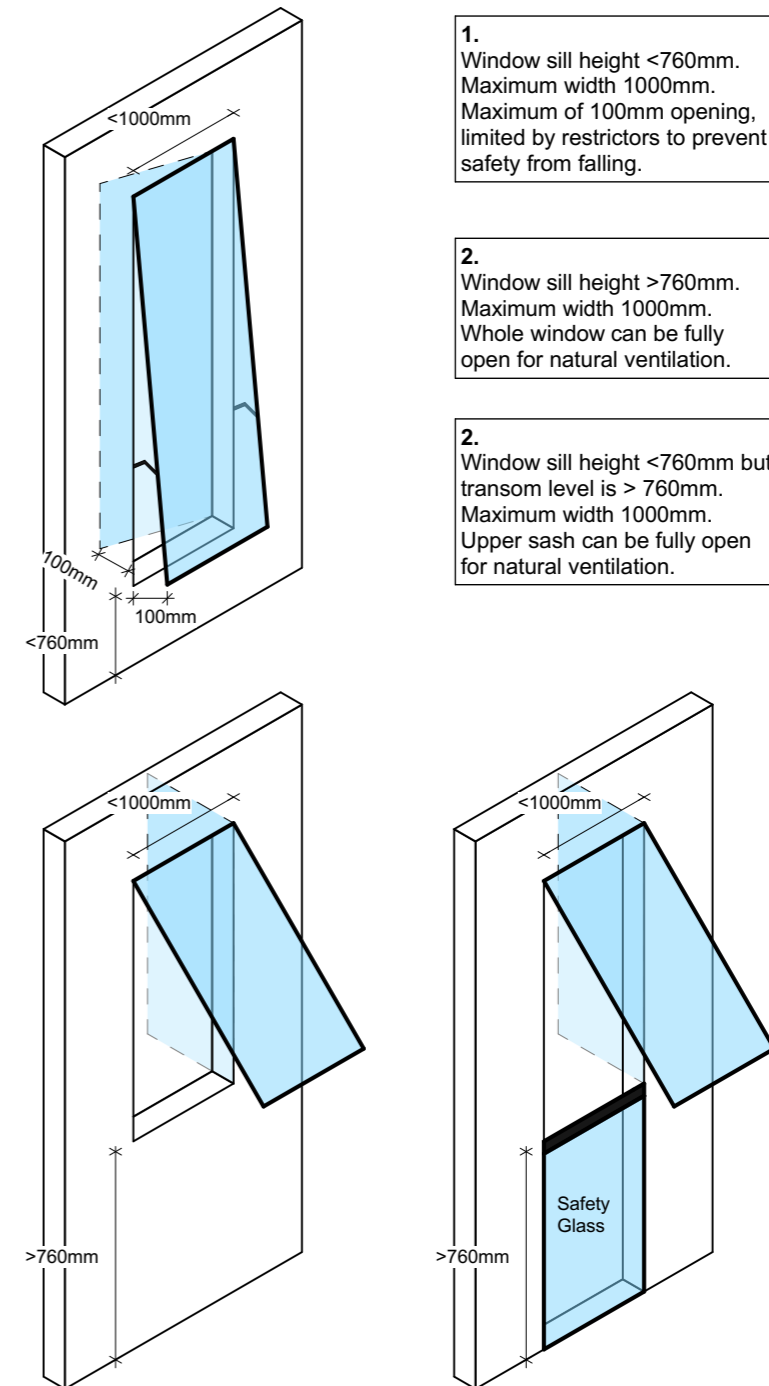

Different building types also have different opportunities and issues that will impact the effectiveness of natural ventilation.

### Single storey detached houses

These are easier to achieve sufficient summer ventilation, because most windows can be fully opened during occupied hours. They also usually benefit from more cross ventilation and stack effect scenarios.

### Two storey multi unit dwellings

These typically face some challenges for the upper level rooms as hot air rises, and the ability of natural ventilation through windows can be limited by the restrictor stays. The window configuration strategies on the previous page can help improve natural ventilation rates and reduce overheating.

### Three storey walk-up apartments

These tend to face greater challenges, especially when it comes to complying with the maximum overheating percentage for the “summer worst case unit”. This is due to less potential for site shading on upper stories to reduce solar gain in summer.

Take case study 04 as an example: the top level north facing apartment has limited shading, plenty of solar gain, but limited heat loss due to the compact form factor. Without changing the design, both careful glazing selection, potentially exterior shading, and a good natural ventilation strategy will likely be needed to ensure overheating levels are minimised.

With apartments there may also be more units where cross ventilation isn't possible, further reducing the effectiveness of using openable windows to reduce overheating.

#### 01. Single sided ventilation - apartment

Less impact from prevailing Wind

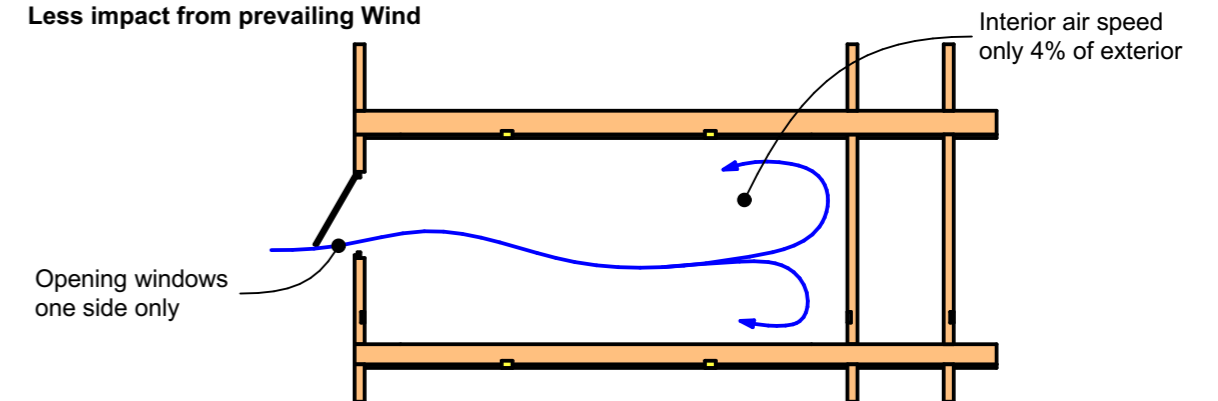

#### 02. Single sided ventilation - house/ terrace

Prevailing Wind

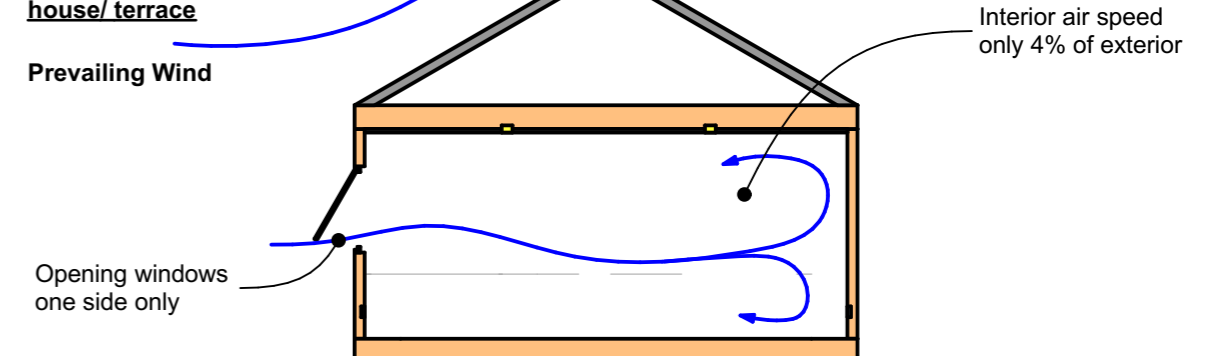

#### 03. Cross ventilation

Prevailing Wind

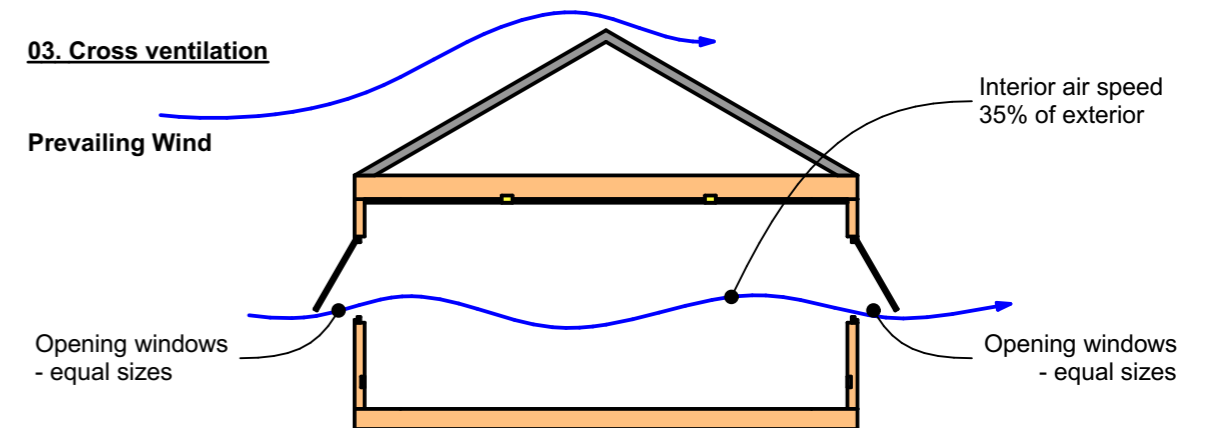

#### 04. Stack effect ventilation

Prevailing Wind

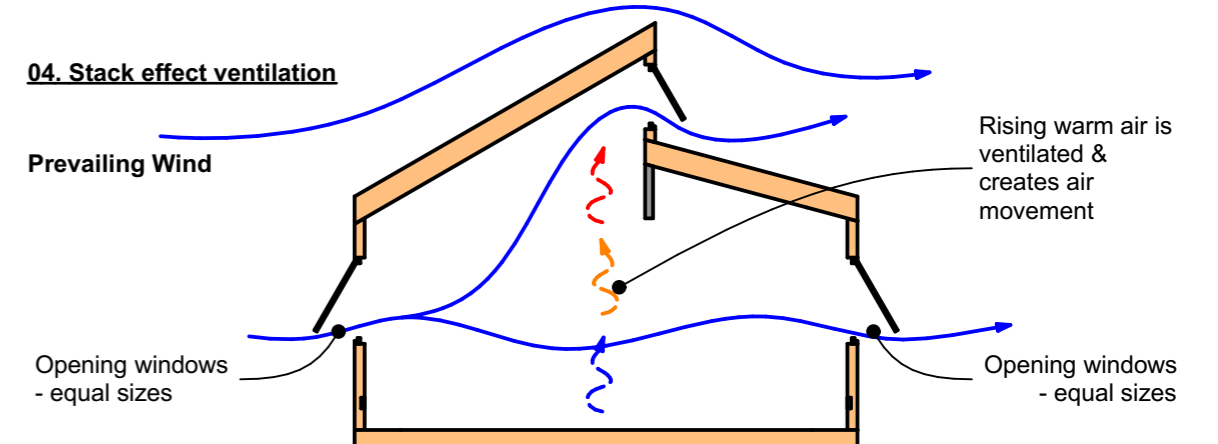

## Overheating - other impacts

There are a range of other elements that can impact overheating in a building, which aren't expressly included in ECCHO and Homestar at this stage, but should be considered:

### Climate change and heat island effect

In our warming world, higher exterior temperatures are almost a given. When assessing the current levels of overheating based on historic climate data, bear in mind these will likely increase over time.

In urban environments with lots of buildings, footpaths, roads, etc, the ambient air temperature will be higher than if the building was surrounded by trees and grass. This is hard to quantify but we need to bear in mind.

### Colour of the cladding and roofing

Light coloured cladding and roofing will absorb less sun than dark cladding, so a light grey roof will result in less heat gain than a black roof for example.

Cladding and roofing colour has less impact on a well-insulated building - the amount of ceiling/ roof insulation can help to mitigate heat transfer from a dark coloured roof.

Overhangs can mitigate the amount of sun that will reach dark claddings and reduce heat gain.

### Internal heat gains

This refers to the heat generated within the building from appliances, cooking, showering and the occupants themselves. ECCHO makes an assumption for these based on the assumed occupancy, which is based on the floor area of the building.

This can be hard to quantify, but if the designed occupancy load is higher than ECCHO default, e.g. more people live there than the assumed amount, we can investigate further in ECCHO by using custom occupancy values.

### Active Cooling

Overheating can be managed by providing active cooling, from a heat pump for example. However, the design of the system must be assessed. A single room heat pump will usually be in the main living space, so will likely not be able to cool the bedrooms sufficiently.

A ducted heat pump system will provide the best cooling effectiveness for relatively low power use, but will likely attract a higher system and installation cost.

In some cases, air movement can mitigate the user experience of lower levels of overheating. This can be provided by ceiling fans for example.

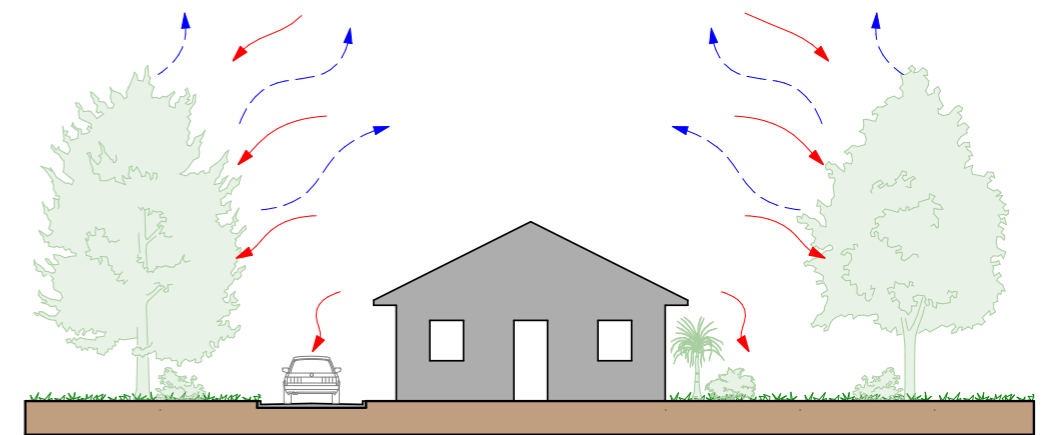
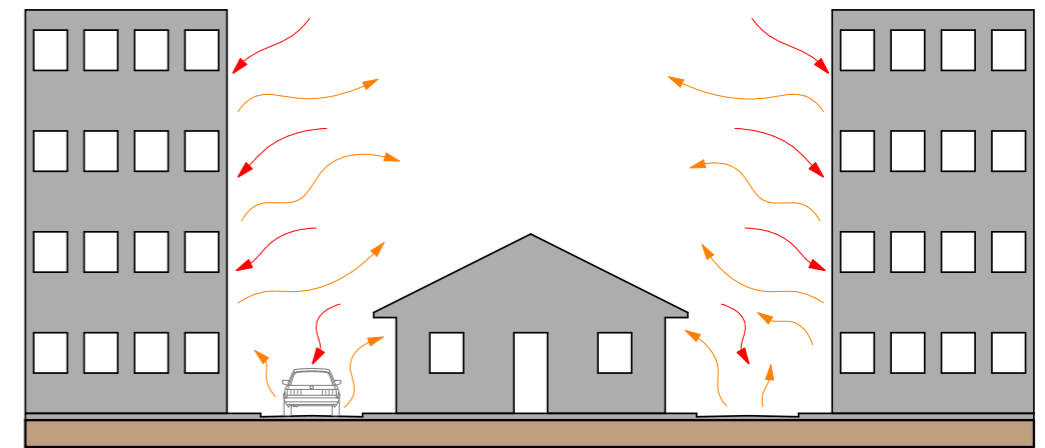

Heat island effect

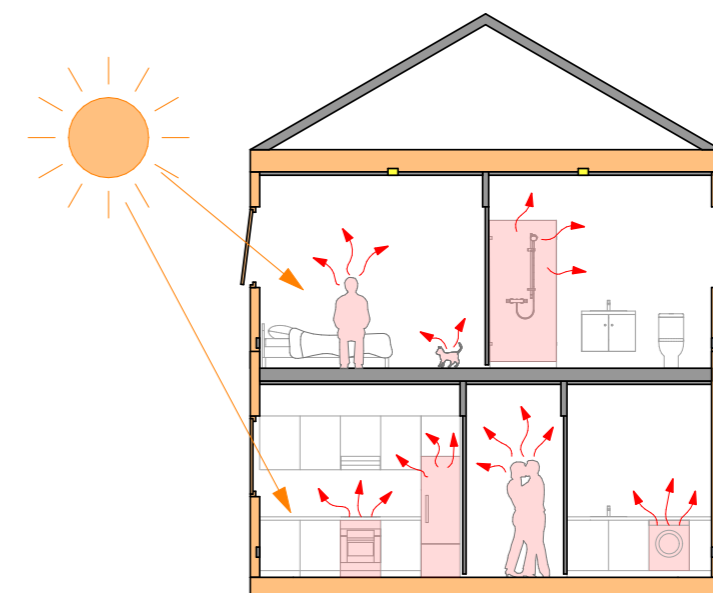

Heat gain sources

## Overheating - other impacts (cont.)

### **Mechanical Ventilation with Heat Recovery (MVHR) bypass**

- ✎ Most balanced mechanical ventilation systems, which include heat recovery, also include a 'summer bypass'. This means that during summer when you don't need to retain excess heat, the air will bypass the heat exchanger so no heat is recovered.
- ✎ This can help remove excess heat during the night, but during the day in summer when the exterior air temperature is higher, the incoming air temperature will still be warm.

### **Thermal mass**

- ✎ Relying on thermal mass to reduce overheating is not recommended. Thermal mass can work in principle, but it requires precise window sizing and whole-year shading design analysis in BIM model. Without this level of analysis, thermal mass often absorbs too much heat during summer days and causes overheating in the evening. In winter, thermal mass often receives insufficient heat and makes heating the room harder.
- ✎ Materials with higher thermal mass such as concrete tend to be highly heat conductive. When thermal mass is part of the thermal envelope, it must be fully insulated. Without continuous insulation, thermal mass would act like a leaky battery and can compromise thermal performance throughout the year.
- ✎ Thermal mass within a well insulated thermal envelope and that does not receive direct sunlight has better potential to ease temperature fluctuation in both winter and summer with no knock on effect.



# Controlling the interior environment

 **HC1: Winter Comfort**

 **HC2: Summer Comfort**

 **HC2: Summer Comfort**

 **HC3: Ventilation**

©NZGBC 2024. NZGBC has presented the following guidance to promote better building standards and methods. The Homestar® name, logo or Homestar® rating specifications may only be used in relation to an application for or obtaining Homestar® certification. Projects that claim to meet the requirements of NZGBC rating schemes but are not certified are potentially in breach of trademark rules and may be accused of 'greenwash'.



# Controlling the interior environment

New Zealanders spend around 70% of their time indoors, during which time they cook, shower, sing, breathe, and generally live! While they do this they are producing excess moisture and CO<sub>2</sub> and if the levels of either get too high this can cause health issues for people, and issues for the building fabric itself.

At the same time, many elements within our buildings are 'off gassing' as they age, leading to volatile organic compounds (VOCs) being released into the air - that new sofa smell, or the smell of paint for example. Many of these can become harmful to people if they reach certain levels.

Studies have shown that relying solely on openable windows rarely, if ever, provides adequate ventilation to keep a building and its inhabitants healthy. To this end openable windows should only be utilised for user comfort, with the minimum required levels of ventilation catered for separately.

The best way to do this is to provide continuous mechanical ventilation, where one or more fans create airflow to remove the moisture, CO<sub>2</sub>, VOCs and other pollutants in the air. For this reason, continuous mechanical extract ventilation is the minimum requirement for all Homestar levels.

The three main types of mechanical ventilation:

- ✔ Positive pressure
- ✔ Negative pressure
- ✔ Balanced pressure

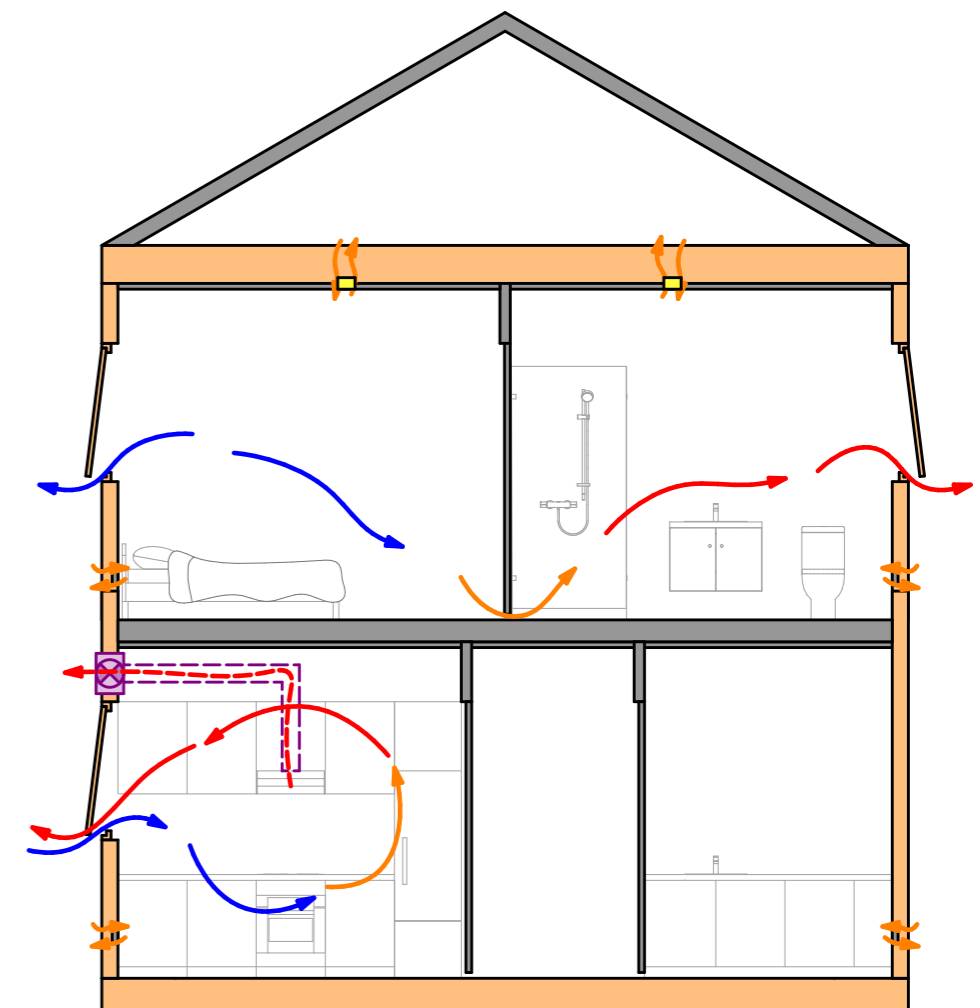
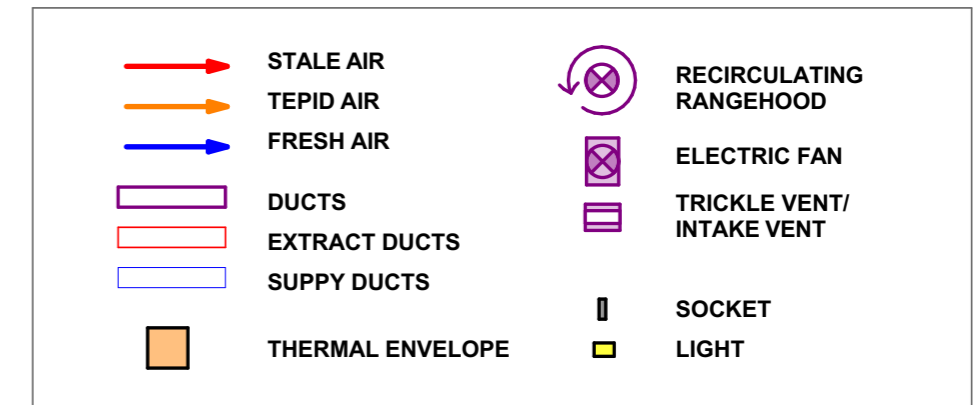

Natural Ventilation

## Positive pressure

These systems use fans to push air into the building, pressurising it. The air is then forced out of the building through any gap it can find – potentially an open window, but in an air leaky building this could be plug sockets, light fittings and walls, windows, ceiling and floor junctions. Moisture is forced into the building fabric, creating potential interstitial condensation risks.

While previously accepted in other countries, positive pressure systems are slowly being phased out, with Britain, for instance, no longer accepting them as an acceptable solution.

With many of the systems available in New Zealand, the air is also extracted from the roof space, with no guarantee of air temperature or quality.

Positive pressure systems do not satisfy the ventilation requirements in Homestar and BRANZ recommends air is sourced from the outside for ventilation purposes.

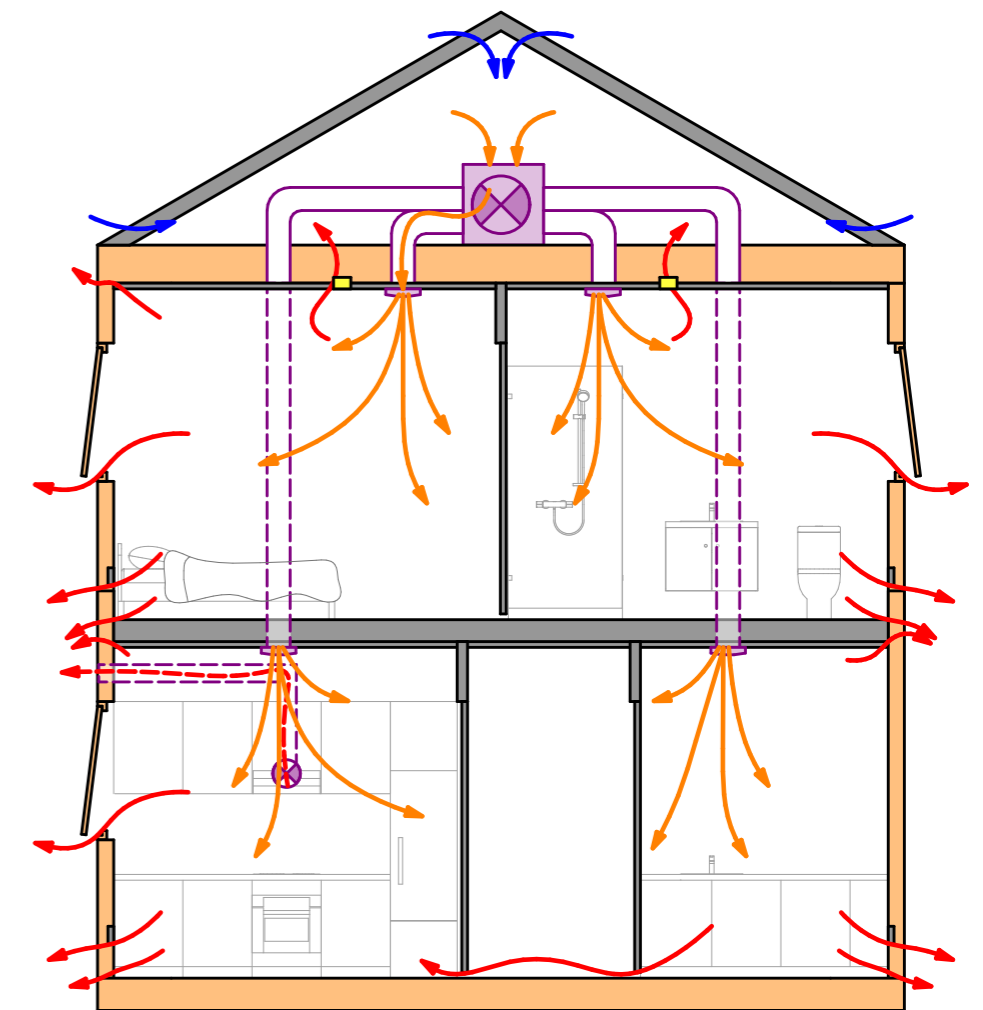
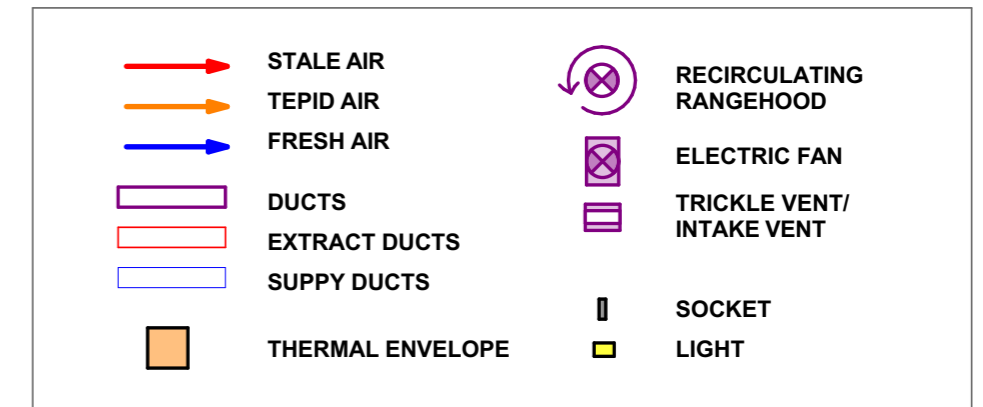

Positive Pressure

## Negative pressure

Negative pressure systems are the opposite, using fans to remove the air within the building and depressurise it, pulling make up air into the building through trickle vents and open windows, but also any gaps in the building fabric if the supply vents aren't suitably sized, or open. Examples are bathroom fans and kitchen extracts ducted to the exterior.

This is less risky than positive pressure systems and it will help to remove moisture and VOCs. But design needs to ensure that all areas of the house benefit with careful positioning of the fans and vents. Include sufficient 'make up' air to replace the air extracted from the building. This should not rely on openable windows, so trickle vents in the joinery, or specific in-wall vents should be included.

Negative pressure systems can be ducted or decentralised. The important point is that the fan needs to be sized to work continuously

and at reduced noise levels. Intermittent fans do not meet the Homestar ventilation standard, and can create mould issues from moisture not being extracted sufficiently through ducts to the outside.

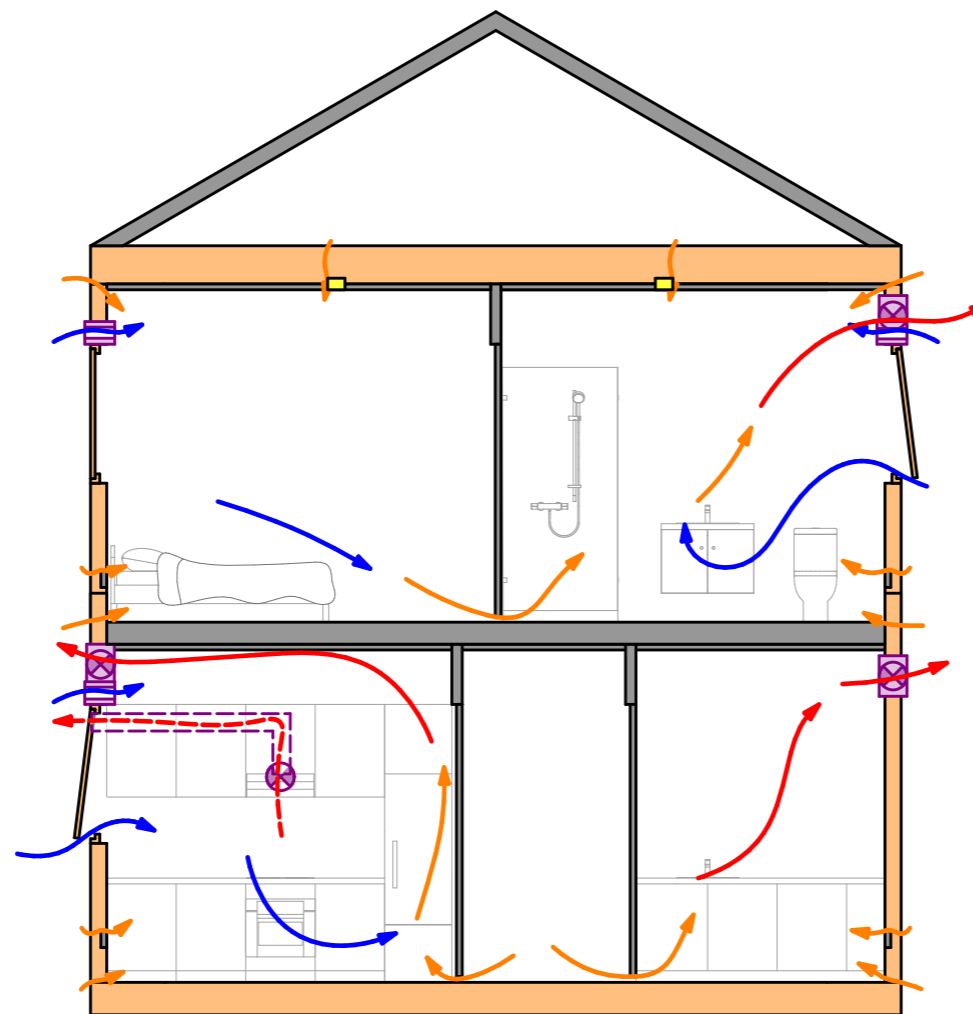
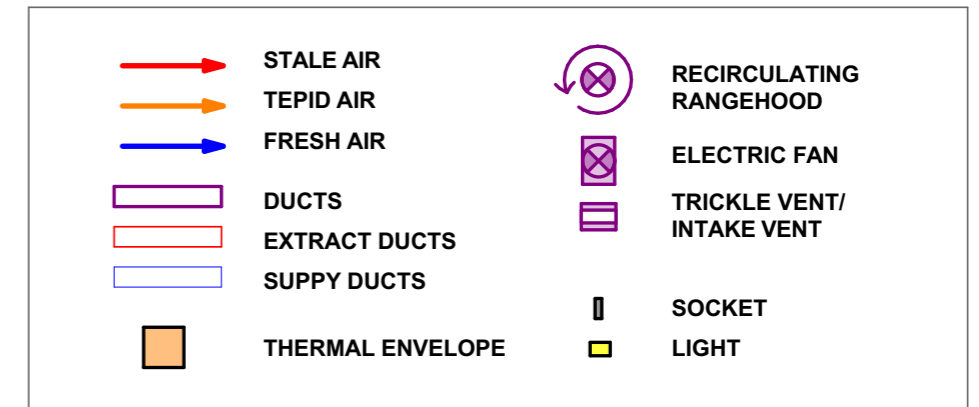

Negative Pressure - Decentralised

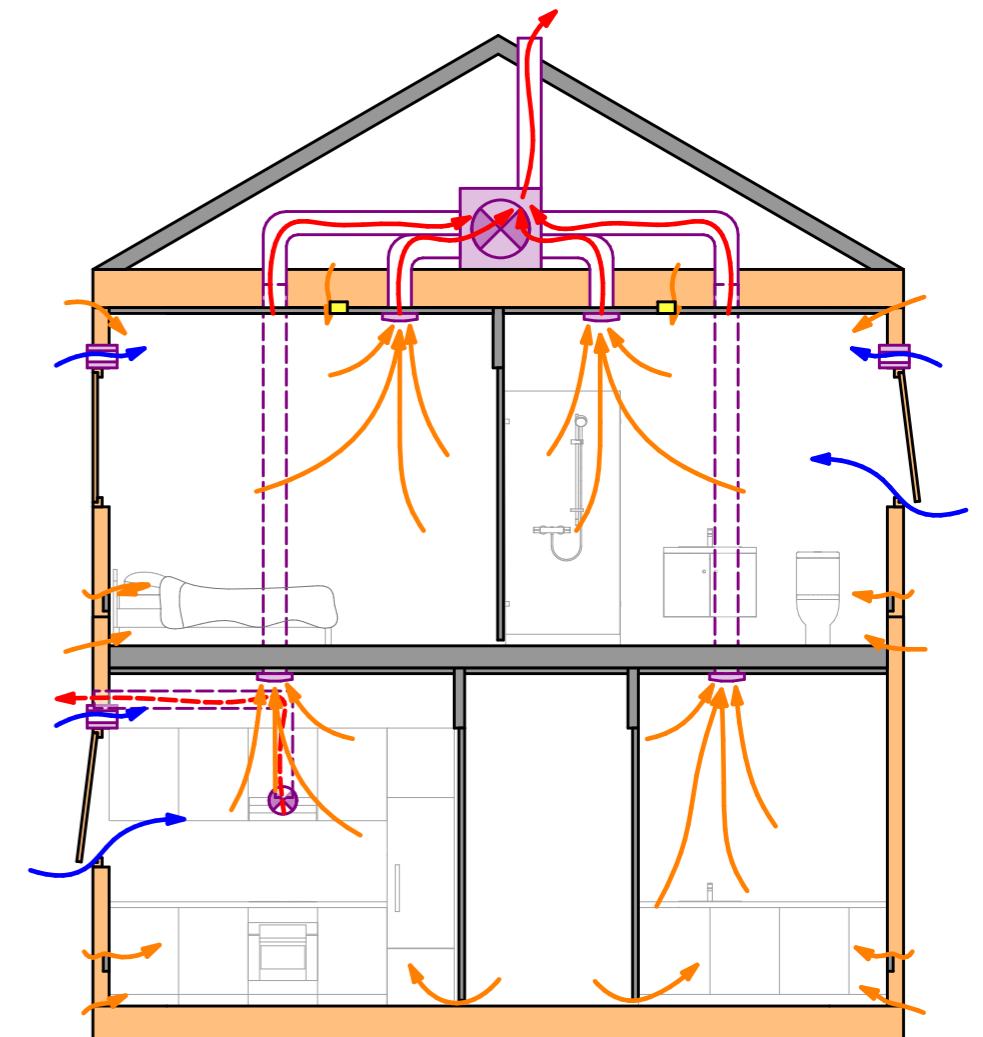

Negative Pressure - Centralised



## Balanced pressure

A balanced pressure ventilation system uses two fans to bring in the same amount of air as it removes. This ensures there is no additional pressure on the building envelope. Balanced pressure systems are the recommended solution for new homes. They can come with heat exchangers that recover waste outgoing heat and preheat the incoming fresh air (in winter - and the opposite in summer).

The following recommendations are largely to do with optimising the performance of negative and balanced ventilation systems in order to meet Homestar criteria.

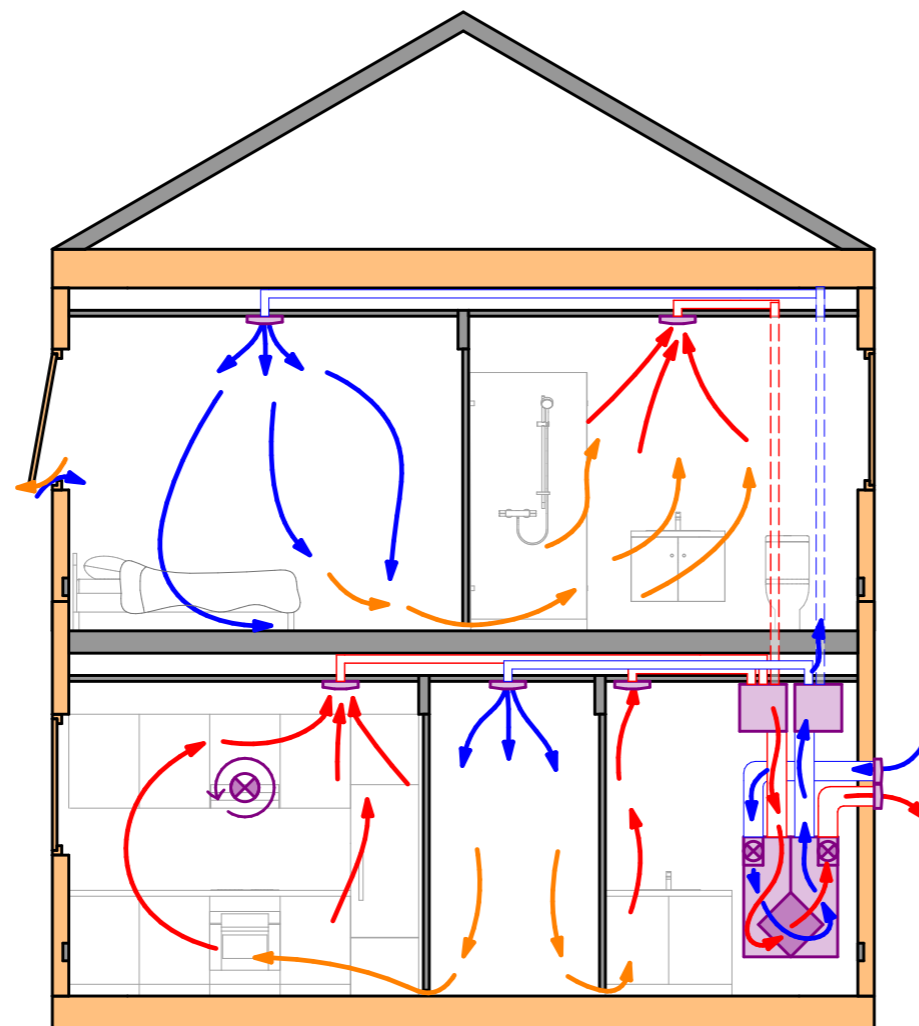
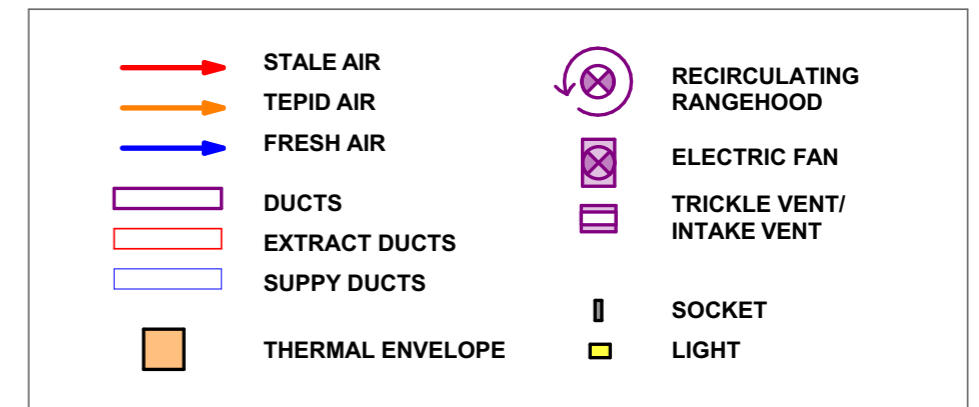

Balanced Pressure + Heat Recovery - Centralised

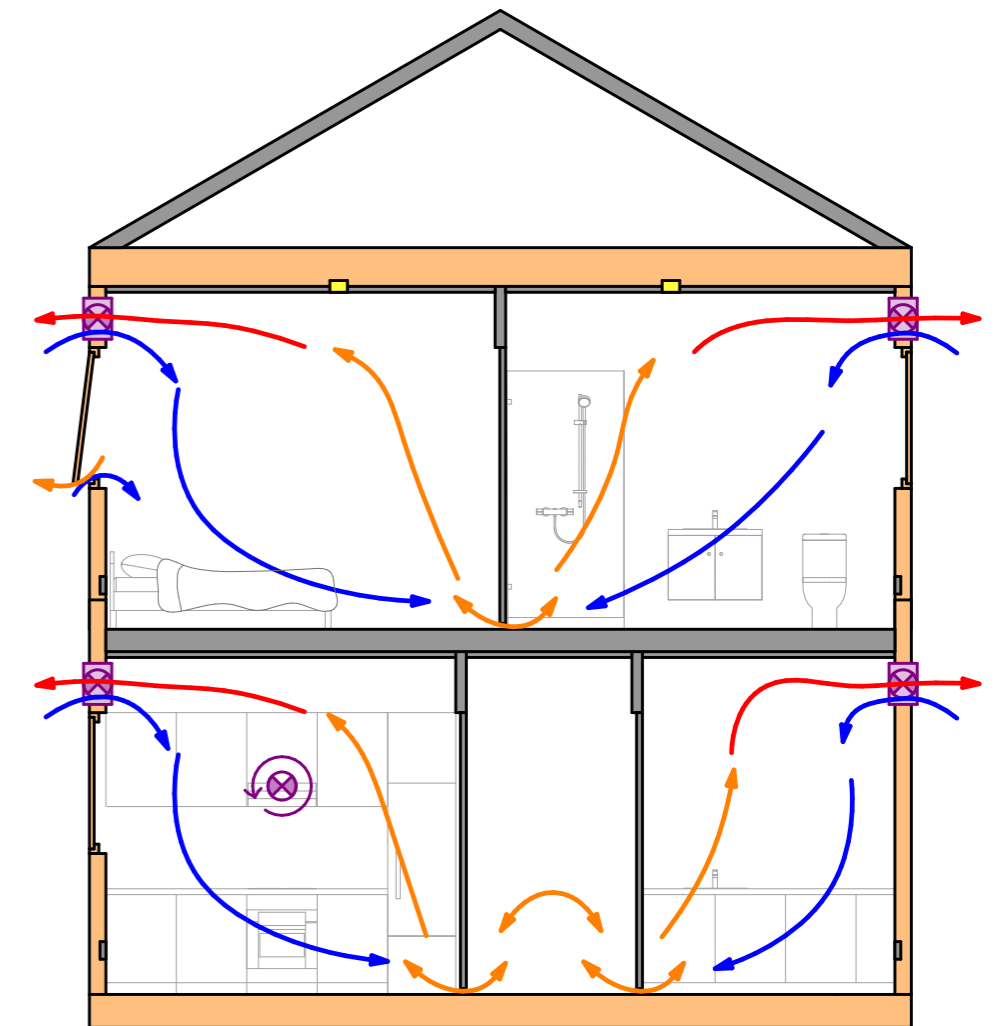

Balanced Pressure + Heat Recovery - Decentralised

## Ventilation system design considerations

Ventilation system design is not as straightforward as adding in a few fans - each system will need its own design considerations. For most, the following advice will apply, but if you're unsure it's recommended to engage an [HVAC](#) designer.

### Occupancy and flow rates

The number of people in the building dictates the amount of ventilation required, as stated in NZS 4303.1990, which says:

- ☑ Either a minimum 0.35 air changes per hour for the whole building
- ☑ Or 7.5 litres per second per person
- ☑ Whichever is greater.

If the occupancy of a building is likely to be higher, then a higher rate can be used - e.g. 0.8 air changes per hour, however **the higher the flow rate, the higher the rate of heat loss** - a balance must be found.

To comply with the New Zealand Building Code, G4/AS1 1.1.2 states:

Ventilation of spaces within buildings must be provided by natural ventilation, mechanical ventilation, or a combination of mechanical and natural ventilation

Section 1.5 covers the requirements and flow rates of mechanical ventilation, which is the section relevant to the design of ventilation systems required by Homestar, as natural ventilation is not relied on.

**TABLE 2.3'**  
**OUTDOOR REQUIREMENTS FOR VENTILATION OF RESIDENTIAL FACILITIES**  
(Private Dwellings, Single, Multiple)

Applications	Outdoor Requirements	Comments
Living areas	0.35 air changes per hour but not less than 15 cfm (7.5 L/s) per person	For calculating the air changes per hour, the volume of the living spaces shall include all areas within the conditioned space. The ventilation is normally satisfied by infiltration and natural ventilation. Dwellings with tight enclosures may require supplemental ventilation supply for fuel-burning appliances, including fireplaces and mechanically exhausted appliances. Occupant loading shall be based on the number of bedrooms as follows: first bedroom, two persons; each additional bedroom, one person. Where higher occupant loadings are known, they shall be used.
Kitchens <sup>b</sup>	100 cfm (50 L/s) intermittent or 25 cfm (12 L/s) continuous or openable windows	Installed mechanical exhaust capacity <sup>c</sup> . Climatic conditions may affect choice of the ventilation system.
Baths, <sup>b</sup> Toilets <sup>b</sup>	50 cfm (25 L/s) intermittent or 20 cfm (10 L/s) continuous or openable windows	Installed mechanical exhaust capacity <sup>c</sup> .
Garages: Separate for each dwelling unit	100 cfm (50 L/s) per car	Normally satisfied by infiltration or natural ventilation
Common for several units	1.5 cfm/ft <sup>2</sup> (7.5 L/s · m <sup>2</sup> )	See "Enclosed parking garages," Table 2.1

<sup>a</sup> In using this table, the outdoor air is assumed to be acceptable.

<sup>b</sup> Climatic conditions may affect choice of ventilation option chosen.

<sup>c</sup> The air exhausted from kitchens, bath, and toilet rooms may utilize air supplied

through adjacent living areas to compensate for the air exhausted. The air supplied shall meet the requirements of exhaust systems as described in 5.8 and be of sufficient quantities to meet the requirements of this table.

Table from NZS 4303.1990

### Fan size and air flow

Door undercuts, air grilles or acoustic door head details will be required for both systems, to allow air to flow between rooms. These are also a requirement of G4/AS1.

### Negative pressure systems

- ☑ Are the vents suitably sized to provide sufficient make up air?
- ☑ Is the fan sized suitably to provide sufficient extract volume? Advice should be sought from fan suppliers to ensure fan pressures are adequate for the system design.
- ☑ Has the flow rate been based on the products, or the system as a whole? Duct lengths and bends can impact the overall performance.
- ☑ Consider each room and the airflow pathway - is there a continuous route from a make up air intake vent or trickle vent, to an extract fan through all spaces?
- ☑ Will the noise of the fan be mitigated, or will it transfer down ducts?

### Balanced pressure systems

- ☑ Is the unit sized correctly for the air volume of the house & the occupancy levels?
- ☑ Have you included noise attenuators?

**Table 2:** Total required equivalent aerodynamic area per space (mm<sup>2</sup>)  
Paragraph 1.3.5

Ventilator locations	Number of occupants				
	1	2	3	4	5
High and low level	4000	8000	12,000	16,000	20,000
High level only	3000	6000	9000	12,000	15,000

Table from G4/AS1

## Location

### Negative pressure systems

- ✔ Keeping extract fans up high will remove hot air where it is likely to form
- ✔ Keeping trickle vents and passive intake vents up high will reduce the potential for user interference, encourage better mixing and result in less complaints from users about drafts.

### Balanced pressure systems

- ✔ Keep the intake and extract ducts between the unit and the exterior envelope as short as possible to mitigate heat loss through the duct and reduce potential for condensate to form on the outside of ducting
- ✔ Keep the unit as central as possible in the building to enable the ducts to be similar lengths, but also close to an external wall.

## Allow space

With decentralised ventilation systems, you only have some extra penetrations in your walls or ceilings. However, with MVHR these fans also contain a heat recovery core which adds width to the unit. For this reason you may need to allow for internal boxing or cabinetry, or an external cowl.

For ducted or centralised ventilation systems there will be potentially a large number of ducts to allow space for. Negative pressure systems potentially have ducts from 150mm to over 200mm which can fit in the roof void. However, risers and bulkheads will be required for multi-storey buildings.

Balanced pressure systems usually have ducts between 75-90mm. These can potentially fit within standard wall framing, but must be inside the thermal envelope, so dropped ceilings and wall services cavities will be required. The number of ducts can build up too, so don't underestimate the amount of space needed!

Balanced pressure systems also require noise attenuators, which prevent fan noise from the unit travelling down the ducts, but also reduces 'cross talk' where sound from each room can be transferred to another down the ducts. These usually also form the manifold, where the single large duct from the unit splits into multiple smaller supply ducts, and can be 600x500x150mm, 1200x500x150mm or larger, depending on the system and unit requirements.

## Duct runs

The straighter and shorter the ducts, the less surface resistance there is on the air, and the less the pressure will drop, so you will get higher performance.

- ✔ Keep ducts as straight as you can
- ✔ Keep any bends as gradual as you can
- ✔ Keep ducts as short as you can - but less than 5m may result in additional noise transfer in balanced systems
- ✔ A caveat to this is to keep ducts similar lengths - if there is a big difference between the longest and shortest ducts, there may be a big pressure difference.

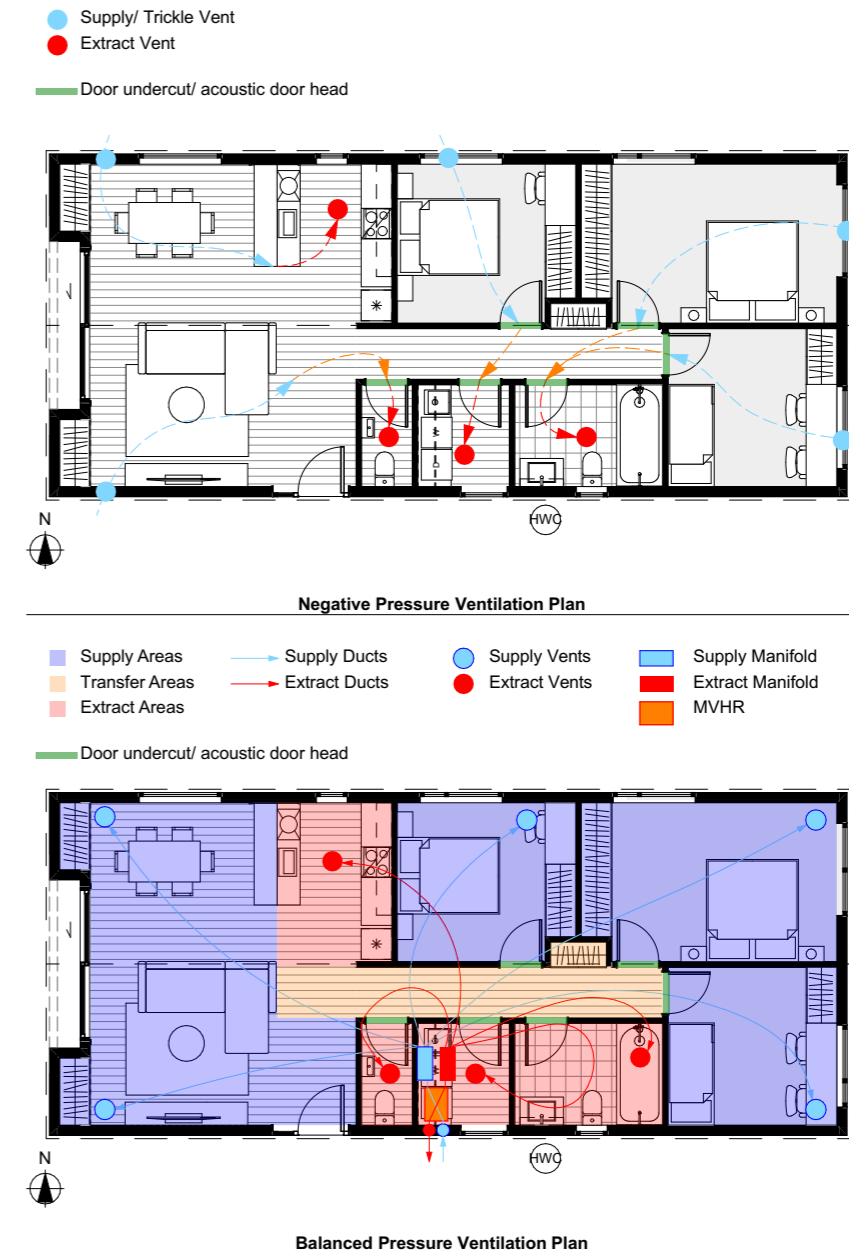

Example negative pressure and balanced pressure system layouts for Case Study 1 and 2



## Commissioning

A system is only as good as its installation quality, and you can only assess this by commissioning the system.

This involves measuring the flow rates of the supply and extract air at the vents to ensure they meet the required volumes. Air flow monitors are placed over the various intake and extract vents and their flow rate measured, and any required tweaks undertaken.

## Maintenance

All ventilation systems will require maintenance - checking ducts, cleaning, replacing filters, etc. So care must always be taken to ensure all elements of the system are readily accessible.

## Product and system availability

There are a range of products and suppliers for both negative pressure and balanced pressure systems in New Zealand. Ask the following questions when specifying them.

Is the efficiency quoted for the components on their own, or in a system as installed?

Will the fan speeds be sufficient in the installed system?

## Kitchen extract hood

This is a separate entity to whole house ventilation. This is due to the hood operating at much higher flow rates than required for ventilation, as it needs to remove moisture, smells and cooking oils as soon as it can. This can be dealt with in two ways:

### An extract hood ducted to the exterior

- ✔ This is fine in negative pressure systems, as make up air can be drawn in through the trickle vents and passive intake vents.
- ✔ In balanced pressure systems, make up air must be provided either by opening a window every time you turn the hood on, or by including an additional intake vent to provide make up air, with airtight dampeners.

### A recirculating extract hood

- ✔ This removes the oils and smells (but not moisture) at source and recirculates the air back into the building. This is an easier approach for balanced ventilation systems as you do not need to provide make up air. However, as with all rangehoods, filters need to be cleaned regularly. Moisture from cooking, washing up and kettles still needs to be dealt with effectively, which will influence the design of the system and in particular location of extracts in the kitchen.



An example of a passive intake vent with a replaceable filter, for use with a negative pressure ventilation system instead of, or as well as, trickle vents.



The importance of straight duct runs!

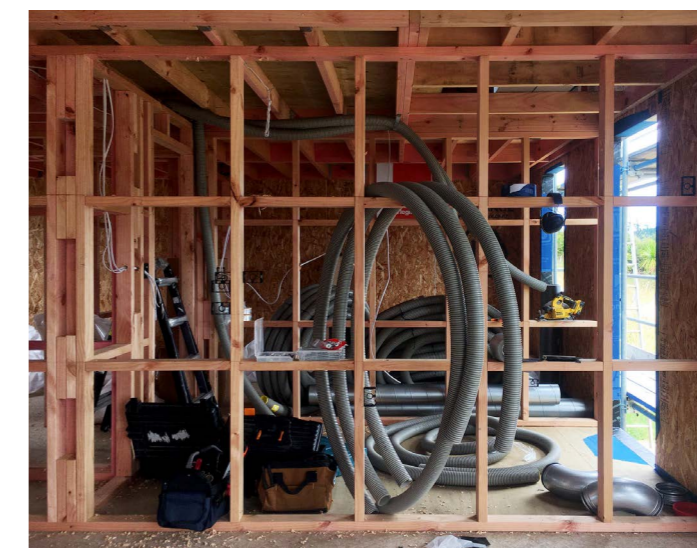

70mm flexible ducts for a balanced mechanical ventilation system - mid-install



## A worked ventilation example

In this example we will use case study 01 and design a ventilation system for it.

### What system?

We are aiming for 7 Homestar so can utilise a continuous negative pressure system. To minimise the amount of penetrations in the envelope, and the amount of fans required, we will use a centralised system with a single fan, ducts to the wet extract areas, and passive intake vents for the make up air.

### Where?

As it's a negative pressure system, the ducts and the fan unit can be outside the thermal envelope, perhaps in the loft space. It will need to be accessible for maintenance and inspection so a full sized, insulated and airtight loft access hatch should be included in the project. The ducts will be around 150mm in diameter.

The passive intake vents will go in the bedrooms and living spaces, positioned furthest away from the interior doors to minimise any dead spots where the fresh air won't get to. If they're higher up on the wall, it's less likely the users will experience draughts.

### Work out the extract flow rates

We need to work out the interior air volume of the building. This can be done by multiplying the floor area by the stud height, or can be worked out in 3D BIM for more complex buildings. The air volume for this building is  $252.28\text{m}^3$ , so to achieve 0.35 air changes per hour the flow rate needs to be at least  $88.3\text{m}^3/\text{hour}$ , which is  $24.5\text{L}/\text{second}$ .

We also need to assess how many people will be using the building. As this is a 3 bedroom home, we will assume four people will be living there. According to the NZS 4303.1990 the supply rates need to be:

- 7.5L/second per person is required from living spaces, so 30L/second for four people

The minimum continuous extract demand is:

- 12L/second for the kitchen plus 10L/second each for the bathroom, laundry and WC.

This totals 42L/second extract rate, which is  $151.2\text{m}^3/\text{hour}$ . As this is greater than the 0.35ach and 30L/second rates, this is the flow rate we must design for, and the minimum flow rate the selected extract fan must achieve.

## Work out the supply volume

Now we know the extract volume and rates, we need to ensure there is sufficient provision for make up air, to ensure there is no pressure on the building envelope.

G4/AS1 paragraph 1.3.5 and table 2 state the minimum supply area size for supply vents based on occupancy. For 4 occupants and high level vents,  $12,000\text{mm}^2$  ( $0.012\text{m}^2$ ) must be provided:

- A typical passive vent available in NZ provides  $3,000\text{mm}^2$  equivalent aerodynamic area, so four would suffice.

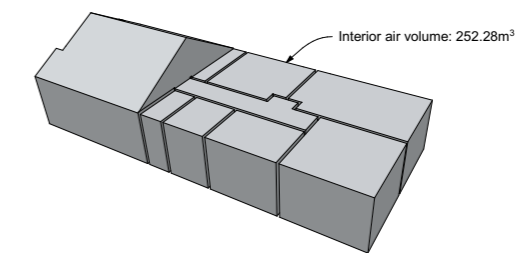

Interior air volume

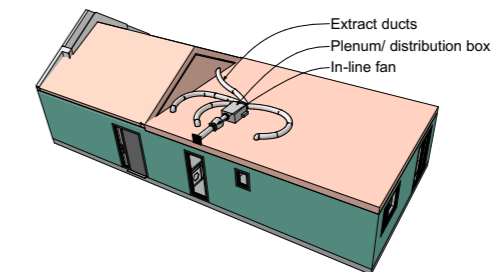

Ventilation system

- Supply/ Trickle Vent
- Extract Vent
- Extract fan in roof space - extract to eave or through roof
- Duct runs in roof space
- Door undercut/ acoustic door head

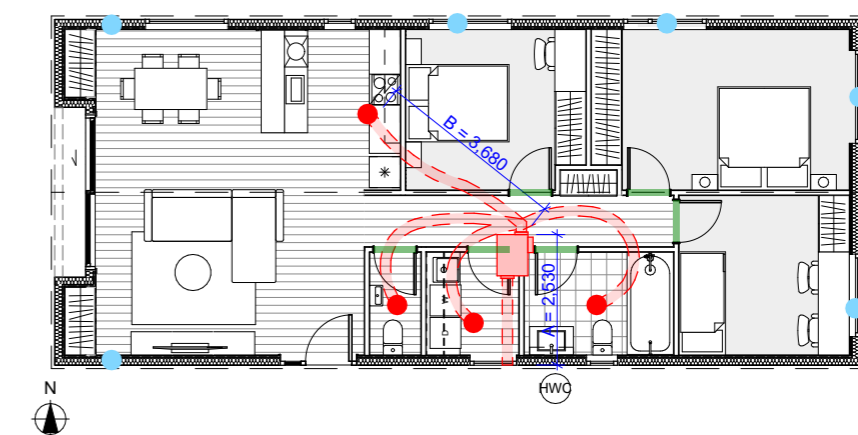

Worked ventilation plan

## A worked ventilation example (cont.)

- ☐ G4/AS1 requires trickle vents to have a minimum of 2,000mm<sup>2</sup> equivalent aerodynamic area, and a 10x300mm trickle vent would provide 3,000mm<sup>2</sup>.

$$4 \times \text{trickle vents} = 12,000\text{mm}^2 \text{ (10mm x 300mm each)}$$

$$9 \times \text{trickle vents} = 27,000\text{mm}^2 \text{ (10mm x 300mm each)}$$

- ☐ A combination of in-wall passive vents and trickle vents could be specified.

A minimum of 10mm door undercuts, acoustic door heads or vent grills between all rooms must also be included.

### Duct runs and pressure drop

As the air flows through the ducts, the friction causes the pressure to drop. To ensure the fan extract rate is achieved, the ducts will need to be as straight as possible, and around equal lengths to prevent too much pressure drop. For this case study, this is quite easy to achieve as we have a roof void to run the ducts in. However, we still need to account for the pressure drop to size the fan.

### To calculate the pressure drop:

- Step 1: Work out the length of the duct from the exterior grill to the plenum box (A) and the length of the longest duct (B) and add them together
- Step 2: Use a duct pressure drop calculator (available online) and input the air volume, duct diameter, duct length (A+B) duct type, and any grilles or bends to calculate the pressure drop
- Step 3: Plot the calculated pressure drop against the fan performance curve sourced from the supplier, to show you what volume flow the fan will need to provide.
- Step 4: Select a fan that is speed controllable to enable the correct speed to be selected, to provide the required flow rate

Some suppliers have fan selectors on their websites to help.

### As built performance

A final step would be to commission the system. While this isn't yet a requirement for 7 Homestar projects it is strongly recommended, to assess whether the system is performing as designed.

These principles should provide a starting point, to enable designers to specify simple systems, and incorporate best practice design elements when specifying residential ventilation systems. For more complex systems it is recommended to engage a ventilation supplier or mechanical engineer, at an early stage in the design process.

Enter the Volume required (in Blue box)

Select the units entered from the Drop Down Menu (in Yellow box)

Enter the number of required items (in Purple Boxes)

Duct Diameter (mm)	Volume	Vel in m/s
150	42 l/s	2.38

Enter the Duct Dia, the Air Volume and Units used above

	Quantity	Resistance
Lengths of Spiral in m	6.21	2.6
90° Bends - Segmented	1	1.2
90° Bends - Pressed		0.0
45° Bends - Segmented		0.0
45° Bends - Pressed		0.0
Fully Extended Flex in m		0.0
90° Flexible Bend		0.0
Reducer (depends on amount)		0.0
Saddle (50% of Main)		0.0
Curved Boot (50% of Main)		0.0
Tee (supply from branch)		0.0
Y Piece		0.0
Duct Heater		0.0
Attenuator - 600mm long	1	1.2
Filter Cassette (Clean)		0.0
Air Valves & Diffuser*	1	35.0
EC / SD / DD Grille*		0.0
Weather Louvre**	1	33.0
<b>TOTAL RESISTANCE (in Pascals) =</b>		<b>73.01</b>

An example system pressure drop calculator



## Performance Curve - TD-500/150

Duty Selected: Volume Flow: 0.042 m<sup>3</sup>/sec Static Pressure: 73 Pa

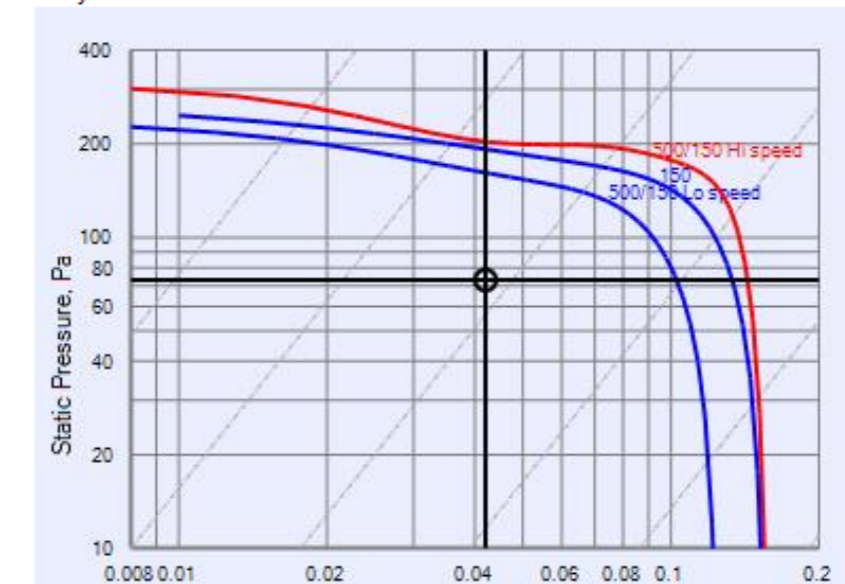

A fan performance curve - plot the calculated pressure drop against the volume flow rate to allow you to select a suitable fan.

# Glossary

Air and vapour control layer (AVCL)	This is a layer designed to control the air and vapour flow through a building assembly. Examples include specialist membranes and taped plywood or oriented strand board (OSB).
Air changes	The number of times that the total air volume in a home is completely removed and replaced with outdoor air, usually expressed per hour.
Airtightness	An assessment of the amount of unintended air leaks in the building envelope. Homestar uses the envelope area (Air permeability qE50 from ISO9972) as a reference for airtightness: m <sup>3</sup> of air loss per m <sup>2</sup> of envelope per hour @ 50pa pressure.
Annual electricity demand	'Delivered' energy includes everything associated with operational energy - excludes plug loads/appliances. It takes into account efficiency of any systems (e.g. demand might be 30 kWh/m <sup>2</sup> /yr, but using a heat pump with COP=3 means delivered energy is only 10 kWh/m <sup>2</sup> /yr).
Annual space heating demand/ heat demand	The amount of energy required to keep the building interior at a specified temperature.
Balanced ventilation	A balanced pressure ventilation system uses two fans to bring in the same amount of air as it removes. This ensures there is no pressure on the building envelope so no air is pushed or pulled through the building fabric.
Building performance	In the context of this guide this refers to the overall energy efficiency, user comfort and long-term durability of a building.
Climate zone	Designation of areas within New Zealand that share similar climatic characteristics.
CLT	Cross laminated timber - a form of mass timber construction.
Cold roof	Conventional New Zealand roof build-up where the structure of the roof (e.g. the rafters) is outside the thermal envelope.
Conditioned floor area (CFA)	Space within the thermal envelope of the dwelling that could maintain a temperature band of between 20-25°C for 365 days of the year. Refer to the Homestar Technical Manual for more details.
Continuous extract ventilation	Whole-dwelling ventilation system that extracts air continuously at a low rate.
Decentralised ventilation	A ventilation system that uses several fans in different locations to deliver and remove air in a building.
Ducted ventilation	A ventilation system that uses ducts to deliver and remove air in a building, with a single central fan unit.
ECCHO	The Homestar® energy analysis tool, ECCHO (Energy and Carbon Calculator for Homes), is a web app that allows users to calculate the heating and cooling demand, energy consumption, overheating risk, and carbon emissions of a home.
Embodied carbon	Embodied carbon is the carbon dioxide (CO <sub>2</sub> ) emissions associated with materials and construction processes throughout the whole lifecycle of a building or infrastructure.
Energy balance	The assessment of the amount of energy lost through the thermal envelope vs the amount of energy gained, with the difference made up by heating or cooling to maintain a balance.
Energy/ thermal modelling	Energy modelling of buildings is a process that uses computer software to simulate how a building will consume energy based on its design, materials, and systems.
EPD	Environmental Product Declaration, used to determine the environmental footprint of a product following life cycle assessment, verified independently.
Form factor	The ratio of total external surface area of the thermal envelope (including the floor slab area) to the conditioned floor area. Typically, a large building will have a lower form factor than a smaller one. A simpler shape will also have a lower form factor than a more complex shape. The lower the number, the less insulation needed in the same climate (everything else being equal).
Frequency of overheating	The amount of time in a year the interior spends at 25°C or above. Note this can assume night and window ventilation, so if the building is modelled with more ventilation than used in practice it may overheat more than predicted.

fRsi	Temperature factor. Value between 0 and 1 that expresses how cold the inside surface of a junction is likely to get. The lower the number the higher the risk of mould. Numerically this is the difference between the interior surface temperature and the exterior air temperature, divided by the average temperature difference between interior and exterior.
g-value	Fraction of solar heat energy that enters a building compared to that which hits the outside of the glazing unit. Roughly equivalent to Solar Heat Gain Coefficient (SHGC) which is sometimes published instead for glazing units.
Heat loss area	The exterior area of the building that is between interior heated space and the exterior air, through which heat is lost - generally the walls, floor, roof and windows of a building. If a building is joined to another building, the adjoining area is not a heat loss area as it is attached to another heated space.
HECC	The Homestar Embodied Carbon Calculator developed by BRANZ for NZGBC, an easy to use tool for estimating the embodied carbon content of a typical home.
HPCDH	The High Performance Construction Details Handbook, a document that covers a wide range of typical thermal bridges, assemblies and build-ups used in New Zealand, produced by Passive House Institute New Zealand, BRANZ and Jason Quinn.
HVAC	Heating, ventilation, and air conditioning systems.
Hygrothermal modelling	Hygrothermal modelling uses a computer program to model the long-term effects of heat and moisture within and through parts of a building and assesses interstitial condensation risks.
Internal heat gain	The heating in a building from its occupants and the use of appliances within the thermal envelope.
kgCO <sup>2</sup> -e/m <sup>2</sup>	Kilograms of carbon dioxide equivalent per square metre (of the home). A measurement of embodied carbon.
kWh	Kilowatt hour, a unit of energy. A 2kW portable heater on for one hour would use 2kWh (2000Wh) of energy. 1kWh = 3.6MJ (megajoules). A 1m <sup>2</sup> window in direct sunlight allows approximately 1kW of energy into the home.
kWh/m <sup>2</sup> /year (sometimes abbreviated to kWh/m <sup>2</sup> )	Kilowatt hours per m <sup>2</sup> per year. Measures the space heating demand compared with the usable or conditioned floor area (CFA in Homestar <sup>®</sup> v5, measured externally of the insulation; ICA or internal conditioned area in v4.1, measured internally of the insulation).
Life cycle assessment	Life cycle assessment (LCA) calculates the environmental footprint of a product or service over its lifecycle. LCA tools include HECC (for embodied energy only - see above), the BRANZ LCAquick tool and ETOOL LCD.
Low-e coatings	Low emissivity coating, most commonly on glass surfaces between double or triple pane windows. Low emissivity coatings reduce heat transfer by lowering the level of infrared radiation transmission. They achieve this by reflecting IR radiation and work best if there is both a physical gap and the coating is not covered with dirt or condensation (which is why they are commonly used in the sealed environment between glass panes). There are many types of low-e coatings and the thermal performance can vary significantly between them.
Mandatory minimum	Each Homestar <sup>®</sup> star band has a set of mandatory minimums that must be met. These dictate the performance levels we are aiming to achieve in each climate zone with each typology.
Mechanical ventilation with heat recovery (MVHR)	Also known as heat (or in some applications, energy) recovery ventilation or comfort ventilation. A whole-house ventilation system that exchanges heat between the exhaust air and the supply air. Fresh air is typically delivered to living areas (e.g. living room and bedrooms) and extracted from kitchens and bathrooms. MVHR units do not necessarily supply additional heat into the supplied air. However, a supply duct radiator, heat pump or electric coil can be used to add heat or coolth to the new air before or after it leaves the MVHR unit.
Negative pressure ventilation	A mechanical ventilation system that uses fans to remove the air within the building and de-pressurize it, pulling make up air into the building through trickle vents and open windows.
Positive pressure ventilation	A mechanical ventilation system that uses fans to push air into the building, pressurizing it. The air is then forced out of the building through any gap it can find. Positive pressure systems are not acceptable at any Homestar level.
psi value	Measure of heat loss ('thermal bridging') within a junction of two thermal elements, measured in W/mK. Represents the rate at which heat passes through a junction per metre per Kelvin temperature difference [W/m/K]: for example, the junction between two walls forming an external corner. The length of the junction (ie height of the corner) is multiplied by the psi value to calculate the heat loss coefficient for that corner.



R-value (m <sup>2</sup> K/W)	Thermal resistance rating used to determine a material or assembly's ability to resist heat flow.
S/V	Surface to volume ratio - an assessment of the compactness of the building form.
Service cavity	A service cavity is a secondary cavity (that may or may not be insulated) usually to the inside of the structural elements and the AVCL (air and vapour control layer). It contains the wiring, plumbing etc to keep penetrations of the AVCL to a minimum. The service cavity is usually but not necessarily insulated. Commonly, the AVCL is tested for air leakage before insulating the service cavity or installing the interior finish.
Shading factor	A measure of how much solar heat gain enters through a window compared to an unshaded window.
Structural Insulated Panel (SIP)	A panellised off-site construction building system. The panels consist of an insulating foam core sandwiched between two structural facings, typically oriented strand board (OSB). The panels are cut to size in the factory and are delivered to site.
Thermal bridge	A location in the thermal envelope where the uniform thermal resistance is changed by higher conductivity materials or geometry change.
Thermal conductivity	A material's ability to transmit heat is measured by the thermal conductivity (or lambda value). Unlike R-value, the thermal conductivity of a material remains the same irrespective of the thickness of the material.
Thermal envelope	The surfaces that enclose the building's conditioned spaces, which may or may not include garages. This includes the floor area to the exterior. For tools such as ECCHO and PHPP, external dimensions are used. This means from the bottom of the insulation below the concrete slab to the top of the insulation in the ceiling.
Thermal mass	The ability of a body of material to absorb, store and subsequently release heat (due to its specific heat capacity and its mass).
Transmission heat loss	The loss of heat energy via the building components of the house.
Upfront carbon	The carbon emitted in the production phase of products and materials, from mining and processing of natural resources, transport to processing sites, and the manufacturing phases, before any construction begins.
U-value (W/m <sup>2</sup> K)	Thermal conductance, the inverse of thermal resistance (R-value). Describes the heat flow per m <sup>2</sup> of an assembly per degree Kelvin.
Ug-value	U-value at the centre of a pane of glass. Note that this is not the U-value of an entire window (U <sub>w</sub> ) which must be calculated to include the balances of losses through the glass and frame.
VLT	Visible light transmission. VLT is expressed as the percentage of light allowed through the glass.
Waffle pod	A structural slab system that is made up of concrete ribs with plastic or polystyrene pods between, and a concrete slab on top.
Warm roof	A roof build up where the insulation is on the exterior of the structure.
WRB	Water resistive barrier. This is typically the flexible wall underlay but this can be the top layer of a rigid air barrier product used under the ventilated rain-screen cladding. Used to designate the control layer in the building assembly that is intended to stop rainwater entry.

